

OPERATING AND SERVICE MANUAL

SWEEP OSCILLATOR

8690B

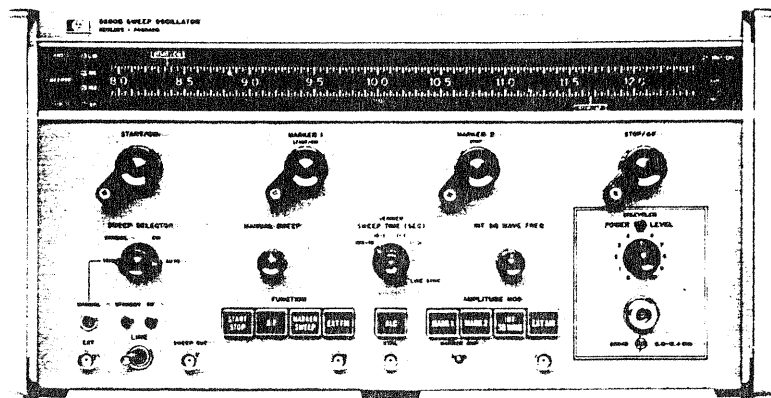

HEWLETT  PACKARD

SAFETY CONSIDERATIONS

Safety Symbols



Instruction manual symbol: the apparatus will be marked with this symbol when it is necessary for the user to refer to the instruction manual in order to protect the apparatus against damage.



Indicates dangerous voltages.



Earth terminal (sometimes used in manual to indicate circuit connected to grounded chassis).

WARNING

The **WARNING** sign denotes a hazard. It calls attention to a procedure, practice, or the like, which, if not correctly performed or adhered to, could result in injury or loss of life. Do not proceed beyond a **WARNING** sign until the indicated conditions are fully understood and met.

CAUTION

The **CAUTION** sign denotes a hazard. It calls attention to an operating procedure, practice, or the like, which, if not correctly performed or adhered to, could result in damage to or destruction of part or all of the equipment. Do not proceed beyond a **CAUTION** sign until the indicated conditions are fully understood and met.

Operation

CAUTION

BEFORE APPLYING POWER make sure the instrument's ac input is set for the available ac line voltage, that the correct fuse is installed, and that all normal safety precautions have been taken.

Service

The information, cautions, and warnings in this manual must be followed to ensure safe operation and to keep the instrument safe. **SERVICE AND ADJUSTMENTS SHOULD BE PERFORMED ONLY BY QUALIFIED SERVICE PERSONNEL.**

Adjustment or repair of the opened instrument with the ac power connected should be avoided as much as possible and, when unavoidable, should be performed only by a skilled person who knows the hazard involved.

Capacitors inside the instrument may still be charged even though the instrument has been disconnected from its source of supply.

Make sure only fuses of the required current rating and type (normal blow, time delay, etc.) are used for replacement. Fuse requirements are indicated on the instrument's rear panel. Do not use repaired fuses or short-circuit fuse holders.

Whenever it is likely that the protection has been impaired, make the instrument inoperative and secure it against any unintended operation.

WARNING

If this instrument is to be energized through an auto-transformer (for voltage reduction), make sure the common terminal is connected to the earthed pole of the power source.

BEFORE SWITCHING ON THE INSTRUMENT, the protective earth terminal of the instrument must be connected to the protective conductor of the (mains) power cord. The mains plug shall only be inserted in a socket outlet provided with protective earth contact. The protection action must not be negated by using an extension cord (power cable) without a protective grounding conductor. Grounding one conductor of a two-conductor outlet is not sufficient protection.

Any interruption of the protective (grounding) conductor, inside or outside the instrument, or disconnection of the protective earth terminal is likely to make this instrument dangerous. Intentional interruption of the earth ground is prohibited. Whenever it is likely that the protection has been impaired, the instrument must be secured against any unintended operation.

Servicing this instrument often requires that you work with the instrument's protective covers removed and with ac power connected. Be very careful; the energy at many points in the instrument may, if contacted, cause personal injury.

MANUAL CHANGES

MANUAL IDENTIFICATION

Model Number: 8690B
 Date Printed: May 1972
 Part Number: 08690-90018

This supplement contains important information for correcting manual errors and for adapting the manual to instruments containing improvements made after the printing of the manual.

To use this supplement:

Make all ERRATA corrections

Make all appropriate serial number related changes indicated in the tables below.

Serial Prefix or Number	Make Manual Changes	Serial Prefix or Number	Make Manual Changes
1114A	1, 2	1513A05546 thru	1, 3 - 13
1124A	1, 3	1513A05605	
1143A02906 thru	1, 2, 4, 5	1513A05606 thru	1, 3 - 14
1143A03055		1513A05695	
1202A03056 thru	1, 3 - 6	1513A05696 thru	1, 3 - 15
1202A04045		1513A prefix	
1202A04046 thru	1, 3 - 7	1646A	1, 3 - 16
1202A04345			
1202A04346 thru	1, 3 - 8	1651A	1, 3 - 17
1202A04585			
1349A04586 thru	1, 3 - 9	1718A	1, 3 - 18
1349A05215			
1349A05216 thru	1, 3 - 10	▶ 1718A06386 thru	1, 3 - 19
1349A05275		1718A prefix	
1445A	1, 3 - 11		
1513A05426 thru	1, 3 - 12		
1513A05545			

▶ NEW ITEM

ERRATA

Inside front cover:

Insert new information regarding SAFETY, CERTIFICATION, and WARRANTY AND ASSISTANCE immediately inside front cover of manual (new information sheet supplied in this Manual Changes Supplement).

Page 1-1. General Information:

Add the attached Paragraph 1A preceding Paragraph 1-1:

NOTE

Manual change supplements are revised as often as necessary to keep manuals as current and accurate as possible. Hewlett-Packard recommends that you periodically request the latest edition of this supplement. Free copies are available from all HP offices. When requesting copies quote the manual identification information from your supplement, or the model number and print date from the title page of the manual.

24 OCTOBER 1978

20 Pages

Printed in U.S.A.

HEWLETT  PACKARD

SAFETY

This instrument has been designed and tested according to International Safety Requirements. To ensure safe operation and to keep the instrument safe, the information, cautions, and warnings in this manual must be heeded. Refer to Section I for general safety considerations applicable to this instrument.

CERTIFICATION

Hewlett-Packard Company certifies that this instrument met its published specifications at the time of shipment from the factory. Hewlett-Packard Company further certifies that its calibration measurements are traceable to the United States National Bureau of Standards, to the extent allowed by the Bureau's calibration facility, and to the calibration facilities of other International Standards Organization members.

WARRANTY AND ASSISTANCE

This Hewlett-Packard product is warranted against defects in materials and workmanship for a period of one year from the date of shipment. Hewlett-Packard will, at its option, repair or replace products which prove to be defective during the warranty period provided they are returned to Hewlett-Packard, and provided the proper preventive maintenance procedures as listed in this manual are followed. Repairs necessitated by misuse of the product are not covered by this warranty. NO OTHER WARRANTIES ARE EXPRESSED OR IMPLIED, INCLUDING BUT NOT LIMITED TO THE IMPLIED WARRANTIES OF MERCHANTABILITY AND FITNESS FOR A PARTICULAR PURPOSE. HEWLETT-PACKARD IS NOT LIABLE FOR CONSEQUENTIAL DAMAGES.

Service contracts or customer assistance agreements are available for Hewlett-Packard products that require maintenance and repair on-site.

For any assistance, contact your nearest Hewlett-Packard Sales and Service Office. Addresses are provided at the back of this manual.

1-A. SAFETY CONSIDERATIONS

Safety Symbols



Instruction manual symbol: the apparatus will be marked with this symbol when it is necessary for the user to refer to the instruction manual in order to protect the apparatus against damage.



Indicates dangerous voltages.



Earth terminal (sometimes used in manual to indicate circuit connected to grounded chassis).

WARNING

The **WARNING** sign denotes a hazard. It calls attention to a procedure, practice, or the like, which, if not correctly performed or adhered to, could result in injury or loss of life. Do not proceed beyond a **WARNING** sign until the indicated conditions are fully understood and met.

CAUTION

The **CAUTION** sign denotes a hazard. It calls attention to an operating procedure, practice, or the like, which, if not correctly performed or adhered to, could result in damage to or destruction of part or all of the equipment. Do not proceed beyond a **CAUTION** sign until the indicated conditions are fully understood and met.

Operation

CAUTION

BEFORE APPLYING POWER make sure the instrument's ac input is set for the available ac line voltage, that the correct fuse is installed, and that all normal safety precautions have been taken.

Service

The information, cautions, and warnings in this manual must be followed to ensure safe operation and to keep the instrument safe. **SERVICE AND ADJUSTMENTS SHOULD BE PERFORMED ONLY BY QUALIFIED SERVICE PERSONNEL.**

Adjustment or repair of the opened instrument with the

ac power connected should be avoided as much as possible and, when unavoidable, should be performed only by a skilled person who knows the hazard involved.

Capacitors inside the instrument may still be charged even though the instrument has been disconnected from its source of supply.

Make sure only fuses of the required current rating and type (normal blow, time delay, etc.) are used for replacement. Fuse requirements are indicated on the instrument's rear panel. Do not use repaired fuses or short-circuit fuse holders.

Whenever it is likely that the protection has been impaired, make the instrument inoperative and secure it against any unintended operation.

WARNING

If this instrument is to be energized through an auto-transformer (for voltage reduction), make sure the common terminal is connected to the earthed pole of the power source.

BEFORE SWITCHING ON THE INSTRUMENT, the protective earth terminal of the instrument must be connected to the protective conductor of the (mains) power cord. The mains plug shall only be inserted in a socket outlet provided with protective earth contact. The protection action must not be negated by using an extension cord (power cable) without a protective grounding conductor. Grounding one conductor of a two-conductor outlet is not sufficient protection.

Any interruption of the protective (grounding) conductor, inside or outside the instrument, or disconnection of the protective earth terminal is likely to make this instrument dangerous. Intentional interruption of the earth ground is prohibited. Whenever it is likely that the protection has been impaired, the instrument must be secured against any unintended operation.

Servicing this instrument often requires that you work with the instrument's protective covers removed and with ac power connected. Be very careful; the energy at many points in the instrument may, if contacted, cause personal injury.

ERRATA (Cont'd)

Page 5-12, Table 5-2:

Add the following performance test:

28. External Trigger

PROCEDURE:

- a. Connect equipment as shown in Figure 5-3, according to RF Unit used. Omit connections A and C. Switch sweep oscillator connection B from EXT AM connector to EXT trigger connector.
- b. Set 8690B SWEEP SELECTOR switch to TRIG position.
- c. Set square wave generator for a 50 Hz output and increase square wave amplitude until sweep oscillator triggers sweep ramp.
- d. TEST LIMIT: Check square wave generator output on oscilloscope is less than 25 volts peak-to-peak.

Page 6-2, Table 6-1:

- Change A2C3 to HP Part No. 0160-2675 C: FXD MICA 3900 pF 1% 300 VDCW, Factory selected part.
- Change A2R8 to HP Part No. 2100-0672 R: VAR COMP 2K OHM 20% LIN 1/2W
- A2R19 to HP Part No. 2100-0674 R: VAR COMP 20K OHM 20% LIN 1/2W
- A2R22 to HP Part No. 2100-0673 R: VAR COMP 5K OHM 20% LIN 1/2W
- A2R23 to HP Part No. 2100-0673 R: VAR COMP 5K OHM 20% LIN 1/2W
- A2R24 to HP Part No. 2100-0673 R: VAR COMP 5K OHM 20% LIN 1/2W
- A2R25 to HP Part No. 2100-0672 R: VAR COMP 2K OHM 20% LIN 1/2W
- A2R28 to HP Part No. 2100-0676 R: VAR COMP 50K OHM 20% LIN 1/2W

Page 6-3, Table 6-1:

- Change A2R30 to HP Part No. 2100-0673 R: VAR COMP 5K OHM 20% LIN 1/2W
- A2R31 to HP Part No. 2100-0673 R: VAR COMP 5K OHM 20% LIN 1/2W
- Add as a second A3 entry HP Part No. 08690-60066 Replacement Kit Reciprocal Amplifier Board Assembly.

Page 6-4, Table 6-1:

- Change A3R53 to HP Part No. 2100-0674 R: VAR COMP 20K OHM 20% LIN 1/2W.
- Change A3R60 to HP Part No. 0699-0225, RESISTOR 147K 2% 2W MO TC=0 ±200.

Page 6-5, Table 6-1:

- Add as a second A4 entry HP Part No. 08690-60063 Replacement Kit Helix Amplifier Board Assembly.

Page 6-7, Table 6-1:

- Add A4XV6 HP Part No. 1200-0062 SOCKET: TUBE 9 PIN.
- Add as a second A5 entry HP Part No. 08690-60065 Replacement Kit Low Voltage Power Supply Board Assembly.

Page 6-8, Table 6-1:

- Add as a second A6 entry HP Part No. 08690-60064 Replacement Kit Regulator Board Assembly.

Page 6-10, Table 6-1:

- Add as a second A8 entry HP Part No. 08690-60071 Replacement Kit High Voltage Power Supply Board Assembly (not pretested).
- Add A8XV2 and A8XV3 HP Part No. 1200-0053 SOCKET: TUBE 7 PIN.
- Add as a second A9 entry HP Part No. 08690-60061 Replacement Kit Rectifier Board Assembly (not pretested).

ERRATA (Cont'd)

Page 6-11, Table 6-1:

Change A9K2 HP Part Number to 0490-0659.

Add A9MP1, MP2, HP Part No. 1205-0011 Heat Sink.

Add as a second A10 entry HP Part No. 08690-60059 Replacement Kit Sweep Generator Board Assembly.

▶ Add CR6, 1901-0028, DIODE: SILICON 400 PIV 0.5 AMP.

Page 6-12, Table 6-1:

▶ Change A10R11 to 0698-3655, R:FXD MET OX 56K OHM 5% 2W.

Page 6-13, Table 6-1:

Change A11R2 to HP Part No. 2100-0675 R: VAR COMP 25K OHM 20% LIN 1/2W

A11R8 to HP Part No. 0757-0128 R:FXD MET FLM 200K OHM 1% LIN 1/2W

A11R18 to HP Part No. 2100-0675 R: VAR COMP 25K OHM 20% LIN 1/2W

Page 6-14, Table 6-1:

Add as a second A12 entry HP Part No. 08690-60062 Replacement Kit ALC Amplifier Board Assembly.

Add A12XV1 HP Part No. 1200-0062 SOCKET: TUBE 9 PIN

Page 6-15, Table 6-1:

Change B1 to HP Part No. 3160-0289 recommended replacement.

Change C1 and C2 to HP Part No. 0160-0669 C:FXD Mylar 2 mf $\pm 10\%$ 2000 VDCW

Page 6-16, Table 6-1:

Change F1 to HP Part No. 2100-0420 FUSE 0.032A 250V

Page 6-17, Table 6-1:

Change XF1 and XF2 to HP Part No. 2110-0464

Add HP Part No. 2110-0465 FUSEHOLDER CAP

Add HP Part No. 2100-0467 NUT-HEX 1/2-28

Add HP Part No. 7120-4162 LABEL INFO QTY 2

Add HP Part No. 7120-4163 LABEL INFO QTY 1

Page 6-18, Table 6-1:

Change HP Part No. 1400-0084 to:

HP Part No. 2110-0464 FUSEHOLDER

Add HP Part No. 2110-0465 FUSEHOLDER CAP

Add HP Part No. 2110-0467 NUT-HEX 1/2-28

Page 6-23, Table 6-2:

Change 0764-0031 to 0698-3655, R:FXD MET OX 56K OHM 5% 2W, 28480, 0698-3655.

Change HP Part No. 1400-0084 to:

HP Part NO. 2110-0464 FUSEHOLDER

Page 7-3, Figure 7-2:

Change value of A10R11 to 56K.

ERRATA (Cont'd)

Page 7-3, Figure 7-2:

Change switch labeling as shown below:

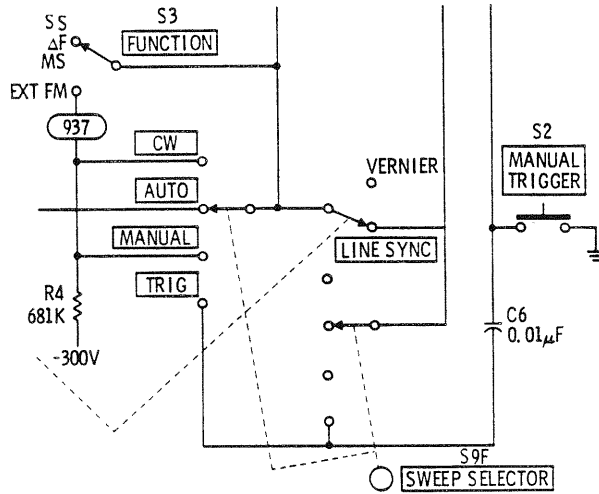

Page 7-5, Figure 7-3:

Change the A3 Assembly Component Identification Photo indicate R74 and R78 designations are swapped.

Change F1 to 0.032A

Change the A3 Assembly Resistor Reference Designations to read R30-34, 40-45, 47-80.

Change the circuitry of A3Q1 as shown in the attached drawing:

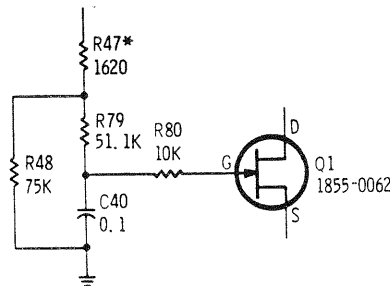

P/O Figure 7-3. Frequency Control Section Reciprocal Amplifier

Page 7-11, Figure 7-6:

Change 95 wire connection between switch S4 and resistor R23 to a connection between R23 and output connector J12.

ERRATA (Cont'd)

Page 7-14 and 7-16. Component Identification, Assembly A9:

Substitute the attached A9 Component Identification board for that shown in the 8690B Manual.

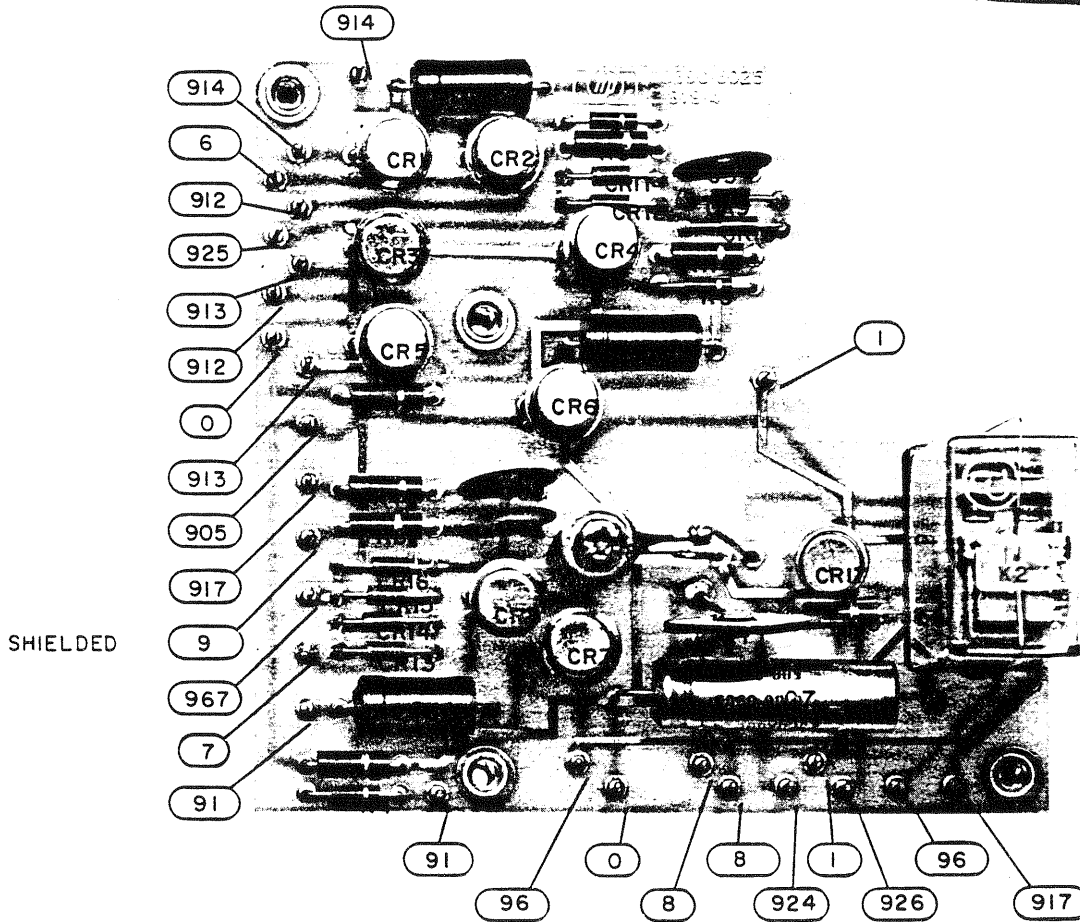

Component Identification. Assembly A9

Page 7-15, Figure 7-8:

Change the wire color code of the wire between XA14 pin 6 and A9CR2, from 913 to 6.

The wire color code of the wire at T2 pin 13, 26 VAC winding, is 913.

► Add diode across K3 terminals and change 924 wire terminal as shown in partial schematic below:

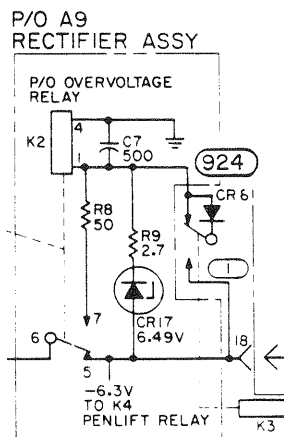

ERRATA (Cont'd)

Page 1-4, Table 1-2, Furnished:

Delete all references to Rack Mounting Kit.

Page 2-2, Paragraph 2-22:

Change to read:

"A Rack Mounting Kit is available to install the instrument in a 19-inch rack. Rack Mounting Kits may be obtained through your nearest Hewlett-Packard Office by ordering HP Part Number 5060-8742."

CHANGE 1

Page 5-17, Table 5-4, Power Supply Adjustment:

Change the power supply adjustment sequence as indicated below:

Old Adjustment Sequence

a, b, c, d, e, f, g, h, i.

New Adjustment Sequence

a, b, c, f, g, h, i, d, e

Page 6-4, Table 6-1:

Add diodes A3CR56, A3CR57 and A3CR58, HP Part No. 1901-0033 DIODE: SILICON 100 mA 180 WV.

Page 6-6, Table 6-1:

Add diode A4CR11, HP Part No. 1902-3400 DIODE: BREAKDOWN 78.7V 2% 400 mW.

Change resistors A10R17/A10R18 to HP Part No. 0698-3136 R: FXD 17.8K 1% 1/8W.

Page 6-10, Table 6-1:

Change A8 Assy to HP Part No. 08690-60053.

Add A8Q2 HP Part No. 1884-0073 THYRISTOR, SCR.

Add Resistor A8R15 HP Part No. 0757-1000 R: FXD MET FLM 51.1 OHM 1% 1/2W.

Add Resistor A8R16 HP Part No. 0757-0280 R: FXD MET FLM 1.0K OHM 1% 1/8W.

Change Capacitor A8C6 to HP Part No. 0180-0183 C: FXD ELECT 10 UF +75 -10% 50 VDCW.

Change A8Q1 to HP Part No. 1855-0010 UNIJUNCTION: SILICON.

Change Resistor A8R13 to HP Part No. 0698-4348 R: FXD MET FLM 4.99M OHM 1% 1/2W.

Change Resistor A8R14 to HP Part No. 0698-3444 R: FXD MET FLM 316 OHM 1% 1/8W.

Page 6-11, Table 6-1:

Change Transistors A10Q3 and A10Q4 to HP Part No. 1853-0020 TRANSISTOR: PNP SILICON (Recommended replacement for 1850-0062).

Pages 6-12, and 6-13, Table 6-1:

Add diode A11CR19 HP Part No. 1901-0033 DIODE: SILICON 100 mA 180 WV.

Change Transistors A11Q2, A11Q3, A11Q4, A11Q6, A11Q7, A11Q8 and A11Q11 to HP Part No. 1853-0020 TRANSISTOR: PNP SILICON (Recommended replacement for 1850-0062).

Page 6-16, Table 6-1:

Add chassis mounted diodes CR6 and CR7 HP Part No. 1901-0033 DIODE: SILICON 100 MA 180 WV.

Change chassis mounted Fuse F3 to HP Part No. 2110-0002 FUSE: 2A, 250V.

Change chassis mounted Fuse F4 to HP Part No. 2110-0036 FUSE: 8A 125V.

Page 6-17, Table 6-1:

Add chassis mounted resistor R26 HP Part No. 0812-0019 R: FXD WW 0.33 OHM 5% 3W.

Add chassis mounted resistor R27 HP Part No. 0812-0020 R: FXD WW 0.39 OHM 5% 3W.

Add chassis mounted resistor R27 HP Part No. 0812-0020 R: FXD WW 0.39 OHM 5% 3W.

Page 7-3/7-4, Figure 7-2:

Change A10Q3 and A10Q4 to HP Part No. 1853-0020 (Recommended replacement for 1850-0062).

Change value of resistors A10R17/A10R18 to 17.8K ohms.

Page 7-5, Figure 7-3:

Add diode A3CR56. (Connect anode to source of A3Q2A and cathode to emitter of A3Q3.)

Add diode A3CR57. (Connect anode to source of A3Q2B and cathode to emitter of A3Q4.)

Add diode A3CR58. (Connect anode to base of A3Q5 and cathode to emitter of A3Q5.)

Change the A3 column of REFERENCE DESIGNATIONS Table to include diodes A3CR56, A3CR57 and A3CR58.

Substitute the attached Component Identification Assembly A3 board photo (Figure 5) for the photo shown in the manual.

CHANGE 1 (cont'd)

Pages 7-9/7-10, Figure 7-5:

Substitute the attached A8 Assy board photo (Figure 3) for the photo shown in the manual.

Add 78.7V breakdown diode A4CR11. (Connect anode to ground and cathode to A4R34, A4C8 junction.)

Change the A4 column of REFERENCE DESIGNATIONS Table to include diode A4CR11.

Pages 7-11/7-12, Figure 7-6:

Change Transistors A11Q2, A11Q3, A11Q4, A11Q6, A11Q7, A11Q8 and A11Q11 to HP Part Number 1853-0020. (Recommended replacement for 1850-0062).

Add diode A11CR19. (Connect anode to base of A11Q11 and cathode to emitter of A11Q11.)

Add chassis mounted diode CR6. (Connect anode to center conductor of MARKER output jack and cathode to ground.)

Add chassis mounted diode CR7. (Connect anode to center conductor of BLANKING output jack and cathode to ground.)

Change A11 column of REFERENCE DESIGNATIONS Table to include diode A11CR19.

Change chassis mounted component column (no heading) of REFERENCE DESIGNATIONS Table to include diodes CR6 and CR7.

Page 7-14:

Substitute the attached A8 Assy, Component Identification board photo (Figure 1) for the photo shown in the 8690B Manual.

CHANGE 2

Pages 6-14 and 6-15, Table 6-1:

Change A14 Heater Supply Assy to HP Part Number 08690-60054 (New board).

Add the following A14 Assy Components (Parts list for new A14 Assy).

C1	0160-3534	C: FXD MICA 510 PF 5% 100 VDCW.
C3	0180-0089	C: FXD ELECT 10 UF -10% +100% 150 VDCW.
C4	0160-3539	C: FXD MICA 820 PF 5% 100 VDCW.
C5	0180-0141	C: FXD ELECT 50 UF +75 -10% 50 VDCW.
C6	0160-2205	C: FXD MICA 120 PF 5%.
C7	0180-0094	C: FXD ELECT 100 UF 25 VDCW.
CR1	1902-0041	DIODE, BREAKDOWN: 5.11V 5% 400 mW.
CR2	1901-0025	DIODE, SILICON 100 MA/1V.
CR3	1901-0025	DIODE, SILICON 100 MA/1V.
CR4	1901-0025	DIODE: SILICON 100 mA/1V.
IC1	1820-0196	IC: VOLTAGE REGULATOR.
IC2	1820-0196	IC: VOLTAGE REGULATOR.
IC3	1820-0196	IC: VOLTAGE REGULATOR.
Q1	1854-0062	TRANSISTOR: SILICON NPN.
R1	0757-0418	R: FXD MET FLM 619 OHM 1% 1/8W.
R2	0757-0440	R: FXD MET FLM 7.5K OHM 1% 1/8W.
R3	0757-0438	R: FXD MET FLM 5.11K OHM 1% 1/8W.
R4	0757-0461	R: FXD MET FLM 68.1K OHM 1% 1/8W.
R5	0757-0473	R: FXD MET FLM 221K OHM 1% 1/8W.
R6	0757-0401	R: FXD MET FLM 100 OHM 1% 1/8W.
R7	0757-0416	R: FXD MET FLM 511 OHM 1% 1/8W.
R8	0698-3156	R: FXD MET FLM 14.7K OHM 1% 1/8W.
R9	0757-0447	R: FXD MET FLM 16.2K OHM 1% 1/8W.
R10	2100-1759	R: VAR WW 2K OHM 10% LIN 1/2W.
R11	0757-0441	R: FXD MET FLM 8.25K OHM 1% 1/8W.
R12	0757-0199	R: FXD MET FLM 21.5K OHM 1% 1/8W.
R13	0698-3154	R: FXD MET FLM 4.22K OHM 1% 1/8W.
R14	0757-0416	R: FXD MET FLM 511 OHM 1% 1/8W.
R15	0757-0280	R: FXD MET FLM 1.0K OHM 1% 1/8W.
R16	0757-0289	R: FXD MET FLM 13.3K OHM 1% 1/8W.
R17	0698-3152	R: FXD MET FLM 3.48K OHM 1% 1/8W.

CHANGE 2 (cont'd)

R18 2100-1758 R: VAR WW 1K OHM 10% LIN 1/2W.
 R19 0757-0440 R: FXD MET FLM 7.5K OHM 1% 1/8W.

Page 7-14/7-15, Component Identification photo and Figure 7-8:

Substitute the attached A14 Assy board photo and schematic (Figures 2 and 3) for those shown in the 8690B Manual.

CHANGE 3

Page 6-8, Table 6-1:

Add 9 pin tube socket for A5V1 (HP Part No. 1200-0062).

Page 6-10, Table 6-1:

Change capacitor A8C6 to HP Part No. 0180-2268 C: F 140 UF 30 WVDC.
 Change resistor A8R13 to HP Part No. 0757-0868 R: F 562K OHM 1% 1/2W.
 Change resistor A8R16 to HP Part No. 0757-0422 R: F 909 OHM 1% 1/8W.

Page 6-12, Table 6-1:

Add 7 pin tube socket for A10 V1 (HP Part No. 1200-0053).

CHANGE 4

Page 6-18, Table 6-1, under MISCELLANEOUS:

Add the following note to define the 8690B color scheme.

NOTE

This change implements a different color scheme for the standard instrument. Colors prior to this change are now available as options. Refer to listing below.

8690B STANDARD. Indicates color scheme for the 8690B beginning with this change. (Includes MINT GRAY front panel and OLIVE GRAY cabinet.)

8690B Option A85. Indicates combination color scheme for the 8690B. (Includes LIGHT GRAY front panel and OLIVE GRAY cabinet.)

8690B Option X95. Indicates color scheme for the 8690B prior to this change. (Includes LIGHT GRAY front panel and BLUE GRAY cabinet.)

Add the following 8690B parts or description changes.

08690-4105 CORNER GLIDE (LIGHT GRAY)
 # 08690-40002 CORNER GLIDE (MINT GRAY) (STANDARD COLOR)
 08690-6041 ASSY: FRONT PANEL (LIGHT GRAY)
 # 08690-60055 ASSY: FRONT PANEL (MINT GRAY) (STANDARD COLOR)
 08690-6042 DRIVE ASSY: DIAL (LIGHT GRAY)
 # 08690-60056 DRIVE ASSY: DIAL (MINT GRAY) (STANDARD COLOR)

#Denotes standard color for 8690B part beginning with this change.

Page 6-19, Table 6-1, under MISCELLANEOUS:

Add the following 8690B parts or description changes.

08690-0016 TOP COVER ASSY (BLUE GRAY)
 #08690-00033 TOP COVER ASSY (OLIVE GRAY) (STANDARD COLOR)
 08690-00031 REAR PANEL (LIGHT GRAY)
 # 08690-00035 REAR PANEL (MINT GRAY) (STANDARD COLOR)
 5000-0746 SIDE COVER 8 X 16 (BLUE GRAY)
 #5000-8725 SIDE COVER 8 X 16 (OLIVE GRAY) (STANDARD COLOR)

CHANGE 4 (cont'd)

08690-0017 BOTTOM COVER ASSY (BLUE GRAY)
 #08690-00034 BOTTOM COVER ASSY (OLIVE GRAY) (STANDARD COLOR)
 5060-0777 RACK MOUNT KIT 8H (LIGHT GRAY)
 #5060-8742 RACK MOUNT KIT 8H (MINT GRAY) (STANDARD COLOR)
 5060-0765 RETAINER HANDLE ASSY (BLUE GRAY)
 #5060-8735 RETAINER HANDLE ASSY (OLIVE GRAY) (STANDARD COLOR)

#Denotes standard color for 8690B part beginning with this change.

CHANGE 5

Page 6-4, Table 6-1:

Change transistor A3Q6 to HP Part No. 1854-0079, TRANSISTOR: SILICON NPN, 2N3439.

Page 6-6, Table 6-1:

Add diode A4CR12 1901-0033 DIODE: SILICON 100 mA 180 WV.

Page 6-9, Table 6-1:

Change transistors A6Q1/A6Q2 to HP Part No. 1854-0079, TRANSISTOR: SILICON NPN, 2N3439.

Page 6-12, Table 6-1:

Change resistors A10R17/A10R18 to HP Part No. 0698-3126; R: FXD 17.8K OHM 1% 1/8W. (Recommended replacement for 8690B instruments with serial prefixes 1114A and 1124A.)

Page 7-3, Figure 7-2:

Change value of resistors A10R17/A10R18 to 17.8K ohms.

Page 7-5, Figure 7-3:

Change transistor A3Q6 to HP Part No. 1854-0079.

Page 7-9, Figure 7-5:

Add diode A4CR12 in series with zener diode A4CR11. Connect cathode of A4CR12 to ground, and anode to A4CR11.

Page 7-17, Figure 7-9:

Change transistors A6Q1/A6Q2 to HP Part No. 1854-0079.

CHANGE 6

Page 6-7, Table 6-1:

Change A5Q2 to HP Part No. 1854-0475.

Page 6-14, Table 6-1:

Change A12Q4 to HP Part No. 1854-0475.

Page 7-13, Figure 7-7:

Change A12Q4A and A12Q4B to HP Part No. 1854-0475.

Page 7-17, Figure 7-9:

Change A5Q2 to HP Part No. 1854-0475.

CHANGE 7

Page 6-18, Table 6-1:

Add HP Part No. 3160-0092 GUARD: FAN BLADE.

CHANGE 8

Page 6-10, Table 6-1:

Change A8R14 to HP Part No. 0698-3402, R: FXD MET FLM 316 OHM 1% 1/2W.

CHANGE 9

Page 6-10, Table 6-1:

Change A8C4 and A8C5 to HP Part No. 0160-4051 C: FXD .01 UF 4 kV.

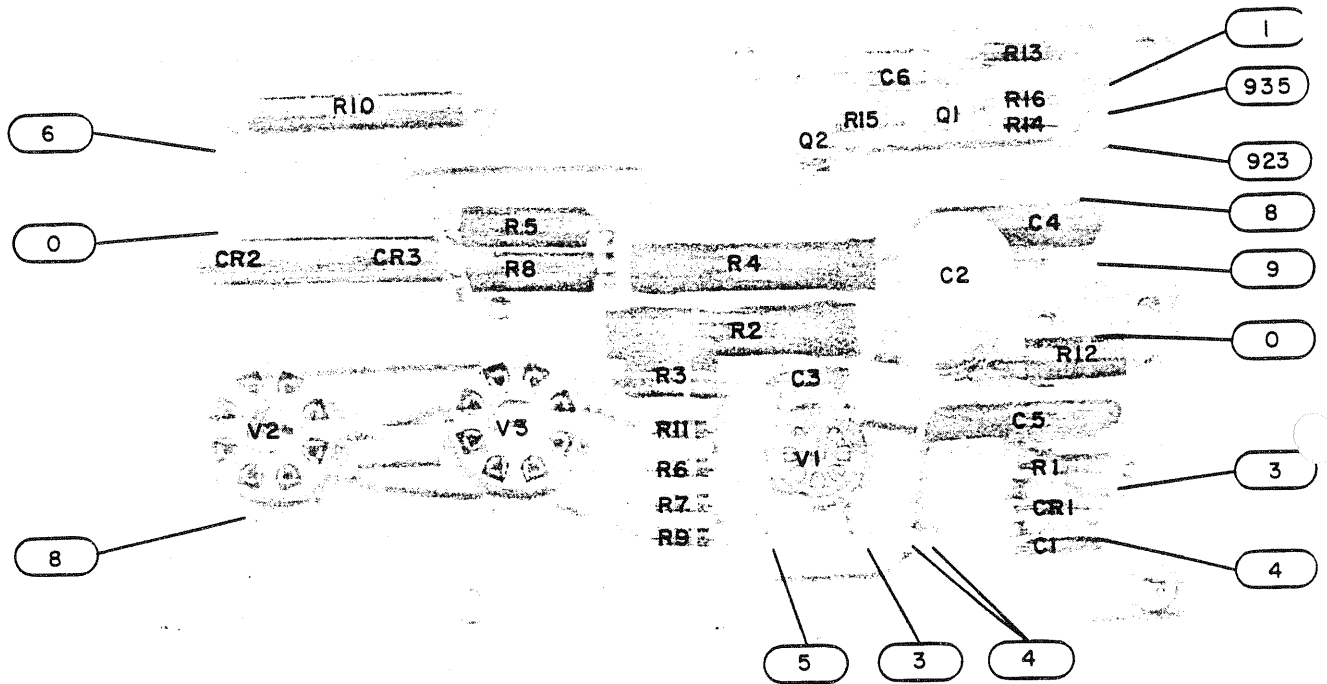

Figure 1. Component Identification, Assembly A8 (Part of Change 1)

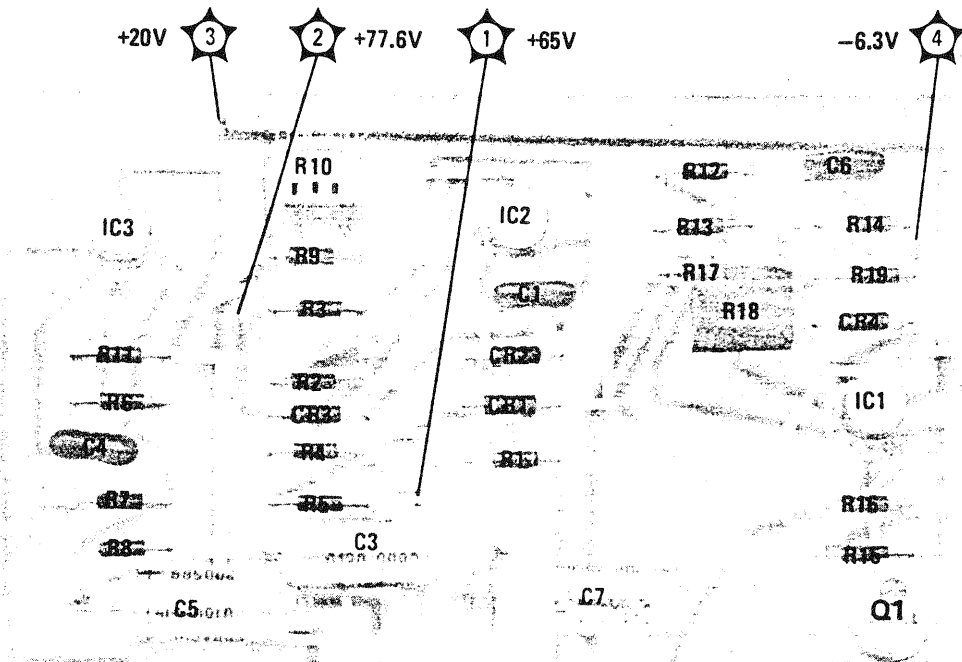

Figure 2. Component Identification, Assembly A14 (Part of Change 2)

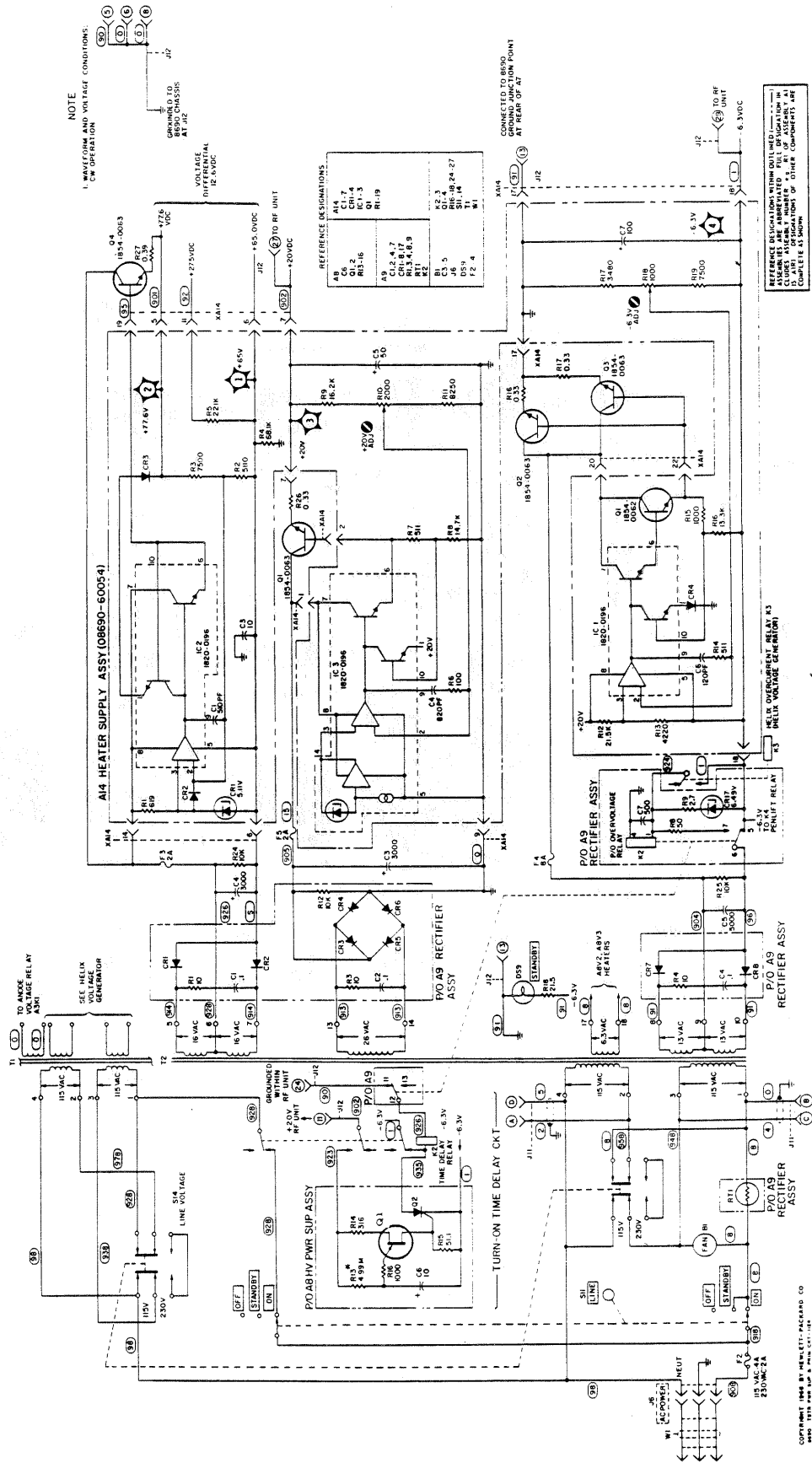

Figure 3. Power Supply Section, +20V, +12.6V and -6.3V Power Supplies (Part of Change 2)

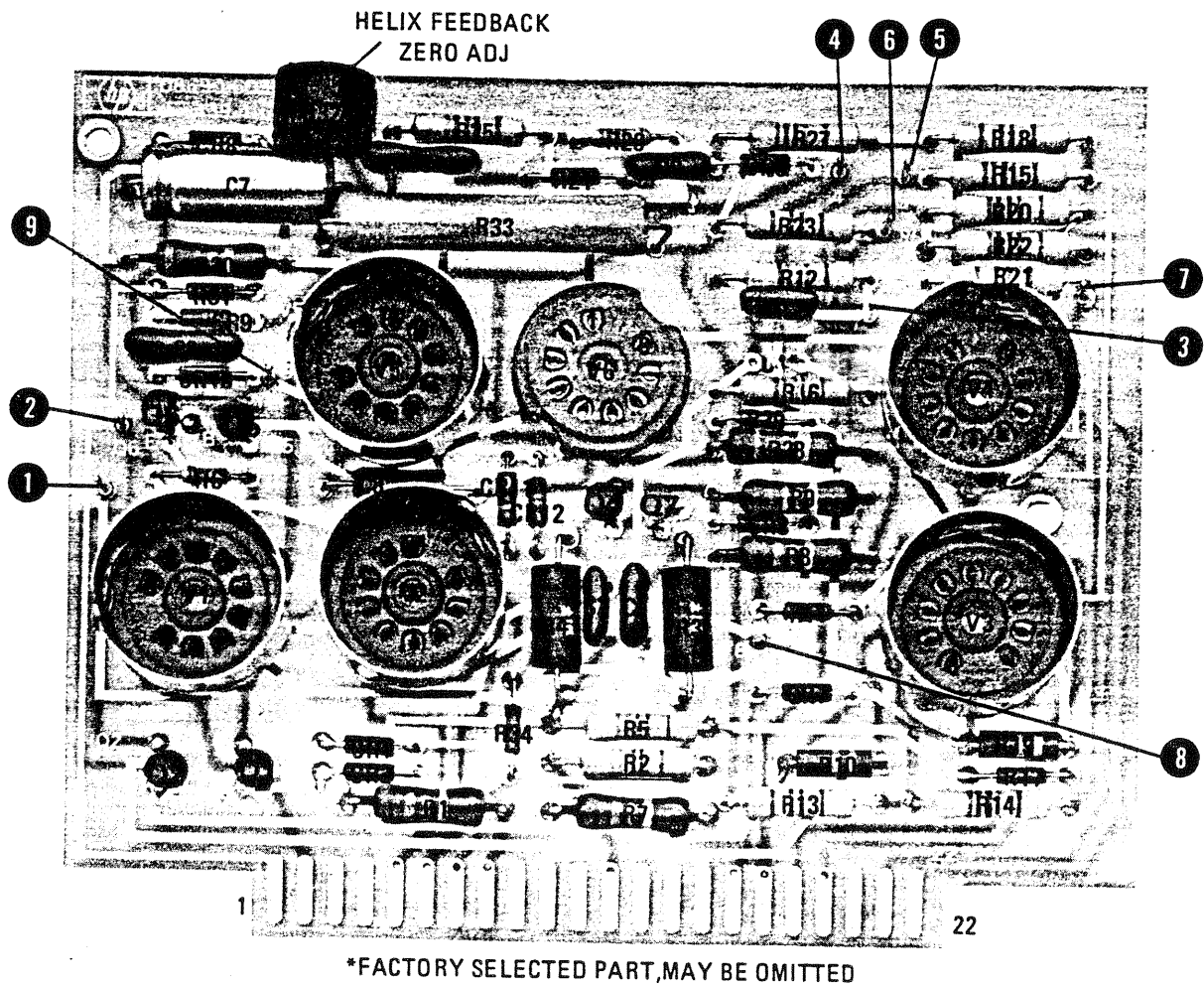

Figure 4. Component Identification, Assembly A4 (Part of Change 5)

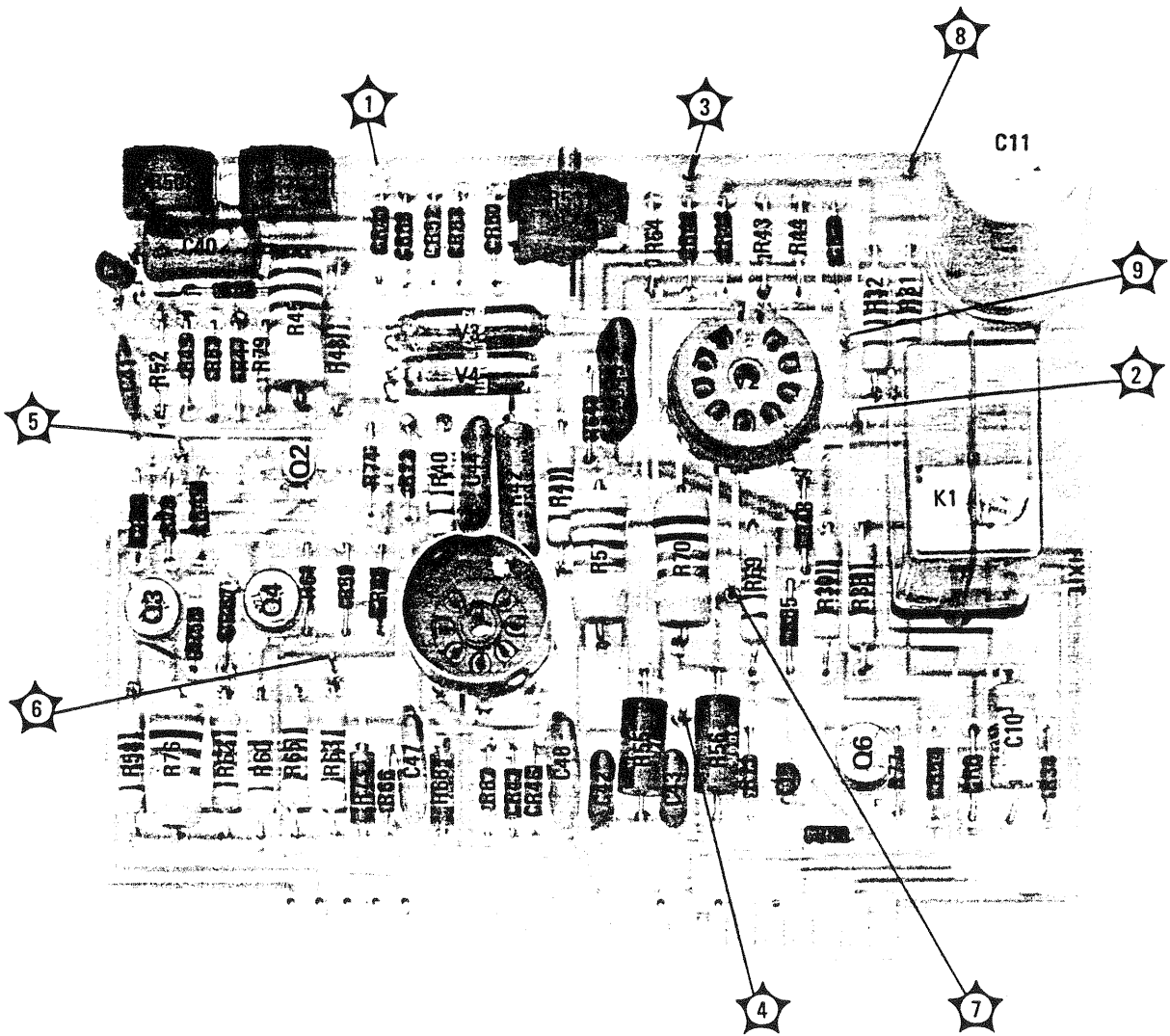

Figure 5. Component Identification, Assembly A3 (Part of Change 1)

CHANGE 10

Page 6-4, Table 6-1:

Change A3R34 to HP Part No. 0698-3431 R:FXD MET FLM 23.7 OHM 1% 1/8W.

Page 6-17, Table 6-1:

Change R18 to HP Part No. 0698-3431 R:FXD MET FLM 23.7 OHM 1% 1/8W.

Page 7-5, Figure 7-3 (Schematic Diagram):

Change A3R34 to 23.7 Ohm.

Page 7-15, Figure 7-8 (Schematic Diagram):

Change R18 to 23.7 Ohm.

CHANGE 11

Page 6-17, Table 6-1:

Add S15 3103-0041 SWITCH:THERMAL.

Page 7-15, Figure 7-8:

Add thermal switch S15 to schematic diagram of Power Supply Section as shown in Figure 6.

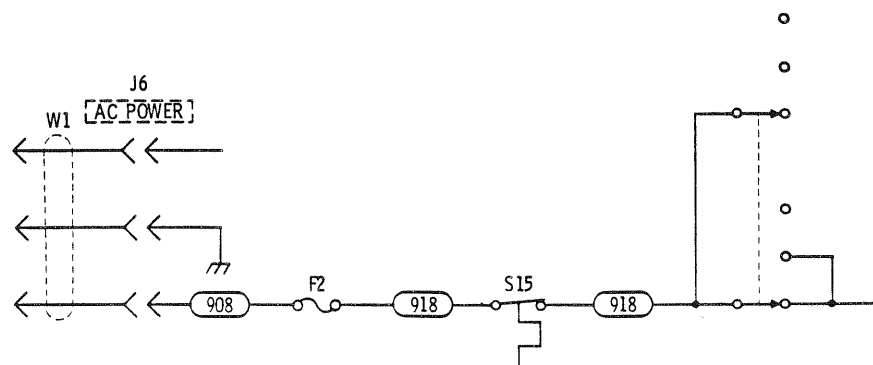

Figure 6. Partial Schematic Diagram of the Power Supply Section Showing Thermal Switch S15
(Part of Change 11)

CHANGE 12

Page 6-9, Table 6-1:

Change A6R3, A6R9, A6R11 and A6R12 to HP Part No. 0698-3442, R:FXD MET FLM 237 OHM 1% 1/8W.

Page 7-17, Figure 7-9:

Change A6R3, A6R9, A6R11, and A6R12 to 237 OHMS.

CHANGE 13

Page 6-14, Table 6-1:

Change A12 BOARD ASSY: ALC AMPLIFIER to HP Part No. 08690-60074.

Change A12XV1 SOCKET:TUBE to HP Part No. 1200-0573.

CHANGE 14

Page 6-5, Table 6-1:

Change A4 HP Part Number to 08690-60076.

Add second A4 entry HP Part Number 08690-60077 BD ASSY: HELIX AMPL (H26).

CHANGE 15

Page 6-10, Table 6-1:

Change A8 HP Part Number to 08690-60075.

CHANGE 16

Page 6-17, Table 6-1:

Change XF1 and XF2 parts identification to read as follows:

Reference Designation	HP Part No.	Description
XF1, XF2	2110-0470	FUSEHOLDER-EXTR POST 20A 200V UL/IEC
	2110-0465	FUSEHOLDER-CAP UL/IEC .25X1 .25 FUSE
	2110-0467	NUT, HEX SINGLE CHAMFER 1/2-28 THREAD
	2190-0037	WASHER-LK INTL T NO. 1/2 .512 IN ID .789
	1400-0090	WASHER: RUBBER 5/8" OD

CHANGE 17

Page 6-3, Table 6-1:

Change A2R32 to HP Part No. 0698-3424 R:FXD 237K 1% .5W FACTORY SELECTED PART.

Page 6-10, Table 6-1:

Change A10C2 to HP Part No. 0160-2225 C:FXD MICA 2000PF 5% 300VDCW FACTORY SELECTED PART.

Change A10R3 to HP Part No. 0698-8878 R:FXD 2.74MEGOHM 1% 1/4W.

Page 6-16, Table 6-1:

Delete CR6 and CR7.

Page 6-17, Table 6-1:

Add VR1 and VR2 HP Part No. 1902-0551 DIODE: BREAKDOWN 6.19V 5%.

Page 7-3, Figure 7-2:

Change nominal value of A10C2 to 2000 pF.

Change value of A10R3 to 2.74 megohms.

Page 7-11, Figure 7-6:

Change CR6 and CR7 (added in CHANGE 1) to VR1 and VR2 respectively (6.19 volts Zener diodes).

CHANGE 18

Page 6-10, Table 6-1:

Add F1 HP Part No. 2110-0011 FUSE .062A 250V.

Add XF1 HP Part No. 2110-0269 FUSEHOLDER-CLIP TYPE.

Page 7-9, Figure 7-5:

Change A8 HV Power Supply circuitry as shown in attached partial schematic.

Add NOTE 3 to schematic diagram notes as follows:

If fuse A8F1 blows, check RF Unit for shorted capacitor A1C2 and for excessive helix current. See RF Unit Operating and Service Manual adjustment section for checking helix current. RF Unit Operating and Service Manual HP Part Numbers are as follows:

8691A-94A: 08691-90021

8691B-95B: 08691-90022

8695A-97A: 08695-90015

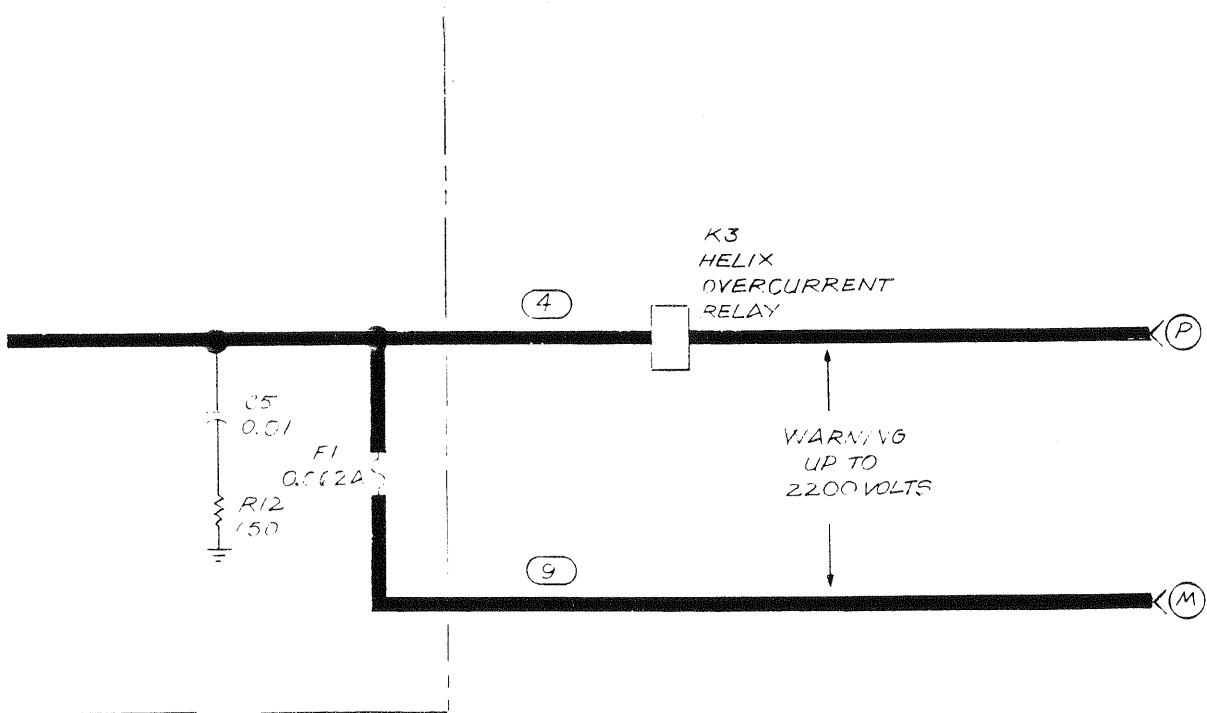

P/O Figure 7-5. Frequency Control Section

► **CHANGE 19**

Page 6-10, Table 6-1:

Add A8F2, Part No. 2110-0036, FUSE 8A 125V FAST BLOW CARTRIDGE TYPE.

Add A8XF2, Part No. 2110-0269, FUSE HOLDER CLIP TYPE.

Page 6-25, Table 6-2:

Add Part No. 2110-0036, FUSE: 8A 125V FAST BLOW, Mfr. 75915, 312008.

Add Part No. 2110-0269, FUSE HOLDER, Mfr. 28480, 2110-0269.

Page 7-9, Figure 7-5:

Change 6.3V input to filaments of A8V2 and A8V3 (P/O A8 HV Power Supply) as shown in partial schematic below:

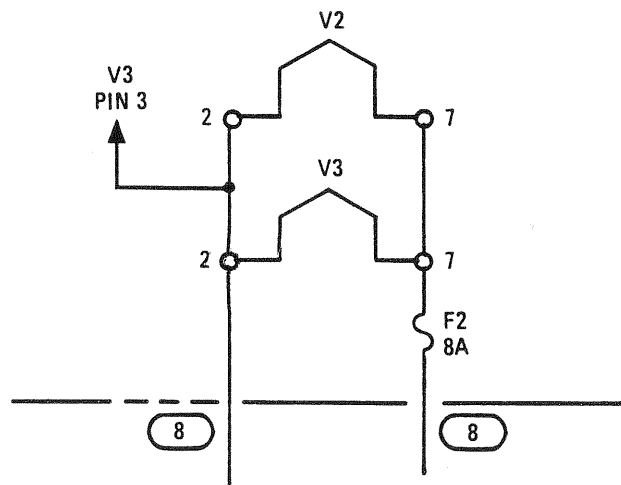

Figure 7-5. A8 HV Power Supply Partial Schematic (CHANGE 19)

HP MANUAL CHANGES

MANUAL TITLE: 8690B
 MANUAL PRINTED: May, 1972.
 MANUAL PART NO: 08690-90018
 CHANGE DATE: 11th Dec. 74

Make all corrections in your manual according to errata.
 Check the following table for your instrument serial prefix
 and make indicated changes in the manual:

SERIAL PREFIX	MAKE CHANGE	SERIAL PREFIX	MAKE CHANGE	SERIAL PREFIX	MAKE CHANGE
1218U-00924	ERRATA	1250u-01059	1 - 4		
1218U-00939	1	1250U-01149	1 - 5		
1250U-00959	1,2,	1250U-01169	1 - 6		
1250U-00999	1,2,3,				

- ERRATA Table 6-1, Page 6-2
 Change: A2C3* to Part No 0160-2675 C:FXD 3900pF 1% 300VDC
 Table 6-1, Page 6-11
 Id: A9MP1,MP2 Part No 1205-0011 Heat Sink
 Table 6-1, Page 6-16
 Id: F2 Part No 2110-0055 Fuse 4A 250V
 Page 7-14, 7-16. Component Identification, Assembly A9
 On the left side of photo three places have wire colour code 913 Change the center of to 6.
 Page 7-15, Figure 7-8
 On T1 26 VAC winding pin 13 change wire colour code from 913 to 6.
 Page 5-17, Table 5-4, Power Supply Adjustment
 Change: The Power supply adjustment sequence as indicated below:
- | | |
|-------------------------|-------------------------|
| Old Adjustment Sequence | New Adjustment Sequence |
| a,b,c,d,e,f,g,h,i | a,b,c,f,g,h,i,d,e |
- Table 6-1, Page 6-8
 Change: A5R6 to Part No 0757-0459 R:FXD 56.2K OHM 1% $\frac{1}{2}$ W
 A5V2 to Part No 1940-0012 Electron Tube 81V
 Table 6-1, Page 6-4
 Change: A3R55,56 to Part No 0698-7829 R:FXD 500K 1% $\frac{1}{2}$ W
 Page 6-4, Table 6-1
 Change: A3Q6 to Part No 1854-0079 XSTR NPN 2N3439
 Page 6-6, Table 6-1
 Id: A4CR12 1901-0033 DI: SI 100mA 180WV
 Page 6-9, Table 6-1
 Change: A10R17/R18 to Part No 0698-3126 R:FXD 17.8K OHM 1% $\frac{1}{2}$ W
 Page 7-3, Figure 7-2
 Change: Value of resistors A10R17/R18 to 17.8K OHM
 Page 7-5, Figure 7-3
 Change: A3Q6 to Part No 1854-0079
 Page 7-9, Figure 7-5
 Id: Diode A4CR12 in series with zener diode A4CR11. Connect cathode of A4CR12 to ground, anode to A4CR11
 Page 7-17, Figure 7-9
 Change: A6Q1/Q2 to Part No 1854-0079
 Page 6-16, Table 6-1
 Change: F1 to Part No 2110-0420 FUSE .032A 250V
 Page 7-5, Figure 7-3
 Change: F1 to .032A
 Page 6-10, Table 6-1
 Change: A8C6 to Part No 0180-2268 C:FXD 140UF 30WVDC
 A8R13 to Part No 0757-0868 R:FXD 562K OHM 1% $\frac{1}{2}$ W
 A8R16 to Part No 0757-0422 R:FXD 909K OHM $1\frac{1}{2}$ W

Errata (cont'd)

- Page 6-4, Table 6-1

Add: A3CR56, A3CR57 and A3CR58 Part No 1901-0033 DI:SI 100mA 180WV

Page 6-6, Table 6-1

Add: A4CR11 Part No 1902-3400 DI:SI 78.7V 2% 400mW

Change: A1OR17/R18 to Part No 0698-3136 R:FXD 17.8K 1% $\frac{1}{2}$ W

Page 6-10, Table 6-1

Change: A8 Assy to Part No 08690-60053

Add: A8Q2 Part No 1884-0073 THYRISTOR, SCR

A8R15 Part No 0757-1000 R:FXD 51.1 OHM 1% $\frac{1}{2}$ W

A8R16 Part No 0757-0280 R:FXD 1.0K OHM 1% $\frac{1}{2}$ W

Change: A8C6 to Part No 0180-0183 C:FXD 10UF +75-10% 50VDCW

A8Q1 to Part No 1855-0010 UNIJUNCTION: SI

A8R13 to Part No 0698-4348 R:FXD 4.99M OHM 1% $\frac{1}{2}$ W

A8R14 to Part No 0698-3444 R:FXD 316 OHM 1% $\frac{1}{2}$ W

Page 6-11, Table 6-1

Change: A1OQ3 and A1OQ4 to Part No 1853-0020 XSTR SI PNP (Recommended replacement for 1850-00 Pages 6-12, and 6-13; Table 6-1

Add: A11CR19 Part No 1901-0033 DI:SI 100mA 180WV

Change: A11Q2, A11Q3, A11Q4, A11Q6, A11Q7, A11Q8 and A11Q11 to Part No 1853-0020 XSTR SI PNP (Recommended replacement for 1850-0062)

Page 6-16, Table 6-1

Add: Chassis mounted diodes CR6 and CR7 Part No 1901-0033 DI:SI 100mA 180WV

Change: Chassis mounted Fuse F3 to Part No 2110-0002 FUSE: 2A, 250V

Chassis mounted Fuse F4 to Part No 2110-0036 FUSE 8A 125V

Page 6-17, Table 6-1

Add: Chassis mounted resistor R26 Part No 0812-0019 R:FXD WW 0.33 OHM 5% 3W

Chassis mounted resistor R27 Part No 0812-0020 R:FXD WW 0.39 OHM 5% 3W

Page 7-3/7-4, Figure 7-2

Change: A1OQ3 and A1OQ4 to Part No 1853-0020 (Recommended Replacement for 1850-0062)

Value of resistors A1OR17/A1OR18 to 17.8K OHM

Page 7-5, Figure 7-3

Add: Diode A3CR56. (Connect anode to source of A2Q2A and cathode to emitter of A3Q3)

Diode A3CR57. (Connect anode to source of A3Q2B and cathode to emitter of A3Q4)

Diode A3CR58. (Connect anode to base of A3Q5 and cathode to emitter of A3Q5)

Change: A3 column of REFERENCE DESIGNATIONS Table to include diodes A3CR56, A3CR57 and A3CR58

Substitute the attached Component Identification Assembly A3 board photo (Figure 5) for the photo shown in the manual.

Table 6-1, Page 6-17

Change: W1 to Part No 8120-1351 Cbl Assy Power Cord
- CHANGE 1

Table 6-1

Change: B1 to part no 3160-0056 Fan Tube Axial
- CHANGE 2

All 10% carbon composition resistors are replaced with 5%
Number sequence is changed :

0684-XXX1	to	0683-XXX5
0687-XXX1	to	0696-XXX5
- CHANGE 3

Table 6-1

Change : C2,3 to part no 0160-0669 C. Fxd 2uF 2KV
- CHANGE 4

Table 6-1

Change : A8R14 to part no 0698-3402 R. Fxd 316ohm 1% $\frac{1}{2}$ wt

CHANGE 5

Page 6-2, Table 6-1

Change : A2R8 to hp part no. 2100-0672 R: VAR 2K Ohm 20% LIN $\frac{1}{2}$ W
A2R19 to hp part no. 2100-0674 R: VAR 20K Ohm 20% LIN $\frac{1}{2}$ W
A2R22 to hp part no. 2100-0673 R: VAR 5K Ohm 20% LIN $\frac{1}{2}$ W
A2R23 to hp part no. 2100-0673 R: VAR 5K Ohm 20% LIN $\frac{1}{2}$ W
A2R24 to hp part no. 2100-0673 R: VAR 5K Ohm 20% LIN $\frac{1}{2}$ W
A2R25 to hp part no. 2100-0672 R: VAR 2K Ohm 20% LIN $\frac{1}{2}$ W
A2R28 to hp part no. 2100-0676 R: VAR 50K Ohm 20% LIN $\frac{1}{2}$ W

Page 6-3, Table 6-1

Change : A2R30 to hp part no. 2100-0673 R: VAR 5K Ohm 20% LIN $\frac{1}{2}$ W
A2R31 to hp part no. 2100-0673 R: VAR 5K Ohm 20% LIN $\frac{1}{2}$ W

Page 6-4, Table 6-1

Change : A3R53 to hp part no. 2100-0674 R: VAR 20K Ohm 20% $\frac{1}{2}$ W

Page 6-13, Table 6-1

Change : A11R2 to hp part no. 2100-0675 R: VAR 25K Ohm 20% LIN $\frac{1}{2}$ W
A11R18 to hp part no. 2100-0675 R: VAR 25K Ohm 20% LIN $\frac{1}{2}$ W

CHANGE 6

Page 6-17, Table 6-1

Change : R18 to part no. 0698-3431 R. FxD 23.7 Ω 1% $\frac{1}{2}$ w.

Page 6-4, Table 6-1

Change : A3R34 to part no. 0688-3431 R FxD 23.7 Ω 1% $\frac{1}{2}$ w.

TABLE OF CONTENTS

Section	Page	Section	Page
I GENERAL INFORMATION	1-1	III OPERATION (Cont.)	
1-1. Description	1-1	3-125. Leveling at the RF Output	3-17
1-12. Instruments Covered by Manual	1-1	3-127. Standard Sweep Oscillator Using Crystal Detector	3-17
II INSTALLATION	2-1	3-130. Option 001 RF Units	3-18
2-1. Incoming Inspection	2-1	3-137. Displaying Swept-Frequency Measurements	3-18
2-3. Preparation for Use	2-1	3-138. Oscilloscope Display	3-18
2-4. Power Requirements	2-1	3-143. X-Y Recorder Display	3-18
2-6. 115/230 Volt Operation	2-1	3-146. Recorder Calibration	3-18
2-9. Power Cable	2-1	IV PRINCIPLES OF OPERATION	4-1
2-12. Cooling	2-1	4-1. Introduction	4-1
2-14. Air Filter	2-1	4-4. The Backward-Wave Oscillator Tube	4-1
2-16. Magnetic Interference	2-1	4-11. The Frequency Control Section	4-4
2-18. Bench Use	2-1	4-16. The Ramp Generator	4-4
2-21. Rack Mounting	2-1	4-34. The Reciprocal Amplifier	4-8
2-23. Repackaging for Shipment	2-2	4-41. The Unity Gain Followers	4-10
III OPERATION	3-1	4-43. The Ramp Combining Circuit	4-10
3-1. Introduction	3-1	4-50. The Helix Voltage Generator	4-12
3-14. General Operating Information	3-1	4-57. The Anode Supply Circuit	4-12
3-15. RF Output Connector	3-1	4-60. The BWO Grid Modulator	4-14
3-17. Output Power Range	3-2	4-63. The Amplitude Modulation Section	4-14
3-19. RF Input Limitation	3-2	4-65. The Blanking Switch	4-14
3-21. BWO Life	3-2	4-68. The Square-Wave Generator	4-14
3-24. Magnetic Interference	3-2	4-72. The Frequency Marker Section	4-14
3-26. Controls, Connectors and Indicators	3-2	4-83. The Automatic Level Control Amplifier	4-15
3-28. Basic Operating Procedures	3-2	4-91. The Attenuator-Modulator	4-16
3-29. Turn-On	3-2	4-95. Optional Directional Detector	4-16
3-30. Standby Operation	3-5	4-97. Low-Pass Filter	4-17
3-33. Sweep Functions	3-5	4-99. The Primary Power Turn-On Sequence	4-17
3-35. Start-Stop Sweep	3-5	4-102. The Power Supplies	4-17
3-37. ΔF Sweep	3-5	4-103. General Operating Principles +275 and -300V Power Supply Turn-On Sequence	4-17
3-39. Marker Sweep	3-5	4-116. +275 and -300V Power Supply Interdependence	4-19
3-41. EXT FM	3-5	4-120. +275V and -300V Current Limiters	4-19
3-46. Sweep Modes	3-5	4-124. +275 and -300V Voltage Limiters	4-21
3-48. Auto	3-10	4-128. The -6.3 Volt Supply	4-21
3-52. Triggered	3-10	4-132. The 12.6 Volt Supply	4-21
3-57. CW	3-10	4-134. The +20 Volt Supply	4-21
3-60. Manual	3-11	4-136. BWO Tube Helix Over-Current Protection	4-22
3-64. Sweep Time Control	3-11	V MAINTENANCE	5-1
3-67. Sweep Output	3-11	5-1. Introduction	5-1
3-69. Sweep Reference Output	3-11	5-4. Maintenance Precautions	5-1
3-71. Penlift	3-11	5-5. Periodic Maintenance	5-1
3-73. RF Blanking	3-11	5-6. Cleaning the Air Filter	5-1
3-76. Expanded Sweep Operation	3-12	5-8. Lubrication	5-1
3-80. Four Preset CW Frequencies	3-12	5-14. Performance Tests	5-1
3-82. Amplitude Modulation	3-12	5-16. Adjustments	5-16
3-83. External AM	3-12		
3-85. Internal Frequency Markers	3-12		
3-88. Internal Square Wave	3-12		
3-90. RF Power Leveling	3-12		
3-96. Leveling Point Considerations	3-13		
3-101. Dependency of Maximum Leveled Power on Frequency	3-14		
3-103. Leveling Equipment	3-14		
3-112. Leveling Performance	3-15		
3-117. Leveling Controls, Indicators and Inputs	3-16		

TABLE OF CONTENTS (cont'd)

Section	Page	Section	Page
V MAINTENANCE (Cont.)		VI REPLACEABLE PARTS6-1
5-22. Power Supply Adjustments	5-16	6-1. Introduction6-1
5-25. Isolating Trouble in Transistor Circuits.	5-31	6-3. Ordering Information6-1
5-30. Tube, Semiconductor Replacement	5-31	VII SCHEMATIC DIAGRAMS7-1
5-32. Etched Circuits	5-31	7-1. Introduction7-1
5-39. A12Q1 Lead Identification	5-36	APPENDIX I	
5-41. Troubleshooting.	5-36	Manual ChangesI-1

LIST OF ILLUSTRATIONS

Number	Title	Page	Number	Title	Page
1-1.	Model 8690B with RF Unit Installed	1-0	4-10.	Ramp Combining Circuit Simplified Diagram	4-12
2-1.	Preparation for Rack Mounting	2-2	4-11.	Helix Voltage Generator Block Diagram	4-13
3-1.	Front Panel Controls, Connectors, And Indicators	3-2	4-12.	Marker Generator Simplified Sche- matic Diagram	4-15
3-2.	Rear Panel Controls and Connectors.	3-4	4-13.	Turn-On Sequence Diagram	4-18
3-3.	Start-Stop Sweep Operation.	3-6	4-14.	Regulated Power Supply Block Diagram	4-19
3-4.	ΔF Sweep Operation	3-7	4-15.	Sequence Diagram for BWO Tube Heater Over-Voltage and Helix Over- Current Protection	4-20
3-5.	Marker Sweep Operation	3-8	5-1.	Maintenance Equipment Setup Number 1	5-12
3-6.	External FM Operation	3-9	5-2.	Maintenance Equipment Setup Number 2	5-13
3-7.	External FM Limitations	3-10	5-3.	Maintenance Equipment Setup Number 3	5-14
3-8.	Typical RF Power Output Charac- teristics of 1-2 GHz and 12.4-18 GHz BWO Tubes	3-13	5-4.	Pin Locations on Connector J11	5-16
3-9.	Typical Leveling Loop	3-13	5-5.	Pin Locations on Connector J12	5-16
3-10.	Effect of Leveling Point on Power Variation	3-14	5-6.	Component Identification, Left and Right Side	5-24
3-11.	Comparison of Maximum Leveled RF Power and Frequency Range Swept	3-15	5-7.	Component Identification, Interior Top View	5-25
3-12.	Coaxial Leveling Loop Using Crystal Detector.	3-17	5-8.	Internal Adjustment Identification, Top View	5-26
3-13.	Waveguide Leveling Loop Using Crystal Detector	3-17	5-9.	Component Identification, Interior Bottom View	5-27
3-14.	Coupler-Compensated Waveguide Leveling Loop Using Crystal Detector	3-18	5-10.	Internal Adjustment Identification, Bottom View	5-28
3-15.	Example Oscilloscope Displays of Correct and Incorrect EXT ALC GAIN Adjustment	3-18	5-11.	Component and Terminal Identification, Interconnection Assembly A7	5-29
3-16.	Typical X-Y Recorder Setup to Plot Sweep Oscillator Power Output Characteristic	3-19	5-12.	Transistor Biasing and Operating Characteristics	5-32
4-1.	Simplified Block Diagram	4-2	5-13.	Flow Diagram Symbols and Definitions	5-36
4-2.	Block Diagram Showing Section Constituents	4-3	5-14.	Troubleshooting Flow Index	5-38
4-3.	The Backward-Wave Oscillator Tube	4-4	5-15.	Detailed Troubleshooting Flow	5-46
4-4.	Tuning Voltage Generator Block Diagram	4-5	5-16.	+275V and -300V Power Supply Troubleshooting Flow	5-61
4-5.	Simplified Schematic Diagram of Ramp Generator in Trigger Mode	4-6	7-1.	Schematic Diagram Notes	7-1
4-6.	Simplified Schematic Diagram of Ramp Generator in Auto Mode	4-7	7-2.	Frequency Control Section: Tuning Voltage Generator with Blanking Pen Lift Circuits.	7-3 7-4
4-7.	Simplified Diagram of Blanking and Penlift Circuits.	4-9	7-3.	Frequency Control Section: Recipro- cal Amplifier	7-5 7-6
4-8.	Reciprocal Amplifier Functional Schematic Diagram	4-10	7-4.	Frequency Control Section: Tuning Voltage and Marker Combining (Summing) Circuits	7-7 7-8
4-9.	Simplified Schematic Diagram of Functional Switching	4-11			

LIST OF ILLUSTRATIONS (Cont'd)

Number	Title	Page	Number	Title	Page
7-5.	Frequency Control Section: Helix Voltage Generator	7-9/7-10	7-8.	Power Supply Section: 12.6, +20, and -6.3 Volt Power Supplies and Primary Power Circuit . . .	7-15/7-16
7-6.	Amplitude Modulation Section . . .	7-11/7-12	7-9.	Power Supply Section: +275, -83 and -300 Volt Power Supplies . . .	7-17/7-18
7-7.	Automatic Level Control (ALC) Amplifier	7-13/7-14			

LIST OF TABLES

Number	Title	Page	Number	Title	Page
1-1.	Summary of Specifications	1-1	5-4.	Adjustments	5-17
1-2.	Specifications of 8690B Sweep Oscillator with RF Unit Installed	1-2	5-5.	J11 /J12 Connections to RF Unit . . .	5-22
3-1.	Leveling Performance of Coaxial Leveling Loops.	3-16	5-6.	Interconnection Assembly A7 Wire Connections Colors	5-30
3-2.	Leveling Performance of Waveguide Leveling Loops.	3-16	5-7.	Out-of-Circuit Transistor Resistance Measurements	5-31
5-1.	Test Equipment Required for Maintenance	5-2	5-8.	Safe Ohmmeter Range for Transistor Resistance Measurements	5-33
5-2.	Performance Tests	5-3	5-9.	Checks Following Tube, Semiconductor Replacement	5-34
5-2A.	Summary of Serial Prefix 803- Changes	5-15	5-10.	Etched Circuit Soldering Equipment . .	5-35
5-3.	Test Equipment Required for Adjustments and or Troubleshooting.	5-16	6-1.	Reference Designation Index	6-2
			6-2.	Replaceable Parts	6-18
			6-3.	Code List of Manufacturers	6-25

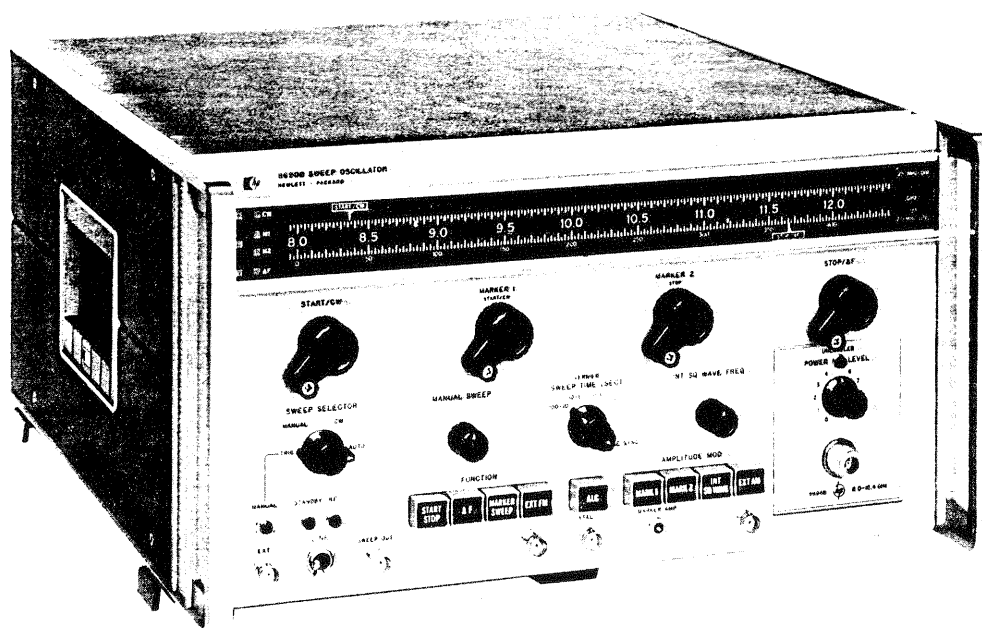

Figure 1-1. Model 8690B with RF Unit Installed

SECTION I

GENERAL INFORMATION

1-1. DESCRIPTION.

1-2. The HP 8690B Sweep Oscillator, when used with one of the 8690-series RF Units, comprises an electronically tuned signal source. The RF Units used with the 8690B Sweep Oscillator are of the following basic types:

LOW FREQUENCY

- 1) Solid-state with leveled and calibrated output. Model 8698A/B, 8699B.

MICROWAVE

- 1) PIN modulated with coaxial output. Models 8691-4B.
- 2) Grid modulated with coaxial output. Models 8691-4A.
- 3) Grid modulated with waveguide output. Models 8695-7A.

1-3. A summary of specifications covering the Sweep Oscillator/RF Unit combinations is given in Table 1-1. Detailed specifications of 8690B with 8691-7A/B RF Units are given in Table 1-2.

1-4. The Sweep Oscillator provides three linear automatic sweeps: two broadband, and one narrowband. The broadband sweeps each have independent, calibrated start and stop frequencies which are continuously adjustable over the entire frequency range of the Oscillator-RF Unit to permit sweeping up or down in frequency. The narrowband sweep varies the RF output upward through a 0 to 10% segment of the frequency range, the segment being centered anywhere in the Oscillator-RF Unit range.

1-5. One of the broadband sweeps has two internally-generated, calibrated frequency markers. The markers, individually activated and separately tuned, occur as triangular notches in the RF output. The markers may also be used with the narrowband sweep and with external frequency modulation.

1-6. Modulation capability includes internal square wave, external amplitude and external frequency modulation. Square-wave frequency is continuously variable between 950 and 1050 Hz.

1-7. RF output power level is manually adjustable and there is provision for automatic output leveling. As an indication of leveling performance, a panel light lights automatically if any segment of the sweep is unlevelled.

1-8. Internal leveling may be ordered as an option on microwave RF Units. A microwave RF Unit with internal leveling is designated by Option 001, and is available on RF Unit Model 8691-4A and 8693-4B. Internal leveling allows the Sweep Oscillator to automatically hold amplitude constant as output frequency changes.

1-9. Provision for oscilloscope and graphic recorder display of swept-frequency measurements includes RF shut-off (blanking) and penlift between sweeps, manual sweep control, a linear sawtooth voltage output concurrent with the sweep (to provide frequency reference for the display), and visual indication of sweep duration.

1-10. The microwave RF Unit signal source is a backward-wave oscillator tube (BWO), a self-contained, voltage-tunable oscillator. Fail-safe, over-load, and time delay circuits protect the BWO from power supply malfunctions and turn-on transients.

1-11. The 8690B Sweep Oscillator and 8690-series RF Units combine to permit rapid, broadband evaluation of low frequency and microwave device performance, serving as the swept-frequency source for measuring such transmission properties as reflection coefficient, attenuation, gain, directivity, and other network transfer characteristics.

1-12. INSTRUMENTS COVERED BY MANUAL

1-13. This instrument has a two-part serial number. The first four digits and the letter comprise the serial number prefix. The last five digits form the sequential suffix that is unique to each instrument. The contents of this manual apply directly to instruments having the same serial number prefix (es) as listed under SERIAL NUMBERS on the title page.

1-14. An instrument manufactured after the printing of this manual may have a serial prefix that is not listed on the title page. This unlisted serial prefix indicates that the instrument is different from those documented in this manual. The manual for this instrument is supplied with a yellow Manual Changes supplement that contains "change information" that documents the differences.

1-15. In addition to change information, the supplement may contain information for correcting errors in the manual. To keep this manual as current and accurate as possible, Hewlett-Packard recommends that you periodically request the latest Manual Changes supplement. The supplement for this manual is keyed to this manual's print date and part number, both of which appear on the title page. Complimentary copies of the supplement are available from Hewlett-Packard.

1-16. For information concerning a serial number prefix not listed on the title page or in the Manual Changes supplement, contact your nearest Hewlett-Packard office.

Table 1-1. Summary of Specifications

Sweep Oscillator/RF Unit	Frequency Range	Max. Leveled Power Output	Frequency Accuracy
8690B	--	--	--
8691A	1 - 2 GHz	≥ 100 mW	±1%
8691A Option 200	1.4 - 2.5 GHz	≥ 100 mW	±1%
8691B	1 - 2 GHz	≥ 70 mW	±10 MHz
8692A	2 - 4 GHz	≥ 70 mW	±1%
8692B	2 - 4 GHz	≥ 40 mW	±20 MHz
8692B Option 100	1.7 - 4.2 GHz	≥ 15 mW	±25 MHz
8693A	4 - 8 GHz	≥ 30 mW	±1%
8693A Option 200	3.5 - 6.75 GHz	≥ 40 mW	±1%
8693B	4 - 8 GHz	≥ 15 mW	±40 MHz
8693B Option 100	3.7 - 8.3 GHz	≥ 5 mW	±45 MHz
8694A	8 - 12.4 GHz	≥ 50 mW	±1%
8694A Option 100	7 - 12.4 GHz	≥ 25 mW	±1%
8694A Option 200	7 - 11 GHz	≥ 25 mW	±1%
8694B	8 - 12.4 GHz	≥ 30 mW	±40 MHz
8694B Option 100	7 - 12.4 GHz	≥ 15 mW	±50 MHz
8694B Option 200	7 - 11 GHz	≥ 15 mW	±40 MHz
8695A	12.4 - 18 GHz	≥ 40 mW	±1%
8695B	12.4 - 18 GHz	≥ 15 mW	±1%
8696A	18 - 26.5 GHz	≥ 10 mW	±1%
8697A	26.5 - 40 GHz	≥ 5 mW	±1%
8698A	0.1 - 110 MHz	100 mW	±1% of F. S.
8698B	0.4 - 110 MHz	20 mW	±1%
8699B	0.1 - 2.0 GHz	20 mW	±1%
	2.0 - 4.0 GHz	≥ 6.5 mW	

Table 1-2. Specifications of 8690B Sweep Oscillator with RF Unit Installed

SWEEP FUNCTIONS

Start-Stop Sweep: Sweeps from "start" to "stop" frequency setting.

Range: Both settings continuously and independently adjustable over the entire frequency range; can be set to sweep either up or down in frequency.

End-point Accuracy: Same as RF Unit frequency accuracy.

Marker Sweep: Sweeps from "Marker 1" to "Marker 2" frequency setting.

Range: Both settings continuously and independently adjustable over the entire frequency range; can be set to sweep either up or down in frequency.

End-point Accuracy: Same as RF Unit frequency accuracy.

ΔF Sweep: Sweeps upward in frequency, centered on CW setting.

Width: Continuously adjustable from zero to 10% of the frequency band; calibrated directly in MHz.

Width Accuracy: $\pm 10\%$ of ΔF being swept $\pm 1\%$ of maximum ΔF ($\pm 20\%$ $\pm 2\%$ respectively with 8691A/B RF Units).

Center-frequency Accuracy: Same as RF Unit frequency accuracy.

FREQUENCY MARKERS

Two frequency markers, independently adjustable over the entire frequency range, amplitude modulate the RF output. Amplitude is adjustable from the front panel. The markers are also available for external use.

Accuracy: 1% of full scale for all RF Units.

Resolution: Better than 0.05% of RF Unit bandwidth.

Marker Output: Triangular pulse, typically -5 V peak into 1000-ohm load.

CW OPERATION

Single-frequency RF output selected by START/CW or MARKER 1 control, depending upon sweep function selected.

Accuracy: Same as RF Unit frequency accuracy.

Preset Frequencies: Start-stop sweep end points and marker frequencies can be used as four preset CW frequencies.

SWEEP MODE

Auto: Sweep recurs automatically.

Manual: Front-panel control provides continuous manual adjustment of frequency between end frequencies set in any of the above sweep functions.

Triggered: Sweep is actuated by front-panel push button or by externally applied signal between -7.5V and -25V, $> 1 \mu\text{sec}$ pulse width, and $> 0.1 \text{ V}/\mu\text{sec}$ rise.

SWEEP CHARACTERISTICS

Sweep Time: Continuously adjustable in four decade ranges, 0.01 to 100 seconds. Can be synchronized with the power line frequency.

Sweep Indicator: Front-panel indicator lights during the sweep to provide indication of sweep duration on slower sweep times.

Sweep Output: Direct-coupled sawtooth, zero to approx. +15 V, concurrent with swept RF output. Zero at start of sweep, approximately +15 V at end of sweep regardless of sweep width or direction. Source impedance, 10,000 ohms.

Frequency Linearity: (Correlation between frequency and both the sweep and reference output.) Same as RF Unit frequency accuracy.

Blanking: RF automatically turned off during retrace, turned on after completion of retrace. On automatic sweeps, RF is on long enough before sweep starts to stabilize external circuits and equipment whose response is compatible with the selected sweep rate. Blanking disable switch provided.

Blanking Output: Direct-coupled rectangular pulse approximately -4 V coincident with RF blanking. Source impedance approximately 3000 ohms.

Penlift: For use with X-Y graphic recorders. Penlift terminals shorted during sweep, open during retrace (100-10 and 10-1 sec ranges only).

POWER LEVELING AMPLIFIER

Internal dc-coupled leveling amplifier provided.

Crystal Input: Approximately -20 to -350 mV for specified leveling at rated output; for use with negative-polarity detectors such as 780 series Directional Detectors, 423 and 424 series Crystal Detectors.

MODULATION

Internal AM: Square wave modulation continuously adjustable from 950 to 1050 Hz on all sweep times. On/off ratio greater than 20 dB at rated output.

Table 1-2. Specifications of 8690B Sweep Oscillator with RF Unit Installed (Cont'd)

External AM

Frequency Response: dc to 350 kHz unlevelled, dc to 50 kHz leveled.

Sensitivity: -10 V reduces RF output level at least 30 dB below rated CW output ("A" Model RF Units, 20 dB for "B" Models).

Input Impedance: Approximately 1000 ohms.

External FM

Frequency Response: dc to 3 kHz.

Sensitivity: Deviation from CW setting approximately 6% of the frequency band per volt.

Maximum Range: Full band for modulation frequencies up to 150 Hz (approximately 17 V pp input), decreases to about 20% of the band for 3 kHz modulation.

Input Impedance: Approximately 100,000 ohms.

GENERAL

Power: 115 or 230 Vac $\pm 10\%$, 48 to 66 Hz. Approximately 350 watts with one RF Unit; if RF Unit holder HP 8707A is used add approximately 300 watts for each RF Unit.

Available:

Directional Couplers	776/777	Coaxial Dual coupler, 1 to 4 GHz, 20 dB coupling, high directivity
	790 series	Ultra-flat coaxial coupler, 1 to 8.3 GHz, high directivity
	752 series	Waveguide coupler, 2.6 to 40 GHz, 40 dB directivity
Directional Detectors	781-789 series	Ultra-flat coupler with built-in detector, 1-12.4 GHz
Detectors	423	Coaxial crystal detector, 0.01 to 12.4 GHz, flat response
	424 series	Waveguide crystal detector, 2.6 to 18 GHz, flat response
	422	Waveguide crystal detector, 18 to 40 GHz, ± 2 dB response
	478	Coaxial thermistor mount for 432, 0.01 to 10 GHz
	486 series	Waveguide thermistor mounts for 431, 2.6 to 40 GHz
Power Meter	432	10 μ W to 10 mW full scale.
Adapter	281 series	Coax to waveguide adapter, 2.6 to 12.4 GHz
Loads, Shorts	906	Coaxial sliding load, 1 to 12.4 GHz, low load SWR
	11511/11512	Coaxial fixed short, 11511 female, 11512 male
	910 series	Waveguide termination, 2.6 to 18 GHz, low SWR
	914 series	Waveguide moving load, 2.6 to 40 GHz, 1.01 load SWR
	X923/920 series	Waveguide adjustable short 2.6 to 40 GHz
Ref. Coeff. Bridge	X8440	Reflection coefficient measurements in coax, 8.2 to 12.4 GHz
Oscilloscopes, X-Y Recorders	140/1416	Oscilloscope, calibration in dB/cm, high sensitivity
	130	Oscilloscope, calibration in V/cm, high sensitivity
	7035, Opt 01	X-Y recorder with AUTOGRIP hold down, high sensitivity
Filters	360	Low pass filters; cut off at 2.2 and 4.1 GHz
	8430 series	Bandpass filters, octave and semi-octave, 1-12.4 GHz

Dimensions:

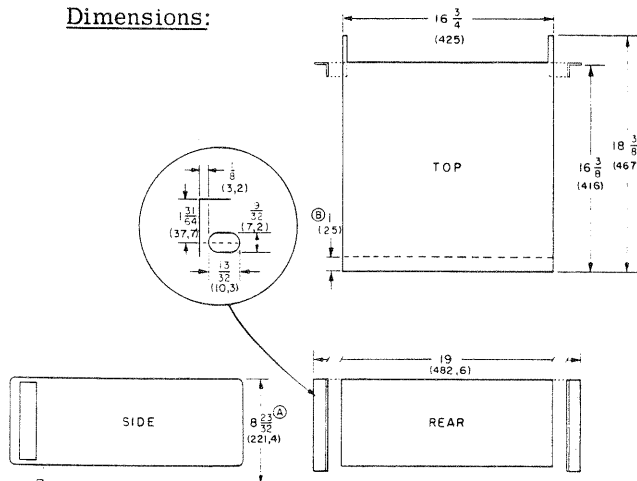

NOTES
DIMENSIONS IN INCHES AND (MILLIMETERS)
① EIA RACK HEIGHT
② FOR CABINET HEIGHT (INCLUDING FEET) ADD $\frac{5}{16}$ (8.0) TO EIA RACK HEIGHT
③ REAR APRON RECESS

Weight (not including RF Unit): Net, 53 lbs. (23,9 kg). Shipping, 71 lbs. (32 kg).

Furnished: 7-1/2 ft (2290 mm) power cable with NEMA plug; rack mounting kit.

SECTION II INSTALLATION

2-1. INCOMING INSPECTION.

2-2. The Sweep Oscillator was carefully inspected, both mechanically and electrically, prior to shipment. Inspect it for mechanical damage received in transit, check for supplied accessories, and test electrical performance using the performance tests in Section V. If there is any damage or deficiency, or if electrical performance is not within specifications, see the warranty inside the front cover of this manual.

2-3. PREPARATION FOR USE.

2-4. POWER REQUIREMENTS.

2-5. The Sweep Oscillator requires a power source of 115 or 230 volts $\pm 10\%$, 50 to 60 Hz, single phase, which can supply approximately 350 watts.

2-6. 115/230 VOLT OPERATION.

2-7. A two-position slide switch, on the rear panel under the power line fuseholder, permits operation from either a 115- or 230-volt power source. The number visible on the switch slider indicates the line voltage for which the instrument is connected. Adjacent to the switch is the correct fuse rating for each line voltage.

2-8. To prepare the Sweep Oscillator for operation, position the 115-230 volt switch so that the number visible on the slider corresponds to the available line voltage, and install a fuse of correct rating.

CAUTION

To avoid damage to the Sweep Oscillator, set the 115-230 volt switch for the line voltage to be used BEFORE connecting the power cable.

Note

Fuse ratings when using 8690B with 8706A and 8707A:

No. of RF Units	Acceptable Range of Fuse Rating	
	115V	230V
1	4 - 6 amps	2 - 3 amps
2	4 - 6.5 amps	2 - 3.5 amps
3	4.5 - 7.5 amps	2.25 - 4 amps
4	5 - 8.5 amps	2.5 - 4.5 amps
5	5.5 - 9 amps	2.75 - 5 amps
6	6 - 10 amps	3 - 5.5 amps
7	6.5 - 10.5 amps	3.25 - 6 amps
8	7 - 12 amps	3.5 - 7 amps
9	7 - 12 amps	3.5 - 7 amps

2-9. POWER CABLE.

2-10. To protect operating personnel, the National Electrical Manufacturers' Association (NEMA) recommends that the Sweep Oscillator panel and cabinet be grounded. Accordingly, the Sweep Oscillator is equipped with a three-conductor power cable which, when plugged into an appropriate receptacle, grounds the panel and cabinet. The offset pin of the three-prong connector is the ground pin.

2-11. To preserve the protection feature when operating the Oscillator from a two-contact outlet, use a three-prong to two-prong adapter (HP Stock No. 1251-0048) and connect the green pigtail on the adapter to ground.

2-12. COOLING.

2-13. Forced air cooling is used to maintain safe operating temperatures within the Sweep Oscillator and RF Unit. The air intake and exhaust ports, cooling fan, and air filter are located at the rear of the instrument. To ensure adequate ventilation, maintain about three inches of clearance behind the cabinet.

CAUTION

Do not operate the Sweep Oscillator if the fan is not operating.

2-14. RF UNIT AIR FILTER.

2-15. The air filter, as received with a new instrument, has a coating of dust-catching substance which improves air cleaning action. To maintain adequate ventilation, clean and recoat the air filter at regular intervals. See Section V for cleaning instructions.

2-16. MAGNETIC INTERFERENCE.

2-17. When using Model 8691A/B RF Units, do not locate the Sweep Oscillator in the vicinity of a strong magnetic field; magnetic interference can be detrimental to performance.

2-18. BENCH USE.

2-19. The Sweep Oscillator cabinet has plastic feet and a foldaway tilt stand for convenience in bench operation. The tilt stand permits inclining the instrument for more convenient viewing of the control panel, and the plastic feet are shaped to make full width modular instruments self-aligning when stacked.

2-20. For portability and protection in transit, accessory Control Panel Covers are available for the Sweep Oscillator. These are metal covers which fit between the handles at the front of the instrument. Each cover has a carrying handle and is readily fastened in place by two pushbutton latches. To obtain a Control Panel Cover for the Model 8690B, order HP Stock No. 5060-0829.

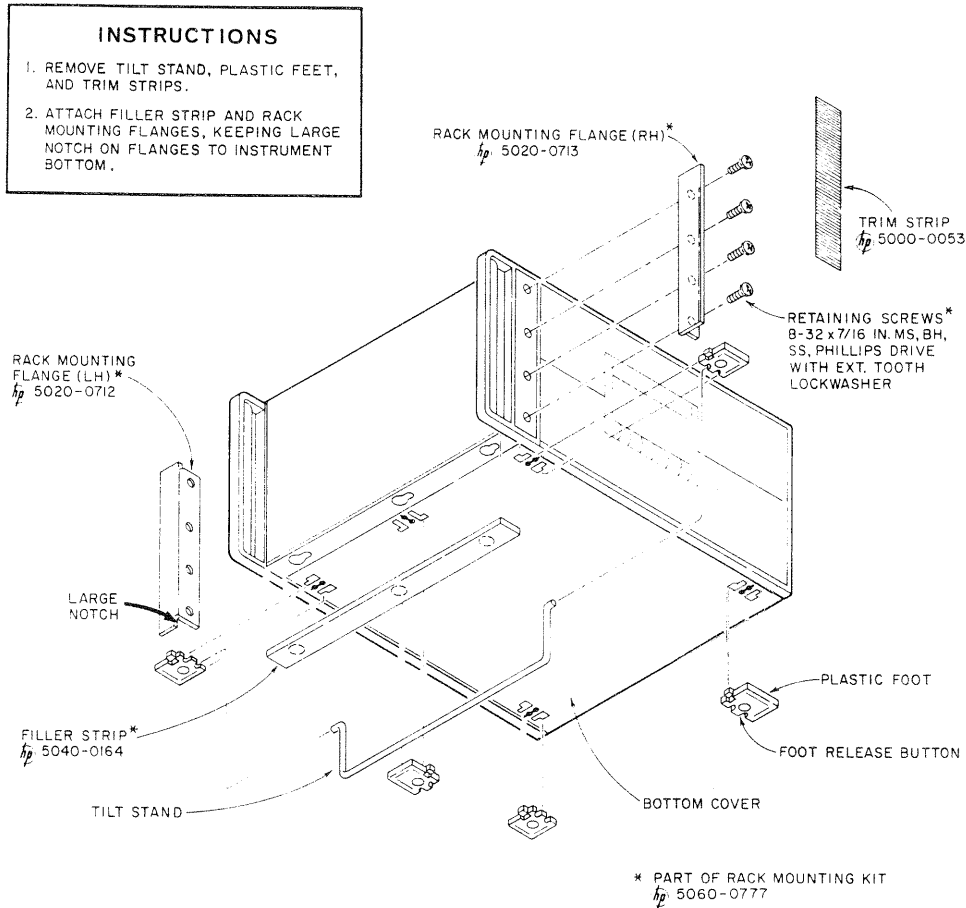

Figure 2-1. Preparation for Rack Mounting

2-21. RACK MOUNTING.

2-22. Preparation for rack mounting is illustrated in Figure 2-1. All necessary hardware is contained in the rack mounting kit supplied with the Sweep Oscillator.

Note

If the rack-mounted instrument will be subjected to shock or vibration, provide additional bracing at the rear of the cabinet.

2-23. REPACKAGING FOR SHIPMENT.

2-24. If the Sweep Oscillator is to be packaged for shipment use the original shipping container and packing materials. If these have been discarded or are not in condition for reuse, contact your local Hewlett-Packard sales and service office (see rear of this manual for locations), or follow these general instructions.

a. Wrap the Sweep Oscillator in heavy paper or plastic. (If the instrument is being shipped to a Hewlett-Packard service facility, attach a tag indicating type of servicing required, return address, model number, and full serial number.)

b. Use a strong shipping container. A carton made of 600 pound test material will usually provide adequate protection.

c. Use enough shock-absorbing material (3 to 4 inch layer) around all sides of the instrument to provide firm cushion and prevent movement inside the container. Protect the control panel with cardboard. With Hewlett-Packard "floaters pack" packaging, the foam blocks provide sufficient shock protection, and additional material is unnecessary.

d. Seal the shipping container securely.

e. Mark the shipping container "FRAGILE" to assure careful handling.

Note

Because of the permanent magnetic field of Model 8691A/B RF Unit BWO, the Sweep Oscillator should not be shipped by air unless packaged to conform with air shipment regulations.

2-25. In any correspondence refer to the Sweep Oscillator by model number and full serial number.

SECTION III OPERATION

3-1. INTRODUCTION.

3-2. The 8690B Sweep Oscillator, when used with one of the 8690-series RF Units comprises an electronically tuned microwave signal source. Each Oscillator is capable of four types of sweep: start-stop, marker, ΔF , and external FM. The first three sweeps are internally generated, while external FM permits remote tuning. The internally-generated sweeps have adjustable, calibrated end points and sweep times as well as a choice of sweep modes. The FM sweep has an adjustable CW frequency.

3-3. For start-stop sweeping independent controls determine the start and stop frequencies. Each frequency can be set anywhere within the RF Unit frequency range allowing output frequency to increase or decrease with time.

3-4. Marker sweep is the same as start-stop sweep except for a separate set of tuning controls and frequency registers.

3-5. ΔF sweep is a narrowband, variable-width sweep centered on a CW frequency. The CW frequency can be set anywhere within the range of the RF Unit, and sweep width is variable from 0 to 10 percent of the RF Unit frequency range.

3-6. For external FM sweep operation, any frequency within the RF Unit frequency range can be selected as the CW frequency with RF sweep width, rate and symmetry controlled by the externally-generated FM signal.

3-7. For start-stop sweeping, two internal RF frequency markers can be individually positioned anywhere within the selected sweep range. Each marker is produced by amplitude modulation of the RF output at the frequency selected. Since each marker is push-button-selected, one or both markers can be used. The triangular marker pulses are available at a rear-panel output and there is amplitude control for the RF-modulating pulses.

3-8. Common to all three internal sweeps are the sweep modes, the sweep time selector, and modulation capabilities. Each sweep may be automatically recurrent, manual, or triggered. Automatically recurrent sweeping can be synchronized with the power line frequency by rotating the vernier of the sweep time selector to a detent position. In the manual sweep mode output frequency variation is operator-controlled. In the trigger mode sweeping is initiated either by a front-panel pushbutton or by external negative signals.

3-9. For CW operation, either of two controls can be used to set the output frequency: the start control

of the start-stop sweep or the start control of the marker sweep. Each control is calibrated and has the full frequency range of the RF Unit.

3-10. The Sweep Oscillator-RF Unit combination has provision for automatic leveling of output power. Normally, however, output power is unlevelled and has the power-frequency characteristic of the RF oscillator. For both leveled and unlevelled operation, the POWER LEVEL control on the RF Unit is an uncalibrated output attenuator.

3-11. Automatic leveling maintains output power constant as frequency changes and is achieved by a closed loop feedback system. A typical leveling system consists of a directional coupler for obtaining an RF sample of known proportion, a crystal detector to sense the RF level variations, and an amplifier to furnish a signal of appropriate polarity and magnitude to control the RF source and maintain RF output constant. In practice, power is not held absolutely constant, but variations can be confined within narrow limits.

3-12. Option 001 RF Units have a complete internal leveling system activated by a front panel pushbutton. Standard Sweep Oscillator-RF Unit combinations contain only the loop amplifier mentioned above.

3-13. Provisions for oscilloscope or graphic recorder display of swept-frequency measurements include a sawtooth voltage output of constant amplitude which can be used as a time base or frequency axis, pen lift on the two slowest sweeps to raise X-Y recorder pens between sweeps, RF shut-off (blanking) between sweeps, manual trigger and manual sweep for display calibration, and visual indication of sweep duration for positive determination of sweep start and stop.

3-14. GENERAL OPERATING INFORMATION.

3-15. RF OUTPUT CONNECTOR.

3-16. 8691-4A/B, 8699B RF Units, except Option 001 Models, have standard 50-ohm type N coaxial output connectors. The Option 001 Models have HP precision 50-ohm type N coaxial connectors which are intended for coupling to standard type N connectors (e.g., UG-21D/U) only. CAUTION: Do not couple two HP precision connectors. Dimensions of the precision connector mating parts are such that coupling two precision connectors can result in connector damage and/or damage to devices having plated type (strip) transmission lines fastened directly to the precision connector. Since the Option 001 Models utilize the precision output connector of an HP strip line directional detector as the RF output connector, other HP devices having HP precision connectors must not be coupled directly to the RF Unit.

3-17. OUTPUT POWER RANGE.

3-18. Refer to Table 1-1 for RF power output specifications.

3-19. RF INPUT LIMITATION.

3-20. Excessive reverse RF power applied to the RF output connector can damage the solid state attenuator-modulator in the B Model RF Units, or the backward-wave oscillator tube in A Model RF Units.

CAUTION

Never apply more than 1 watt RF (CW or peak pulse) from an external source to the RF Unit power output connector.

3-21. BWO LIFE.

3-23. Since operating practices affect useful tube life,

a. always provide adequate ventilation for the interior of the Oscillator by maintaining at least three inches of clearance at the rear of the cabinet;

b. ensure that the air filter is clean; and

c. avoid prolonged operation of the Sweep Oscillator with the LINE switch at STANDBY. Although there is no RF output in this state, the BWO heater is energized.

3-24. MAGNETIC INTERFERENCE.

3-25. Sweep Oscillator performance can be adversely affected by strong external magnetic fields such as those produced by magnetrons and large transformers.

3-26. CONTROLS, CONNECTORS & INDICATORS.

3-27. Front- and rear-panel controls, connectors, and indicators are shown and described in Figures 3-1 and 3-2. Locations and descriptions apply to all 8690B Sweep Oscillator-8690 series RF Unit combinations.

3-28. BASIC OPERATING PROCEDURES.

3-29. TURN-ON.

a. Set rear-panel 115-230 switch to match line voltage before connecting the power cord to the service outlet. Check that the line fuse has correct rating. (Correct fuse rating is directly above the visible number on the switch slider.)

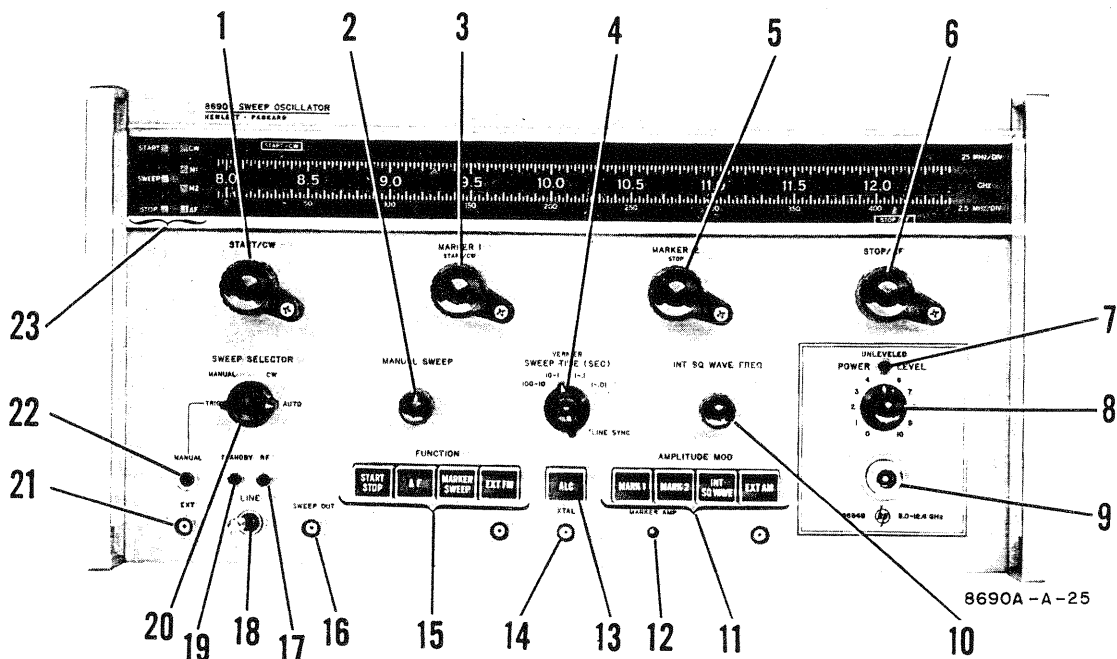
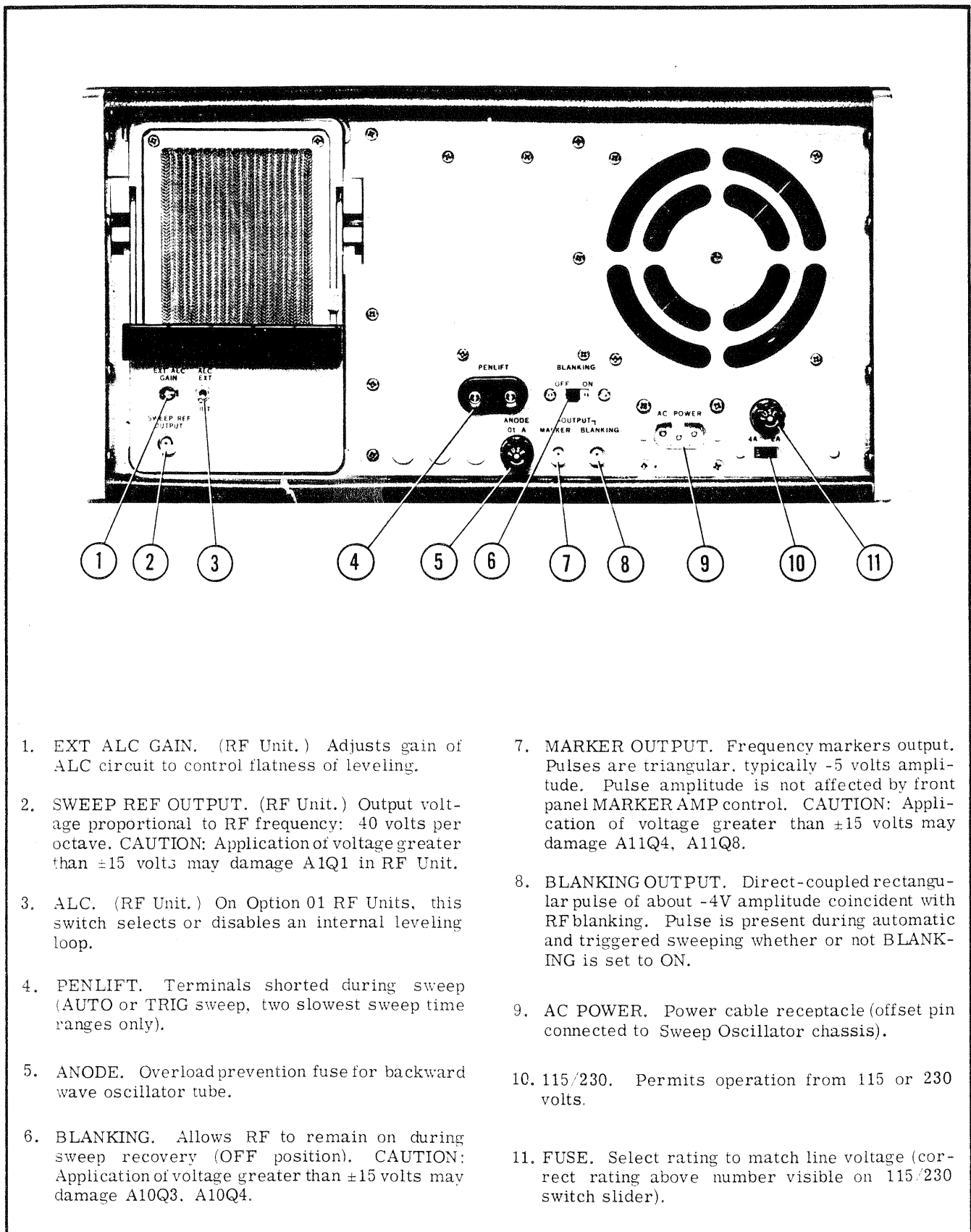

Figure 3-1. Front Panel Controls, Connectors, and Indicators

1. START/CW. Selects start frequency for start-stop sweep, CW frequency for CW operation, mid-frequency for ΔF sweep on slide-rule GHz scale.
2. MANUAL SWEEP. Manually varies frequency between endpoints of start-stop, ΔF , or marker sweep (counterclockwise extreme gives start frequency).
3. MARKER 1. Selects marker 1 frequency or marker sweep start frequency.
4. SWEEP TIME (SEC). Selects range of sweep time. VERNIER varies sweep time within selected range (sweep time decreases with clockwise rotation). Detent position at clockwise extreme synchronizes sweep with power line frequency.
5. MARKER 2. Selects marker 2 frequency or marker sweep stop frequency.
6. STOP/ ΔF . Selects stop frequency for start-stop sweep on slide-rule GHz scale. frequency range for ΔF sweep on MHz scale.
7. UNLEVELED. Lights if POWER LEVEL set too high for leveling across selected frequency range.
8. POWER LEVEL. Adjusts RF amplitude.
9. RF Output Connector. Standard 50-ohm type N connector except on Option 01 Models which have hp precision 50-ohm type N connectors. See text.
10. INT SQ WAVE FREQ. Adjusts frequency of internal square wave modulation.
11. AMPLITUDE MOD. Select any combination of amplitude modulation: external amplitude modulation (apply signal to connector), markers, and internal square wave.
12. MARKER AMP. Adjusts amplitude of RF-modulating frequency markers, but does not affect rear-panel MARKER output.
13. ALC. Selects automatic RF leveling.
14. XTAL. Accepts leveling signal from crystal detector.
15. FUNCTION. Selects an internal sweep or external FM (SWEEP SELECTOR must be set to CW for external FM; apply FM signal to connector).
16. SWEEP OUT. Sweep voltage output (0 to +15V regardless of RF sweep width or direction).
17. RF. Indicator on when instrument is on and not in standby mode.
18. LINE. Controls line power to instrument; RF off in STANDBY; 1-min delay between OFF and RF.
19. STANDBY. Indicator on when instrument is on.
20. SWEEP SELECTOR. Selects mode of operation: CW, automatic sweep (free running or line synced), manual sweep, or triggered sweep.
21. EXT. Accepts external triggering signal when SWEEP SELECTOR is set to TRIG.
22. MANUAL. Pushbutton to start triggered sweep when SWEEP SELECTOR is set to TRIG.
23. START. Lights when START-STOP function mode is selected during automatic sweep.
SWEEP. Lights during sweep.
STOP. Lights when START-STOP function mode is selected during automatic sweep.
CW. Lights during CW operation or when ΔF function mode is selected.
M1, M2. Lights when MARKER SWEEP function mode is selected. M1 only lights when MARKER SWEEP function mode is selected during CW operation.
 ΔF . Lights when ΔF function mode is selected during AUTO MANUAL OR TRIG operation. Does not light during CW operation.

Figure 3-1. Front Panel Controls, Connectors, and Indicators (Continued)



1. EXT ALC GAIN. (RF Unit.) Adjusts gain of ALC circuit to control flatness of leveling.
2. SWEEP REF OUTPUT. (RF Unit.) Output voltage proportional to RF frequency: 40 volts per octave. CAUTION: Application of voltage greater than ± 15 volts may damage A1Q1 in RF Unit.
3. ALC. (RF Unit.) On Option 01 RF Units, this switch selects or disables an internal leveling loop.
4. PENLIFT. Terminals shorted during sweep (AUTO or TRIG sweep, two slowest sweep time ranges only).
5. ANODE. Overload prevention fuse for backward wave oscillator tube.
6. BLANKING. Allows RF to remain on during sweep recovery (OFF position). CAUTION: Application of voltage greater than ± 15 volts may damage A10Q3, A10Q4.
7. MARKER OUTPUT. Frequency markers output. Pulses are triangular, typically -5 volts amplitude. Pulse amplitude is not affected by front panel MARKER AMP control. CAUTION: Application of voltage greater than ± 15 volts may damage A11Q4, A11Q8.
8. BLANKING OUTPUT. Direct-coupled rectangular pulse of about -4V amplitude coincident with RF blanking. Pulse is present during automatic and triggered sweeping whether or not BLANKING is set to ON.
9. AC POWER. Power cable receptacle (offset pin connected to Sweep Oscillator chassis).
10. 115/230. Permits operation from 115 or 230 volts.
11. FUSE. Select rating to match line voltage (correct rating above number visible on 115/230 switch slider).

Figure 3-2. Rear Panel Controls and Connectors

b. Ensure the RF Unit is firmly seated into position and the locking handle is secured before applying power.

c. Connect Sweep Oscillator to power source.

d. Set front-panel LINE switch to RF. After about one to two minutes delay the RF indicator should glow. Failure of the indicator to glow is an indication of malfunction.

CAUTION

Do not use the Sweep Oscillator if the cooling fan does not operate when power is turned on.

3-30. STANDBY OPERATION.

3-31. When the LINE switch is set to STANDBY there is no RF output, but heaters of all electron tubes are energized and operating potentials are supplied to all circuits except the RF oscillator. This condition permits nearly immediate RF output when the LINE switch is set to RF, provided at least one minute has elapsed between OFF and STANDBY.

3-32. With no FUNCTION selectors depressed, the CW dial lamp will glow regardless of the settings of other controls.

3-33. SWEEP FUNCTIONS.

3-34. The Sweep Oscillators have four sweep functions which are designated Start-Stop, ΔF , Marker, and External FM. Four separate pushbuttons, each labeled for the function it selects, determine the type of swept-frequency operation.

3-35. START-STOP SWEEP.

3-36. For the start-stop sweep function, the sweep start and stop frequencies are separately adjustable to any frequency within the range of the RF Unit. Since the output frequency varies from the start frequency to the stop frequency, sweeping can be either up or down with time. In addition, sweeping can be automatically recurrent, triggered or manual, with variable sweep time for recurrent and triggered sweeping. All amplitude modulation capabilities can be used with the start-stop sweep and output power may be leveled or unlevelled. Instructions for obtaining start-stop sweep are given in Figure 3-3.

3-37. ΔF SWEEP.

3-38. With ΔF sweep, output frequency varies upward through a segment of the RF Unit frequency range which is adjustable in width from zero to 10% of full range and centered on any frequency within the RF Unit range. All trigger and amplitude modulation capabilities may be used and sweep time, in the automatic and triggered modes, can be varied from 10 milliseconds to 100 seconds. RF output power may be leveled or unlevelled. Figure 3-4 gives instructions for obtaining ΔF sweep.

3-39. MARKER SWEEP.

3-40. Marker sweep is similar to start-stop sweep with individual start and stop frequency controls and frequency registers which are separate from those of the start-stop sweep. The only functional difference between start-stop and marker sweep is that the RF frequency markers cannot be used with the marker sweep. Figure 3-5 gives instructions for obtaining marker sweep.

3-41. EXT FM.

3-42. The External FM function provides a means of obtaining output frequency which varies under the control of an externally-produced signal. Output frequency variation that is linear with time results from application of a voltage variation which is also linear with time. Positive-going voltage causes output frequency to increase while negative-going voltage causes output frequency to decrease. Maximum upward deviation is the full frequency range of the RF Unit, but downward deviation is restricted to approximately one-half the frequency range. The CW frequency of the FM sweep is calibrated and manually adjustable over the full frequency range. When the CW frequency is set below mid-range, total deviation can be the full frequency range. The external FM input is direct-coupled to permit remote frequency programming.

3-43. During external FM operation both the SWEEP SELECTOR and SWEEP TIME switch are inoperative, but there is full amplitude modulation capability and RF output power may be leveled or unlevelled. Instructions for external FM operation are given in Figure 3-6.

3-44. FM LIMITATIONS.

CAUTION

The Sweep Oscillator can be damaged by application of FM signals which exceed the safe operating limits given in the charts of Figure 3-7.

Chart A gives the percent of frequency range swept for each CW setting and FM input voltage (external FM signal frequencies less than 150 Hz). Chart B gives voltage limits for external FM signal frequencies above 150 Hz.

3-45. NEVER EXCEED THE FM VOLTAGE LIMITS GIVEN IN CHARTS A AND B OF FIGURE 3-7. Where there is a difference between limits indicated by charts A and B always use the smaller amplitude.

3-46. SWEEP MODES.

3-47. The sweep modes are designated TRIG, MANUAL, CW, and AUTO, the mode in use being determined by the setting of the SWEEP SELECTOR.

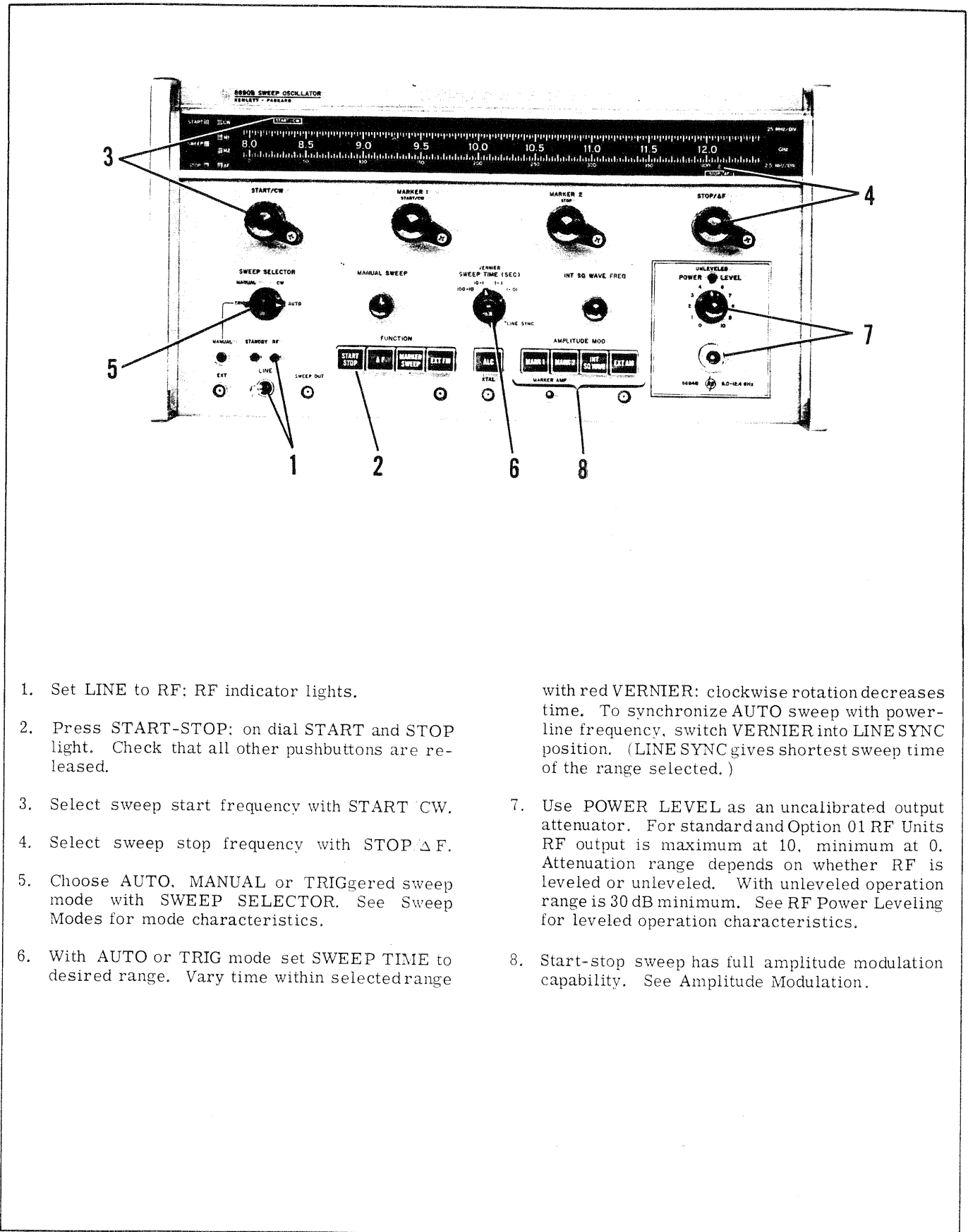

1. Set LINE to RF; RF indicator lights.
2. Press START-STOP; on dial START and STOP light. Check that all other pushbuttons are released.
3. Select sweep start frequency with START CW.
4. Select sweep stop frequency with STOP Δ F.
5. Choose AUTO, MANUAL or TRIGgered sweep mode with SWEEP SELECTOR. See Sweep Modes for mode characteristics.
6. With AUTO or TRIG mode set SWEEP TIME to desired range. Vary time within selected range

7. Use POWER LEVEL as an uncalibrated output attenuator. For standard and Option 01 RF Units RF output is maximum at 10, minimum at 0. Attenuation range depends on whether RF is leveled or unleveled. With unleveled operation range is 30 dB minimum. See RF Power Leveling for leveled operation characteristics.
8. Start-stop sweep has full amplitude modulation capability. See Amplitude Modulation.

Figure 3-3. Start-Stop Sweep Operation

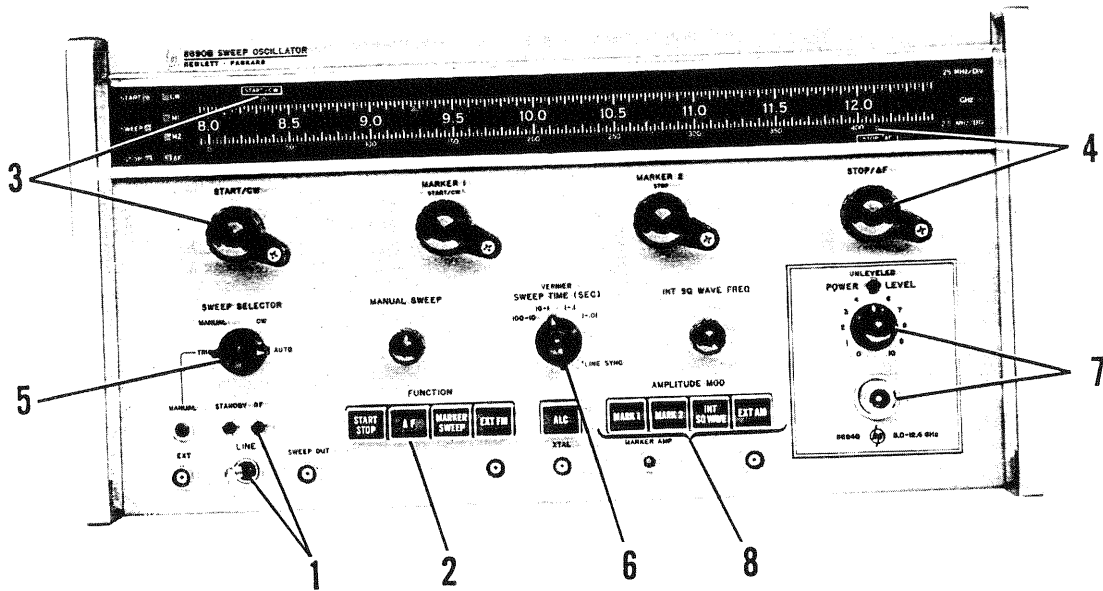

1. Set LINE to RF; RF indicator lights.
2. Press ΔF ; on dial, CW and ΔF light. Check that all other pushbuttons are released.
3. Select sweep center frequency with START/CW.
4. Select sweep width on MHz scale with STOP/ ΔF .
5. Choose AUTO, MANUAL, or TRIGgered sweep mode with SWEEP SELECTOR. See Sweep Modes for mode characteristics.
6. With AUTO or TRIG mode set SWEEP TIME to desired range. Vary time within selected range with red VERNIER: clockwise rotation decreases

7. Use POWER LEVEL as an uncalibrated output attenuator. For standard and Option 01 RF Units RF output is maximum at 10, minimum at 0. Attenuation range depends on whether RF is leveled or unleveled. With unleveled operation range is 30 dB minimum. See RF Power Leveling for leveled operation characteristics.
8. ΔF sweep has full amplitude modulation capability. See Amplitude Modulation.

Figure 3-4. ΔF Sweep Operation

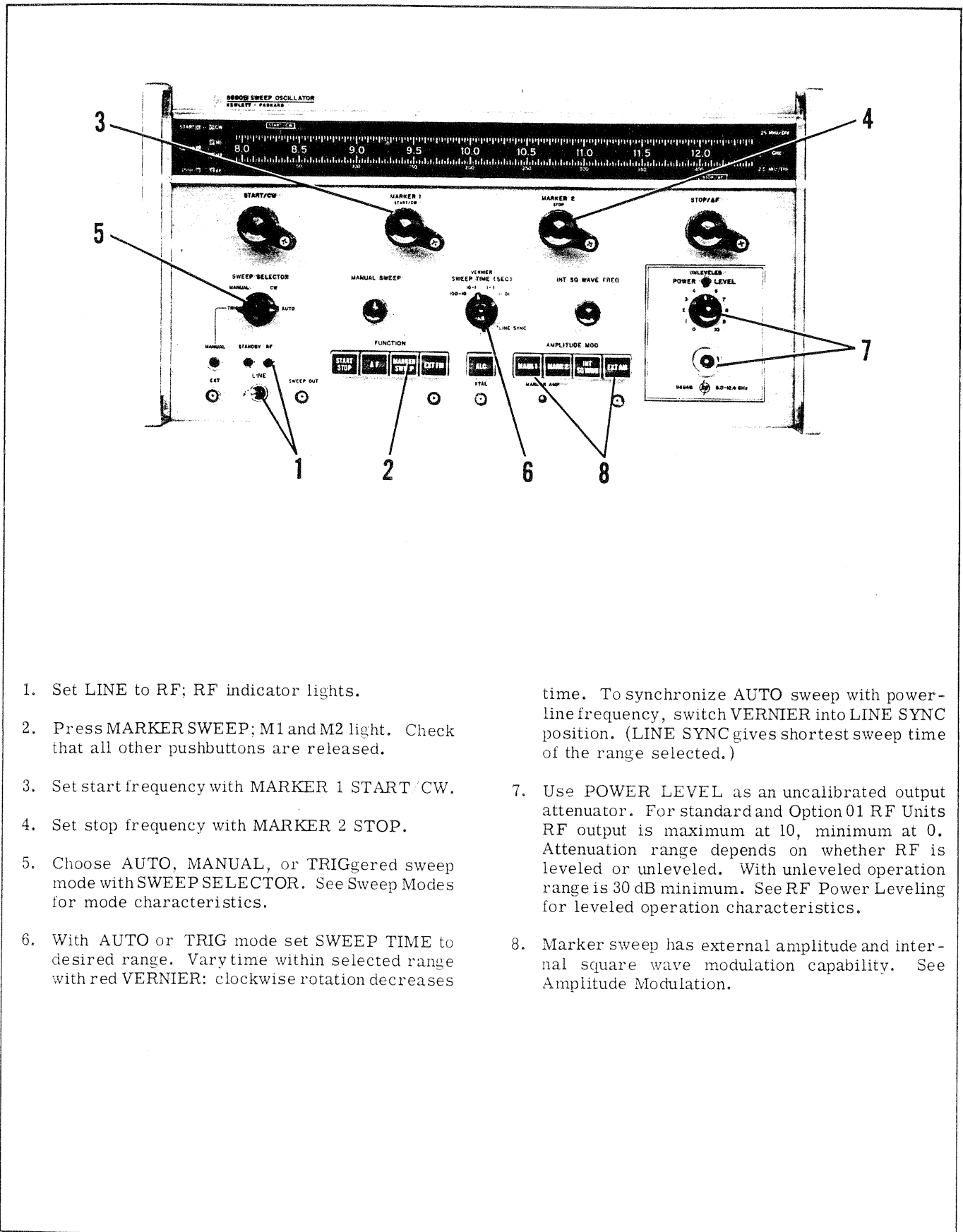

1. Set LINE to RF; RF indicator lights.
2. Press MARKER SWEEP; M1 and M2 light. Check that all other pushbuttons are released.
3. Set start frequency with MARKER 1 START/CW.
4. Set stop frequency with MARKER 2 STOP.
5. Choose AUTO, MANUAL, or TRIGgered sweep mode with SWEEP SELECTOR. See Sweep Modes for mode characteristics.
6. With AUTO or TRIG mode set SWEEP TIME to desired range. Vary time within selected range with red VERNIER: clockwise rotation decreases time. To synchronize AUTO sweep with power-line frequency, switch VERNIER into LINE SYNC position. (LINE SYNC gives shortest sweep time of the range selected.)
7. Use POWER LEVEL as an uncalibrated output attenuator. For standard and Option 01 RF Units RF output is maximum at 10, minimum at 0. Attenuation range depends on whether RF is leveled or unleveled. With unleveled operation range is 30 dB minimum. See RF Power Leveling for leveled operation characteristics.
8. Marker sweep has external amplitude and internal square wave modulation capability. See Amplitude Modulation.

Figure 3-5. Marker Sweep Operation

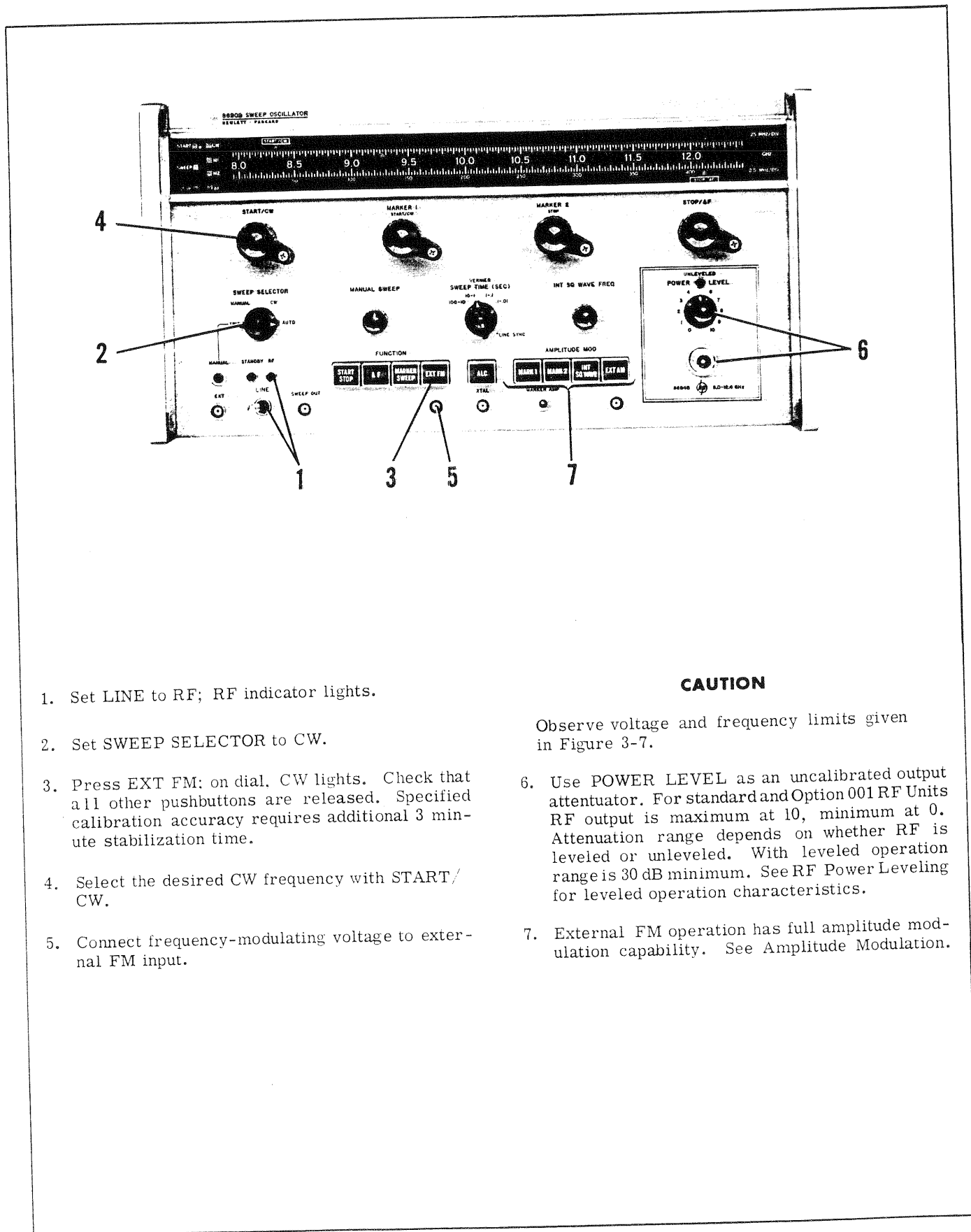

1. Set LINE to RF; RF indicator lights.
2. Set SWEEP SELECTOR to CW.
3. Press EXT FM; on dial, CW lights. Check that all other pushbuttons are released. Specified calibration accuracy requires additional 3 minute stabilization time.
4. Select the desired CW frequency with START/CW.
5. Connect frequency-modulating voltage to external FM input.

CAUTION

Observe voltage and frequency limits given in Figure 3-7.

6. Use POWER LEVEL as an uncalibrated output attenuator. For standard and Option 001 RF Units RF output is maximum at 10, minimum at 0. Attenuation range depends on whether RF is leveled or unleveled. With leveled operation range is 30 dB minimum. See RF Power Leveling for leveled operation characteristics.
7. External FM operation has full amplitude modulation capability. See Amplitude Modulation.

Figure 3-6. External FM Operation

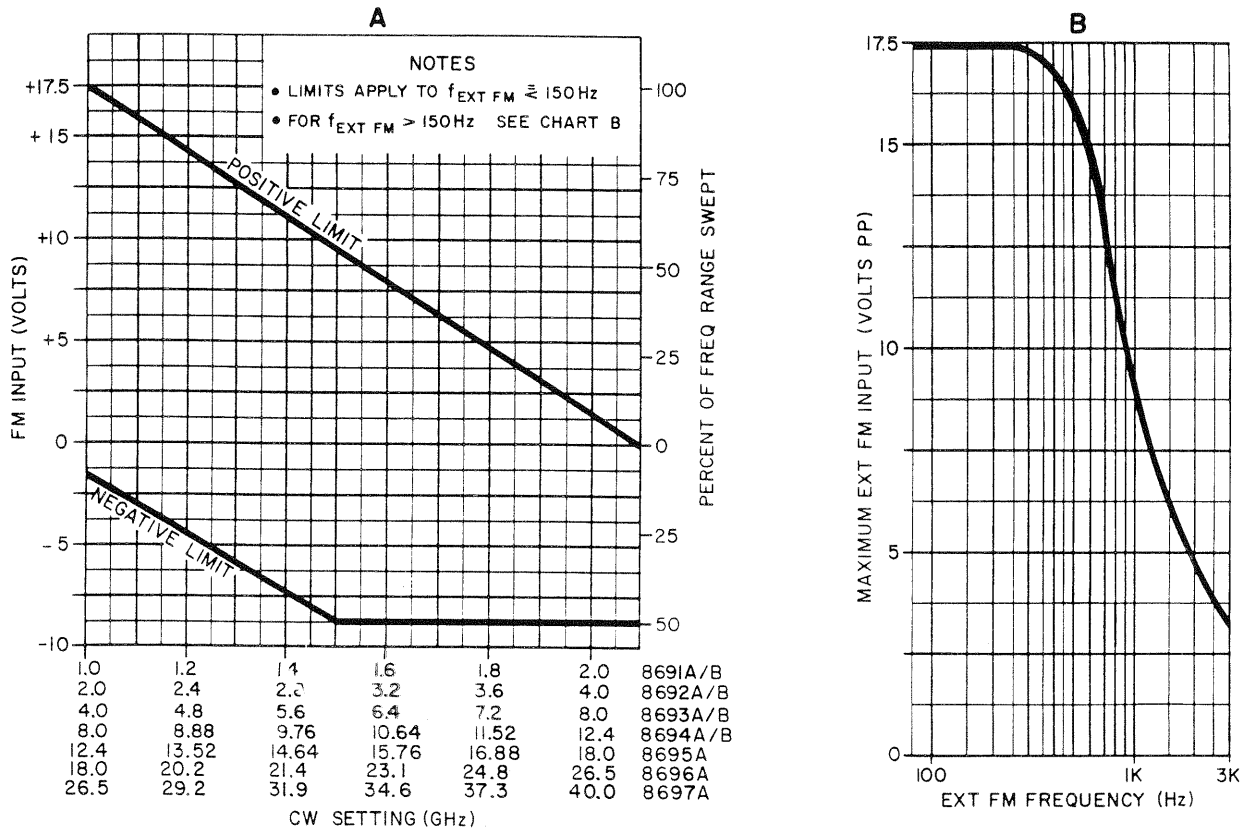

Figure 3-7. External FM Limitations

3-48. AUTO.

3-49. The AUTO sweep mode provides automatically recurrent sweeping for any sweep time selected by the SWEEP TIME controls and may be used with any sweep function except external FM. When the red SWEEP TIME vernier is in the detent LINE SYNC position, automatic sweeping is synchronized with the power-line frequency.

3-50. During AUTO sweeping the output frequency changes linearly with time and SWEEP light is on during each sweep.

3-51. Four sweep-synchronized outputs are activated during AUTO operation: SWEEP, SWEEP REF, BLANKING and PENLIFT. In addition, the RF output is automatically turned off, or blanked, between sweeps if the rear-panel BLANKING switch is ON.

3-52. TRIGGERED.

3-53. The triggered sweep mode permits manual one-shot sweeping and recurrent sweeping synchronized with an externally-produced signal, and may be used with any sweep function except external FM. A single sweep starts each time the front-panel MANUAL pushbutton is pressed and/or each time a suitable negative pulse is applied to the EXT input. Sweeping time is determined by the SWEEP TIME (SEC) controls but LINE SYNC is inoperative during triggered sweeping.

3-54. During a triggered sweep the output frequency changes linearly with time, and the SWEEP light is on.

3-55. Externally-produced trigger signals must have negative polarity, width greater than $1\ \mu\text{sec}$ and rise time of at least $0.1\ \text{volt}/\mu\text{sec}$. Less than 25 volts amplitude will trigger a sweep. During slow sweeps a sweep can be interrupted and reset by pressing the MANUAL pushbutton.

3-56. Four sweep-synchronized outputs are activated during TRIG operation: SWEEP, SWEEP REF, BLANKING and PENLIFT. In addition, the RF output is automatically turned off, or blanked, between sweeps if the rear-panel BLANKING switch is ON.

3-57. CW.

3-58. The CW mode gives single-frequency operation and may be used with either the start-stop or marker sweep functions. Output frequency can be set anywhere in the RF Unit frequency range. Obtain CW output as follows:

- a. Set LINE to RF.
- b. Set SWEEP SELECTOR to CW; on dial, CW lights.
- c. Press START-STOP or MARKER SWEEP.

d. Tune to desired frequency using START/CW or MARKER 1 as indicated by the sweep function selected.

e. Control output power with POWER LEVEL. For standard and Option 01 RF Units output power is maximum at 10, minimum at 0. POWER LEVEL is uncalibrated but has an attenuation range of at least 30 dB with unlevelled output, 10 dB with levelled output.

f. Internally square wave or externally amplitude modulate the RF output. See Amplitude Modulation.

g. Use automatic RF power leveling to stabilize output level and improve source match. See RF Power Leveling.

3-59. During CW operation RF blanking, PENLIFT, SWEEP, and SWEEP outputs are not operational. However, a voltage proportional to output frequency is available at the RF Unit rear-panel SWEEP REF OUTPUT.

3-60. MANUAL.

3-61. The manual sweep mode permits manual tuning between the end frequencies of the start-stop, marker, or ΔF sweep. Any of the amplitude modulation functions may be used with manual sweep, and RF output can be levelled or unlevelled. Both the SWEEP and SWEEP REF outputs are operational during manual sweeping, but RF blanking, PENLIFT and the SWEEP light do not function.

3-62. To sweep a frequency range manually, set controls for the desired sweep function using the appropriate instructions from Figures 3-3, 3-4, or 3-5 but set SWEEP SELECTOR to MANUAL and use MANUAL SWEEP to vary output frequency. Clockwise rotation varies output frequency toward the stop frequency of the selected sweep. Counterclockwise rotation varies output frequency toward the sweep start frequency. The SWEEP light does not function with manual sweeping.

3-63. Manual sweep is particularly useful for calibration of a display device such as an oscilloscope or graphic recorder prior to automatic swept-frequency measurements. Its use in this application is described in more detail under Displaying Swept-Frequency Measurements.

3-64. SWEEP TIME CONTROL.

3-65. The sweep time control consists of a four-position range selector and a vernier for continuous adjustment of sweeping time within the limits of each time range. Clockwise rotation of the vernier decreases sweeping time, the clockwise rotation limit giving the minimum time, and the counterclockwise limit giving the maximum time of the range selected. The detent LINE SYNC position of the vernier synchronizes sweeping with the power line frequency, but restricts sweeping time to the minimum of the range selected.

3-66. The sweep time controls are operational with start-stop, ΔF , and marker sweeps in the AUTO and TRIG modes. However, LINE SYNC does not function with triggered sweeps.

3-67. SWEEP OUTPUT.

3-68. SWEEP OUTPUT is an output frequency related positive voltage to provide a time or frequency axis for displaying swept frequency measurements. This positive voltage has fixed range, typically 0 to 15 volts, irrespective of sweep width. Zero is always coincident with the sweep start frequency and +15 volts is always coincident with the sweep stop frequency. With automatic and triggered sweeps, SWEEP OUT is a linear ramp synchronized with the RF sweep. During manual sweeps, SWEEP OUT voltage change is concurrent with output frequency change. SWEEP OUT functions with start-stop, marker, and ΔF sweeps in the AUTO, MANUAL and TRIG modes.

3-69. SWEEP REFERENCE OUTPUT.

3-70. The RF Unit rear-panel SWEEP REF OUTPUT is a direct-coupled positive voltage proportional to output frequency. SWEEP REF is 40 volts per octave and is determined by RF Unit A1R36 and A1R37 for the particular frequency range of the RF Unit used. Voltage change is concurrent with output frequency change, the actual range and dc limits being determined by the RF sweep width and its location in the frequency range. SWEEP REF OUTPUT is provided with all sweep functions and modes.

3-71. PENLIFT.

3-72. The rear-panel PENLIFT terminals furnish a sweep-synchronized writing control for graphic recorders equipped to write in response to a remote short circuit. The PENLIFT terminals are shorted during the RF sweep, open between sweeps. The PENLIFT circuit operates during AUTO and TRIG sweeps in the two slowest sweep time ranges only.

3-73. RF BLANKING.

3-74. The RF blanking automatically attenuates the power output at least 30 dB ("A" Model RF Units, 20 dB for "B" Models) between sweeps giving a no-output reference trace on an oscilloscope display of swept-frequency measurement. Blanking can be used with start-stop, marker, and ΔF sweeps in the AUTO and TRIG modes. With AUTO sweeps the blanking interval ends slightly in advance of RF sweep start to allow external circuits and equipment to stabilize. The RF blanking can be disabled with the rear-panel BLANKING On-Off switch.

3-75. During automatic and triggered sweeping a rectangular negative pulse coincident with the RF blanking is present at the rear-panel BLANKING OUTPUT. The pulse has 3.5 to 4 volts amplitude and is independent of the BLANKING ON-OFF switch setting.

3-76. EXPANDED SWEEP OPERATION.

3-77. Certain swept-frequency measurements, such as bandpass filter evaluation, require rapid examination of more than one frequency band (e.g., filter overall response characteristic, pass and stop bands).

3-78. Because the start-stop and marker sweeps are independent they can be used in combination with the internal frequency markers to obtain expanded sweep presentation. For instance, start-stop sweep can be used to cover a broad frequency range such as the overall response characteristic of the filter mentioned above. If a segment of this range (the stop band, for example) merits detailed examination, the internal frequency markers can be activated and tuned to bracket the important segment. Then, pressing MARKER SWEEP expands the bracketed segment to occupy the full presentation and full sweep time. Without further adjustment, the original sweep may be restored by pressing START-STOP.

3-79. The foregoing example of expanded sweep operation assumes one sweep range within another. However, the two sweep ranges need not be one within the other or even overlap; they may each cover separate, remote segments of the RF Unit frequency range.

3-80. FOUR PRESET CW FREQUENCIES.

3-81. The manual sweep control, in conjunction with the CW mode and the start-stop and marker sweep functions, can be used to obtain four preset CW frequencies as follows:

- a. Select four different frequencies using START/CW, STOP/ Δ F, MARKER 1, and MARKER 2 controls.
- b. Rotate MANUAL SWEEP fully clockwise.
- c. Set SWEEP SELECTOR to CW.
- d. Press START-STOP to obtain CW output at frequency indicated by START/CW dial pointer.
- e. Press MARKER SWEEP to obtain CW output at frequency indicated by MARKER 1 setting.
- f. Set SWEEP SELECTOR to MANUAL to obtain CW output at frequency indicated by MARKER 2 setting.
- g. Press START-STOP to obtain CW output at frequency indicated by STOP/ Δ F dial pointer.

3-82. AMPLITUDE MODULATION.

3-83. EXTERNAL AM.

3-84. The Sweep Oscillator RF output may be amplitude modulated by signals applied to the front-panel connector under the EXT AM pushbutton. External amplitude modulation is possible with any sweep mode or function. Frequency response is dc to 350 kHz for unleveled RF output and dc to 50 kHz for leveled output. Negative 10 volts reduces RF output at least 30 dB below rated CW output ("A" Model RF Units, 20 dB for "B" Models).

3-85. INTERNAL FREQUENCY MARKERS.

3-86. Two calibrated frequency markers can be independently adjusted over the full frequency range of the RF Unit. One is tuned by the MARKER 1 control and the other by the MARKER 2 control. Each marker amplitude-modulates the RF output with a wedge-shaped notch at the frequency indicated by the appropriate marker dial pointer. The front-panel MARKER AMP control permits amplitude adjustment of the amplitude-modulating marker but does not affect the amplitude of the pulses at the rear-panel MARKER OUTPUT. The amplitude of these pulses is typically -5 volts peak into a 1000-ohm load.

3-87. Activated separately by the MARK 1 and MARK 2 pushbuttons, the markers can be used individually or simultaneously during start-stop, Δ F, or external FM operation with the auto, manual, or triggered mode. In addition, markers may be used in combination with external amplitude or internal square-wave modulation.

3-88. INTERNAL SQUARE WAVE.

3-89. Internally-generated square-wave modulation can be used with any sweep function or sweep mode and with marker or external amplitude modulation. At rated RF output the square wave on-off ratio exceeds 20 dB. The INT SQ WAVE pushbutton selects square wave modulation, and INT SQ WAVE FREQ permits continuous adjustment of frequency from 950 to 1050 Hz.

3-90. RF POWER LEVELING.

3-91. A requirement for rapid, broadband evaluation of microwave devices is constant RF power in the frequency range of interest. The backward-wave oscillator (BWO) used as the microwave source in the RF Unit does not generate constant RF power throughout the operating frequency range. The RF power output of a BWO usually consists of minor, narrowband variations superimposed on a gross variation, as illustrated in Figure 3-8. Minor variations are typically less than 3 dB while the gross variation may be as great as 10 dB. By deriving a signal which is the inverse of this power characteristic and applying it as amplitude control, the RF power output can be maintained essentially constant with changing frequency. This control of output power is called leveling.

3-92. The leveling system in the 8690B Sweep Oscillator-8690 series RF Units is a negative feedback closed loop. The system senses RF power variations and automatically produced amplitude-control signals which reduce power variations.

3-93. A typical negative feedback closed leveling loop (Figure 3-9) consists of a directional coupler to sample RF output, a crystal detector to convert instantaneous RF power variations in the sample to proportional dc, and a differential amplifier to compare the dc against a reference and furnish an amplified difference signal. This difference signal, applied as RF amplitude control, determines magnitude of leveled power and reduces power variations.

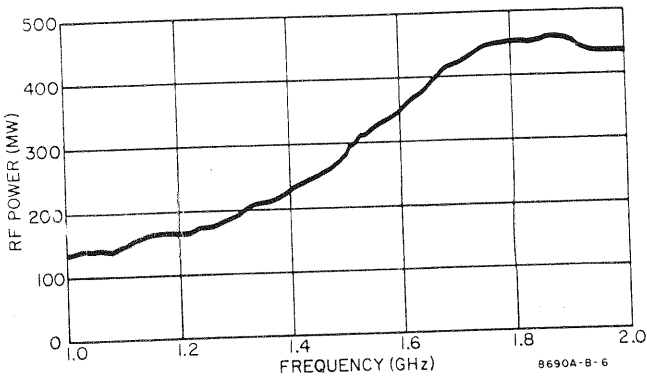
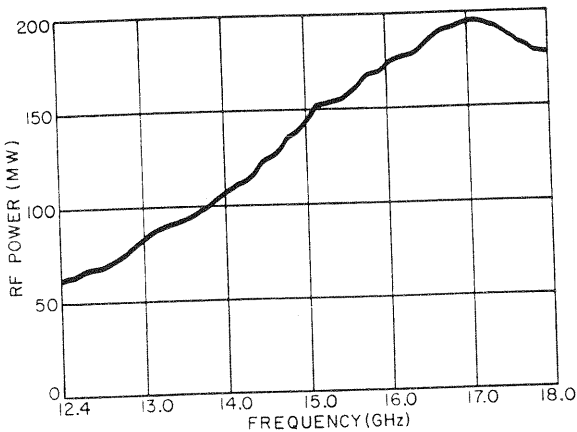

Figure 3-8. Typical RF Power Output Characteristics of 1-2 GHz and 12.4-18GHz BWO Tubes

3-94. In the leveling loop the differential amplifier acts to keep the input from the crystal detector equal to the dc reference and, by feedback action, causes the leveling loop to maintain crystal detector output constant. The same feedback action would also maintain RF power in the coupler main line constant, but between the detector output and the coupler main line are several frequency-dependent variables which prevent main line power from being absolutely constant. Such factors as detector frequency response, coupling variation with frequency, coupler-to-detector match, and coupler directivity each affect the flatness of RF power in the coupler main line. Nevertheless, the leveling loop can reduce power variations from a deviation as great as 10 dB to less than 1 dB over the RF Unit tuning range.

3-95. In addition to holding RF power constant with changing frequency, the leveling loop also improves source match. The amount of improvement is determined by the directivity and main-line SWR of the RF-sampling directional coupler: the greater the directivity and the smaller the main-line SWR, the greater the source match improvement. The practical limit to the effect of directivity, however, is usually the coupler main-line SWR. For coaxial couplers having main-line SWR of 1.2:1, for instance, directivity exceeding 26 to 30 dB produces no significant source match improvement. Similarly, for a waveguide coupler having main-

line SWR of 1.05:1 the practical directivity limit is about 40 dB.

3-96. LEVELING POINT CONSIDERATIONS.

3-97. The closed leveling loop holds RF power constant at the point of RF sampling. Thus, if sampling is done at the RF Unit power output connector, discontinuities in the transmission system between the connector and load cause uncontrollable power variations at the load. However, if the sampling point is located as near the load as possible, transmission system discontinuities are contained within the leveling loop and their effects are automatically compensated.

3-98. The effect of leveling point location on power variations at the load is shown in Figure 3-10. Although X-Y recorder plot A was obtained with the coupler-detector external to the Sweep Oscillator, the plot is also valid for Option 01 RF Units which have an internal directional detector. Although the plots were made using a 1-2 GHz BWO, this comparison is typical for all RF Unit frequency ranges.

3-99. Recorder plot A was made with a HP 360 Low-Pass Filter (arrow, Figure 3-10) connected between the sampling coupler and load to simulate transmission irregularity between leveling loop and load. The filter has maximum SWR of 1.4:1 and the load, consisting of a 50-ohm termination and HP 478 Thermistor Mount, has an SWR of about 2:1. The resultant power variation in the frequency range swept is approximately 1 dB. In contrast, recorder plot B shows power variation at the load reduced to 0.25 dB with the leveling point at the load.

3-100. Remote-point leveling is accomplished using the same systems and procedures as those given in succeeding paragraphs for leveling at the RF output, the only difference being that the RF-sampling directional detector or directional coupler and RF detector are located at the system point where leveled RF power is required, not at the RF Unit power output connector.

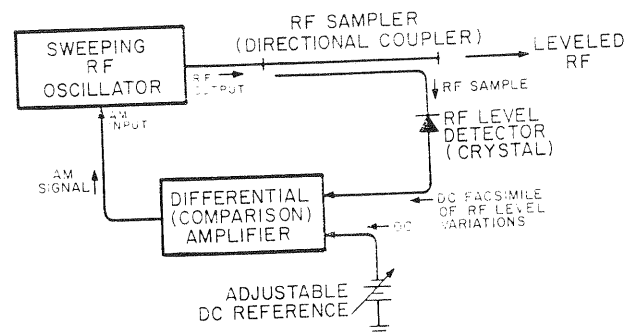

Figure 3-9. Typical Leveling Loop

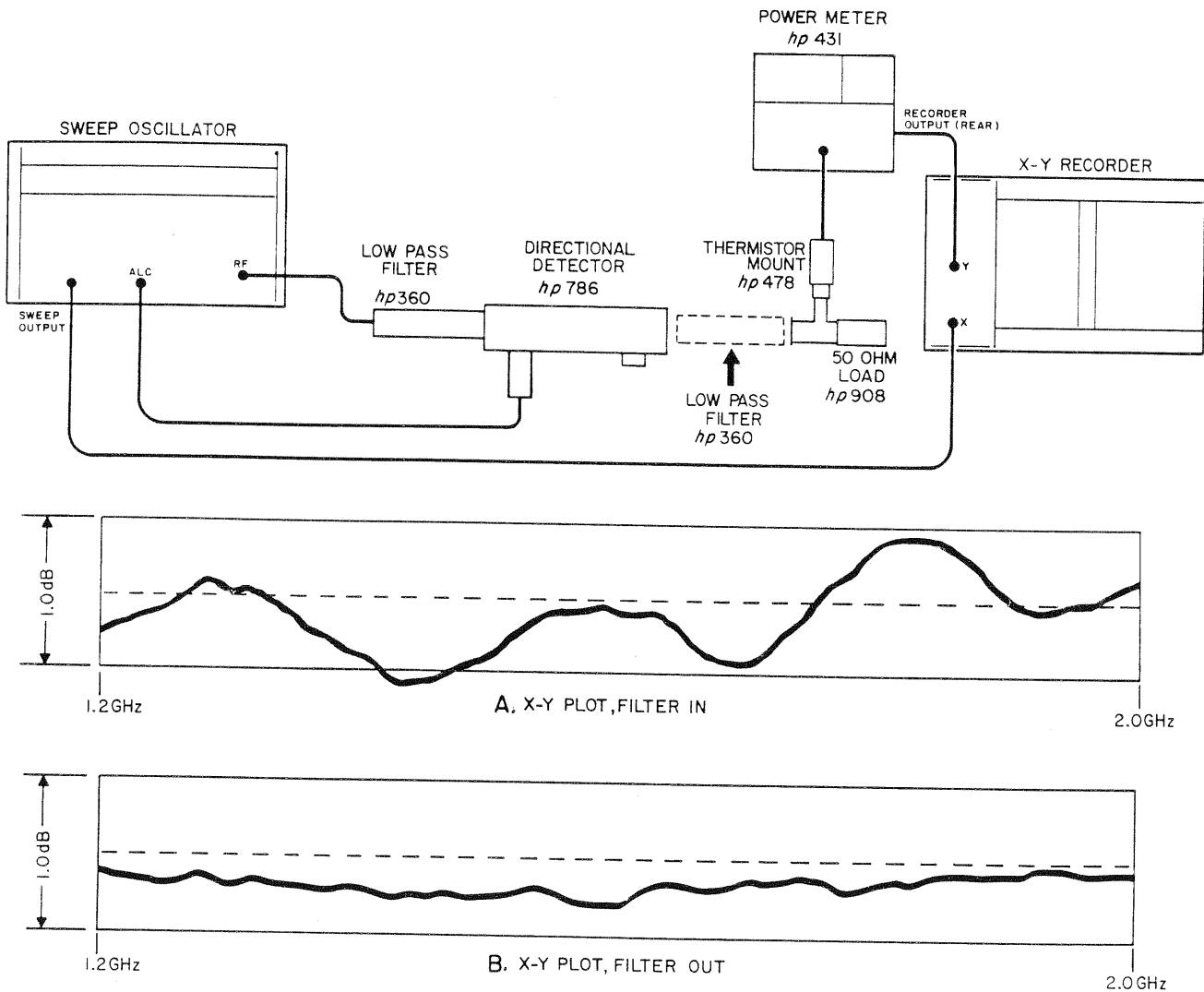

Figure 3-10. Effect of Leveling Point on Power Variation

3-101. DEPENDENCY OF MAXIMUM LEVELLED POWER ON FREQUENCY.

3-102. Maximum leveled RF power cannot exceed the minimum available from the BWO in the frequency range being swept. Also, the maximum leveled RF power available from a particular Sweep Oscillator depends upon the frequency range being swept and the output power characteristic of the microwave oscillator (BWO) in the RF Unit used. Figure 3-11 shows the output power characteristics of a typical 1 to 2 GHz and 12.4 to 18 GHz oscillators. The Figure indicates the maximum leveled RF power available for three sweep ranges within each frequency range. Dot shading indicates maximum leveled power available over a full frequency range; diagonal shading shows additional leveled power available in segments of the frequency range. Microwave oscillators in the frequency ranges 2 to 12.4 GHz and 18 to 40 GHz have similar output power characteristics; that is, RF output is minimum toward the lower frequency limit of the tuning range and increases with frequency to a maximum at, or near, the upper limit of the tuning range. However,

actual maximum and minimum RF power available varies from frequency range to frequency range and from BWO to BWO in the same frequency range. Therefore, a microwave power meter such as the HP Model 431 with an appropriate thermistor mount is required both for determining maximum leveled RF power and for obtaining required RF power.

3-103. LEVELING EQUIPMENT.

3-104. The leveling amplifier in the Sweep Oscillator-RF Unit combination is intended for use with HP 423 and 424 Crystal Detectors, HP directional detectors, HP directional couplers. Since these components are available in both coaxial and waveguide models, RF leveling is possible in either transmission system. Components for coaxial RF leveling systems and waveguide leveling systems are listed in Table 1-2.

3-105. THE RF SAMPLER. The RF power output can be sampled either by a directional coupler or a directional detector. A directional detector is a direc-

Model 8690B

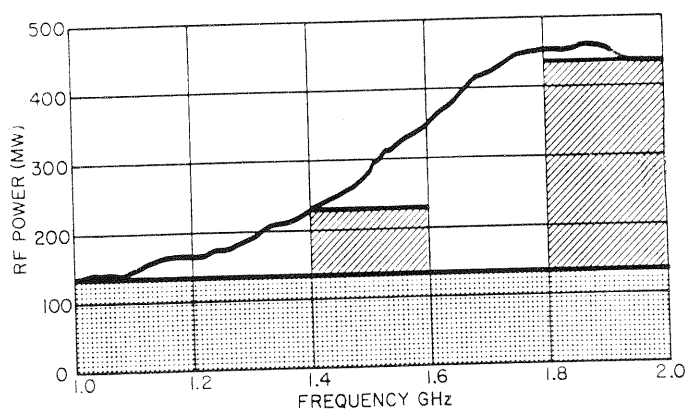
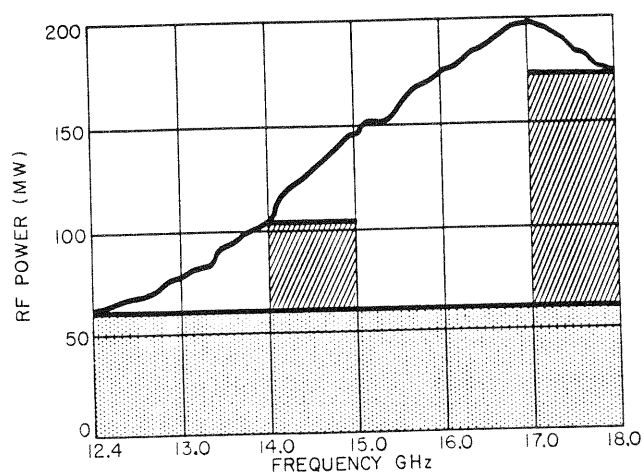

Figure 3-11. Comparison of Maximum Leveled RF Power and Frequency Range Swept

tional coupler matched to a sensitive, flat-responding crystal detector. With the directional detector, performance variables such as coupling variation with frequency, detector frequency response, and coupler-detector match are grouped and specified as frequency response.

3-106. Whether the RF sampler is a directional coupler or directional detector there is a critical coupling attenuation required to assure proper operation of the leveling loop. Coupling attenuation should be 20 to 23 dB with the Models 8691A/B, through 8694A/B, and 8695A, 10 to 13 dB with the Models 8696A and 8697A. In addition, the smaller the coupling variation with frequency and the greater the directivity, the better the leveling.

3-107. THE RF DETECTOR. A crystal detector may be used to derive the dc signal proportional to RF power variations required to operate the leveling amplifier, which must receive a negative polarity signal, is intended for use with HP 423 and 424 Crystal Detectors, and HP directional detectors.

3-108. A crystal detector permits use of the full sweep time range of the Sweep Oscillator. Thus, sweeping

time can be short enough to give steady oscilloscope display of swept-frequency measurements, a capability especially useful for continuous display of the effects of tuning or adjusting a device under test.

3-110. LOW-PASS OR BANDPASS FILTER. To minimize the effects of RF harmonics, which can degrade leveling and cause measurement errors, a low-pass or bandpass filter should be inserted into the RF main line within the leveling loop. Including the filter in the leveling loop provides automatic compensation for its transmission properties.

3-111. OSCILLOSCOPE MONITOR. For RF power leveling using a crystal detector, an oscilloscope should be used to indicate when the RF Unit POWER LEVEL and EXT ALC GAIN controls are set to give optimum leveling. If an oscilloscope is used to display the results of swept-frequency measurements, it can serve to monitor leveling performance as well. If no such display is used, the monitor oscilloscope should be connected between the RF detector and the Sweep Oscillator. For standard RF Units, loop performance can be monitored by means of a type BNC tee connector at the crystal detector video output or at the Sweep Oscillator XTAL input.

3-112. LEVELING PERFORMANCE.

3-113. For proper leveling without ALC loop oscillations, the ALC voltage returned to the 8690B XTAL input must be 100 mV or less. To ensure this requirement, always maintain an open loop ALC voltage of 50 mV or less. For RF detectors such as the HP Model 423, with a square law load, this voltage will not be exceeded if the input power to the RF detector is held to 1 mW or less.

3-114. When a traveling wave tube (TWT) amplifier is used, leveling signals should be applied to the 8690B. A low pass filter should be connected to the output of the TWT and an isolator connected to the input of a directional coupler. Directional Couplers should be used to provide RF input to the RF detector, rather than to use a directional detector. The directional coupler permits insertion of additional attenuation if required to hold the power at the detector to 1 mW or less.

3-115. The RF power leveling capability of the systems illustrated in Figures 3-12 through 3-17 is determined mainly by the frequency-dependent performance variables of the RF sampler and RF detector. Coupling variation with frequency, coupler-to-detector mismatch, coupler directivity and detector frequency response all affect leveling. The level variations given in Tables 3-1 and 3-2 are those resulting from the maximum effect of the error sources present in leveling loops assembled from appropriate components

Table 3-1. Leveling Performance of Coaxial Leveling Loops

Leveling Loop	Maximum Power Variation (dB) ¹							
	Load SWR = 1				Load SWR = 1.5			
	1-2 GHz	2-4 GHz	4-8 GHz	8-12.4 GHz	1-2 GHz	2-4 GHz	4-8 GHz	8-12.4 GHz
Figure 3-12 with Coupler and Detector	±0.66	±0.68	±0.72		±0.82	±0.88	±0.92	
Figure 3-12 with Directional Detector	±0.40	±0.40	±0.40	±0.60	±0.56	±0.60	±0.60	±0.80

¹ Worst case: Errors summed arithmetically (see Paragraph 3-115).

Table 3-2. Leveling Performance of Waveguide Leveling Loops

Leveling Loop	Maximum Power Variation (dB) ¹									
	Load SWR = 1					Load SWR = 1.5				
	2.60-3.95 GHz	3.95-5.85 GHz	5.85-8.2 GHz	7.05-10.0 GHz	8.2-12.4 GHz	2.60-3.95 GHz	3.95-5.85 GHz	5.85-8.2 GHz	7.05-10.0 GHz	8.2-12.4 GHz
Fig. 3-13 with Coupler and Detector	±0.95	±0.95	±0.94	±0.94	±1.04	±0.98	±0.98	±0.98	±0.98	±1.08
Fig. 3-13 with Directional Detector					±0.60					±0.64
Fig. 3-14	±0.64	±0.64	±0.64	±0.64	±0.74	±0.68	±0.68	±0.68	±0.68	±0.78

¹ Worst case: Errors summed arithmetically (see Paragraph 3-115).

listed in Table 1-2. However, the error effects in such leveling systems are vector quantities having phase relationships which vary with frequency and do not always cause maximum error. Rather, total error is more usually the rms of the error quantities. Therefore, leveling likely will be better than indicated, but the performance figures given permit comparing the capabilities of the systems illustrated in Figures 3-12 through 3-14.

3-116. Two values of load SWR are included in the tables to indicate how the load on the leveling system influences leveling performance. This loading effect results from the imperfect directivity of the RF-sampling coupler which allows some of the power reflected from the load to reach the RF detector and cause level variations. For a given coupler, load-produced level variation is proportional to load SWR.

3-117. LEVELING CONTROLS, INDICATORS AND INPUTS.

3-118. ALC PUSHBUTTON. The ALC pushbutton activates the internal leveling amplifier.

3-119. ALC SWITCH. On Option 001 RF Units only, the rear panel ALC switch activates an internal leveling system.

3-120. POWER LEVEL CONTROL. The two-section RF Unit POWER LEVEL control sets magnitude of leveled RF power.

3-121. EXT ALC GAIN CONTROL. This rear panel RF Unit control varies leveling loop sensitivity to RF level variations.

3-122. LEVELING SIGNAL INPUTS. The front-panel XTAL input accepts crystal detector-derived leveling signals.

3-123. POWER LEVEL INDICATOR. The UNLEVELED indicator functions only when the ALC pushbutton is pressed (rear panel RF Unit ALC switch is set to INT). When the UNLEVELED light is off, the entire sweep is leveled; when on, all or part of sweep is unleveled.

Model 8690B

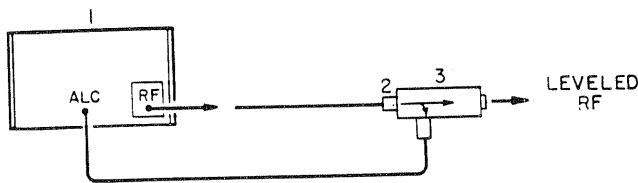

1. SWEEP OSCILLATOR
2. LOW PASS OR BANDPASS FILTER
3. DIRECTIONAL COUPLER AND CRYSTAL DETECTOR OR DIRECTIONAL DETECTOR

Figure 3-12. Coaxial Leveling Loop Using Crystal Detector

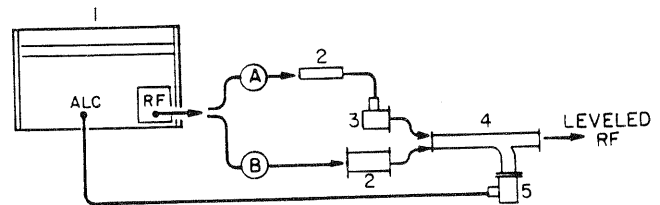

1. SWEEP OSCILLATOR
2. LOW PASS OR BANDPASS FILTER
3. WAVEGUIDE TO COAXIAL OUTPUT
4. DIRECTIONAL COUPLER
5. CRYSTAL DETECTOR

- (A) FOR COAXIAL OUTPUT RF UNITS
(B) FOR WAVEGUIDE OUTPUT RF UNITS

Figure 3-13. Waveguide Leveling Loop Using Crystal Detector

3-124. In general, the RF Unit EXT ALC GAIN control determines the ability of the leveling system to reduce RF power variations and POWER LEVEL controls the magnitude of leveled power. Thus, EXT ALC GAIN can be considered an RF flatness control and POWER LEVEL an RF amplitude control. RF Unit Models 8691A thru 8697A have enough function overlap between EXT ALC GAIN and POWER LEVEL that the settings of both controls must be optimized during initial leveling adjustments and thereafter whenever RF amplitude is changed. Clockwise rotation of EXT ALC GAIN improves RF flatness but can cause the leveling loop to oscillate; hence, the optimum EXT ALC GAIN setting is just counterclockwise of that which causes loop oscillation.

3-125. LEVELING AT THE RF OUTPUT.

3-126. Figures 3-12 through 3-14 illustrate closed loop leveling systems for automatically leveling the RF power output. The systems of Figures 3-14 and 3-17 each use two directional couplers to minimize coupling variation with frequency. The coupling variation of one coupler compensates for the coupling variation of the other, reducing coupling inaccuracy to the difference in coupling characteristics between the couplers. This remaining factor can be effectively eliminated with couplers selected for nearly identical coupling characteristics. Such matched couplers are available from Hewlett-Packard in various combinations of coupling attenuation. For each combination, attenuation accuracy between main and secondary line output is specified and is typically ± 0.2 dB or better.

3-127. STANDARD SWEEP OSCILLATOR USING CRYSTAL DETECTOR.

3-128. LOOP ASSEMBLY.

- a. Assemble the leveling loop of Figure 3-12, 3-13, or 3-14 using appropriate equipment listed in Table 1-2.
- b. Connect crystal detector video output to Sweep Oscillator XTAL input.

c. Connect an oscilloscope to monitor leveling loop performance. Connect the oscilloscope vertical input (dc-coupled) to a BNC tee connector at the crystal detector video output, and connect the horizontal input (dc-coupled) to the Sweep Oscillator SWEEP OUT.

3-129. LOOP OPERATION.

- a. Obtain desired mode of operation from the Sweep Oscillator.
- b. Adjust EXT ALC GAIN maximum clockwise. (Rear panel, RF Unit.)
- c. Press ALC.
- d. Rotate POWER LEVEL knob to a convenient reference on the 0 to 10 scale. (For maximum resolution set to 10.)
- e. If POWER LEVEL is set for more RF power than the least available in the selected sweep range, the UNLEVELED light will light. To level the entire sweep, rotate POWER LEVEL until the UNLEVELED light goes out. Leveled RF power is now the maximum available in the selected frequency range.
- f. If an oscilloscope monitoring ALC loop performance shows loop oscillation, adjust RF Unit rear panel EXT ALC GAIN until oscillation just ceases. Always adjust RF Unit EXT ALC GAIN and LEVEL SHUNT/POWER LEVEL controls in combination to ensure maximum leveled RF power without loop oscillation.

Note

To change power level control resolution, remove the top cover of the sweep oscillator and set screwdriver operated RF Unit A1R1 LEVEL SHUNT until the UNLEVELED light goes out.

g. To reduce leveled RF power rotate POWER LEVEL knob counterclockwise; attenuation range is 10 dB, minimum. When using RF Unit Models 8691A thru 8697A, readjust EXT ALC GAIN after each change of power level.

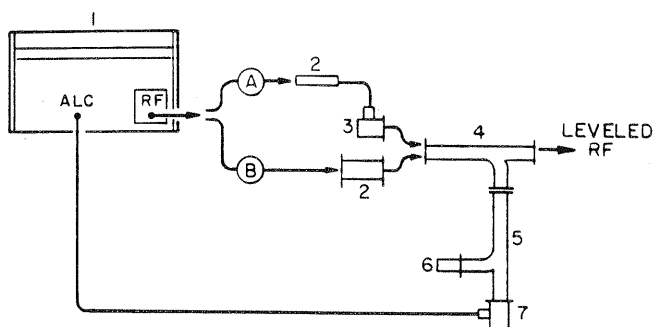

1. SWEEP OSCILLATOR
2. LOW PASS OR BANDPASS FILTER
3. WAVEGUIDE TO COAXIAL ADAPTER
4. & 5. MATCHED DIRECTIONAL COUPLERS
6. LOAD
7. CRYSTAL DETECTOR

- (A) FOR COAXIAL OUTPUT RF UNIT
(B) FOR WAVEGUIDE OUTPUT RF UNIT

Figure 3-14. Coupler-Compensated Waveguide Leveling Loop Using Crystal Detector

3-130. OPTION 001 RF UNITS.

3-131. LOOP ASSEMBLY.

3-132. Option 001 RF Units, having internal leveling loops, require no external equipment to furnish leveled RF power. However, Option 001 RF Units do require a power meter to indicate actual leveled power, and an oscilloscope to indicate optimum leveling. Note: the rear panel ALC switch must be at INT to activate the internal leveling loop. In the EXT position, the loop is disabled.

3-133. LOOP OPERATION.

a. Set Sweep Oscillator for desired mode of operation.

b. Set ALC switch to INT.

c. If POWER LEVEL is set for more RF power than the least available in the frequency range being swept, the UNLEVELED light will light. Rotate POWER LEVEL counterclockwise until UNLEVELED light remains off during the sweep interval. Output power is now leveled at maximum possible in the selected frequency range.

3-134. EXT ALC GAIN ADJUSTMENT.

3-135. Gain of the leveling loop is affected by the directional coupler used. The EXT ALC GAIN adjustment on the RF Unit rear panel permits operator adjustment of ALC loop gain.

3-136. Proper ALC gain adjustment is obtained by observing an oscilloscope display of the leveled RF output. With 8690B square wave modulation on, adjust EXT ALC GAIN for optimum leveled display without square wave overshoot as shown in Figure 3-15.

3-137. DISPLAYING SWEEP-FREQUENCY MEASUREMENTS.

3-138. OSCILLOSCOPE DISPLAY.

3-139. The use of an oscilloscope in conjunction with a sensitive, fast-responding detector such as a crystal permits continuous visual display of swept-frequency measurements, a capability which is especially useful if a device is to be adjusted while under test.

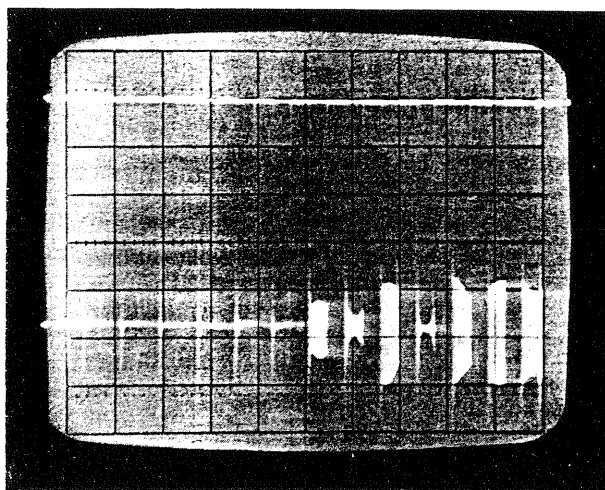

Incorrect

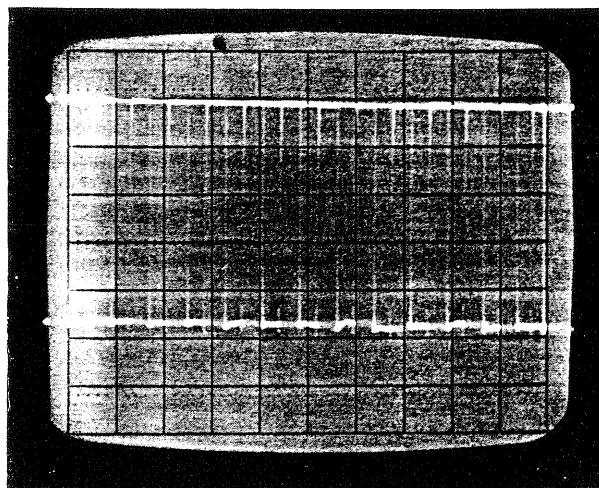

Correct

Figure 3-15. Example Oscilloscope Displays of Correct and Incorrect EXT ALC GAIN Adjustment

3-140. For oscilloscope display the Sweep Oscillator SWEEP OUT furnishes the horizontal deflection signal. Since SWEEP OUT is a linear sawtooth voltage synchronized with the sweep, it provides an accurate axis of frequency for the display. In addition, automatic blanking of the RF output during retrace results in a continuous zero-power reference trace for the display.

3-141. The display oscilloscope should have direct-coupled vertical and horizontal inputs and 10 kHz minimum vertical bandwidth. Reflection measurements can require vertical sensitivity of microvolts per centimeter: 50 to 100 $\mu\text{V}/\text{cm}$ is usually adequate. The HP 140 Oscilloscope with 1400 and 1420 horizontal plug-ins satisfies these requirements.

3-142. Detailed information about improved measurement systems and calibration techniques for transmission studies using the Sweep Oscillator is available in HP Application Note 65, Swept-Frequency Techniques. The Note contains: procedures for assembling, calibrating, and operating systems for transmission and reflection measurements using leveled HP Sweep Oscillators; instructions for using the HP 1416 Swept Frequency Indicator oscilloscope plug-in to display measurements directly in dB; and a list of measuring equipment for the 1 to 40 GHz frequency range. The Note also contains a set of scales calibrated in reflection and transmission units which can be affixed to the graticule of a conventional oscilloscope to adapt it to swept-frequency measurements. Copies of Application Note 65 are available at no charge from your local Hewlett-Packard sales and service office.

3-143. X-Y RECORDER DISPLAY.

3-144. The X-Y graphic recorder affords a convenient means of permanently recording swept-frequency measurements, providing a plot of transmission variations with time or frequency. To facilitate X-Y recording, the Sweep Oscillator has manual sweep for recorder calibration; a linear ramp voltage output synchronized with output frequency to operate the recorder X-system; indication of sweep duration for positive determination of sweep start and stop; internally-generated, tunable frequency markers for accurate calibration of frequency range; and automatic penlift to raise the recorder pen between sweeps.

3-145. Penlift is intended for recorders equipped to raise the pen in response to an open circuit. The Sweep Oscillator rear-panel PENLIFT terminals are open-circuited in the interval between sweeps during CW and triggered sweep operation with either of the two slowest sweep time ranges.

3-146. RECORDER CALIBRATION.

3-147. Figure 3-16 shows a setup for X-Y plotting of the output power-frequency characteristic of the Sweep

Oscillator. Other swept-frequency measurements for which the recorder is a popular display device include SWR, attenuation, gain, directivity, and leveling performance.

3-148. Calibrate the recorder as follows:

- a. Set the Sweep Oscillator to sweep the frequency range of interest using a sweep time compatible with recorder response.
- b. Set SWEEP SELECTOR to MANUAL.
- c. Rotate MANUAL SWEEP maximum counterclockwise (for CW output at sweep start frequency), and adjust recorder Y-zero for convenient pen position.
- d. Adjust recorder X-system to locate pen at a convenient start point.
- e. Rotate MANUAL SWEEP from full counterclockwise to full clockwise (for CW output at sweep stop frequency) observing maximum vertical displacement of the pen during the sweep.
- f. Set recorder X-sensitivity to terminate recorder pen traverse at a convenient location on the chart, and adjust Y-sensitivity to give required resolution.
- g. If sensitivity and zero of the recorder X and Y systems are interdependent, repeat steps d through f to ensure desired chart calibration.
- h. Set SWEEP SELECTOR to TRIG. For one-shot sweeps, set SWEEP SELECTOR to TRIG and press MANUAL TRIGGER to start sweep. (A sweep can be terminated and restarted by pressing MANUAL TRIGGER.) The recorder pen lifts automatically during retrace if the recorder is equipped for pen lift in response to an open circuit.

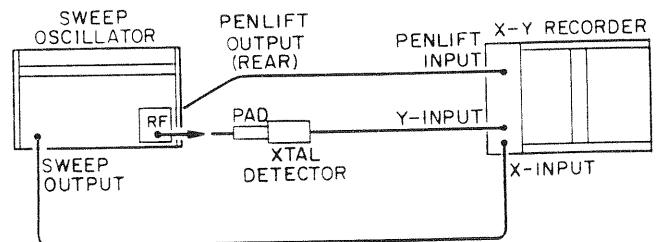

Figure 3-16. Typical X-Y Recorder Setup to Plot Sweep Oscillator Power Output Characteristic

SECTION IV

PRINCIPLES OF OPERATION

4-1. INTRODUCTION.

4-2. This section contains explanations of the operation of the Sweep Oscillator and RF Unit circuits. Figure 4-1 is a simplified block diagram showing principal circuit sections and operating controls. Figure 4-2, a more complete block diagram, shows the main constituents of the circuit sections. Each circuit section and important individual circuits are explained in succeeding paragraphs.

4-3. As illustrated in Figure 4-2, the Sweep Oscillator consists of the RF Unit, a Frequency Control Section, an Amplitude Modulation Section, an Automatic Level Control Amplifier and a Power Supply Section. The RF Unit contains ALC gain, sweep reference output, anode supply and unlevelled lamp circuits in addition to the Backward Wave Oscillator and a frequency shape circuit. The "A" series RF Units contain a grid modulator circuit. In the "B" series RF Units the grid modulator circuit function is replaced by a PIN Modulator (solid-state attenuator-modulator). In addition, Option 01 RF Units contain a directional detector. The Frequency Control Section includes the frequency-modulating circuits. The Amplitude Modulation Section includes a square-wave generator, two marker generators, and a blanking switch. The Power Supply Section includes automatic over-current and over-voltage protection for the Voltage-Tuned Oscillator.

4-4. THE BACKWARD-WAVE OSCILLATOR TUBE.

4-5. The Backward-Wave Oscillator (BWO) tube, a voltage-tunable microwave oscillator, is the radio-frequency source in the Sweep Oscillator.

4-6. The BWO tube is an electron tube in which an electron beam interacts with a guided electromagnetic wave in a way to transfer energy from the beam to the wave. The elements of the tube and their arrangement are shown in Figure 4-3. The tube consists of an electron gun, a wire helix through which an electron beam is directed, and a collector to receive the beam, all within a vacuum tube. The electron beam is hollow and focused to travel as close as possible to the helix without touching it. Beam focus is maintained by the field of a cylindrical permanent magnet encircling the vacuum tube. The magnet or its housing completely covers the tube and cannot be removed or adjusted. Operating potentials are supplied to the tube elements through flexible leads.

4-7. The wire helix is a microwave transmission line equal in length to several wavelengths of the lowest output frequency. The RF output signal is generated on the helix and is coupled out of the tube at the gun end through a dc blocking capacitor or balun. Approximate potentials required to operate the BWO are

shown in Figure 4-3. Typical cathode current is less than 30 milliamperes and divides between anode and helix in BWO tubes having no collector, or between helix and collector in BWO tubes having a collector. Helix and anode operating currents are critical operating parameters and must not exceed the power dissipating capability of the element. Operating current maximums for the anode and helix are specified on the data sheet accompanying each new BWO tube. Because of wide variations in optimum operating currents and current division among BWO tubes of the same type, RF power output is the primary indicator of tube performance.

4-8. As the BWO is turned on, oscillation evolves from shot noise in the electron beam. The shot noise in the beam induces noise voltages on the helix, and the noise voltages on the helix produce electron bunches in the beam. These electron bunches move toward the collector at a velocity controlled by accelerating potentials. As the electron bunches pass the spaces between helix turns their electric fields appear outside the helix. At some frequency these electric fields are in step (resonate) with the electron bunches along the helix and a backward-moving wave is generated. The backward wave further bunches the beam, the beam in turn amplifies the backward wave, and so on, until a maximum bunch density is reached. At this state the backward wave has maximum amplitude for the existing operating conditions.

4-9. Frequency of oscillation, a function of beam velocity, is set by the accelerating electrode which has the same potential as the helix. Frequency of oscillation varies linearly with time as helix voltage varies exponentially with time: the more positive the voltage, the higher the frequency of oscillation. In the Sweep Oscillator, the frequency-changing voltage is applied to both the helix and collector. In some BWO tubes the helix and collector are connected internally; in others, the collector element is operated at a more positive potential than the helix.

4-10. Output RF power is a function of beam current: the greater the beam current, the greater the output power with maximum beam current determined by the power dissipating capacity of the helix and anode. Beam current is controlled both by grid bias and anode voltage. Anode voltage, however, influences frequency of oscillation as well as beam current. The RF output of the BWO tube in the A model RF Units is amplitude modulated by a grid modulator circuit. The circuit controls beam current without appreciably changing the accelerating anode cathode voltage, thereby maintaining frequency stability during amplitude modulation. BWO tubes in B model RF Units are operated with zero grid bias, beam current being controlled by anode voltage.

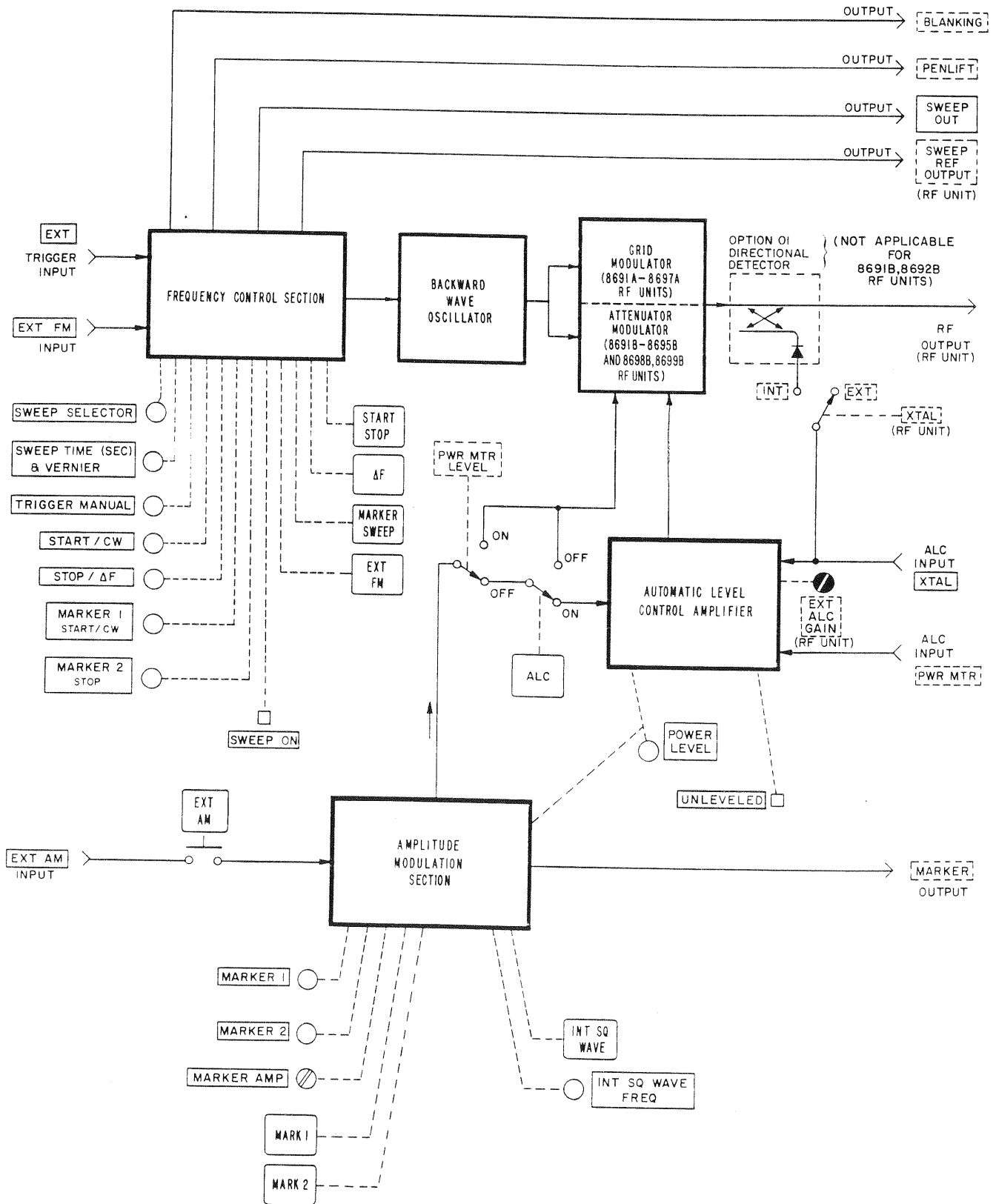

Figure 4-1. Simplified Block Diagram

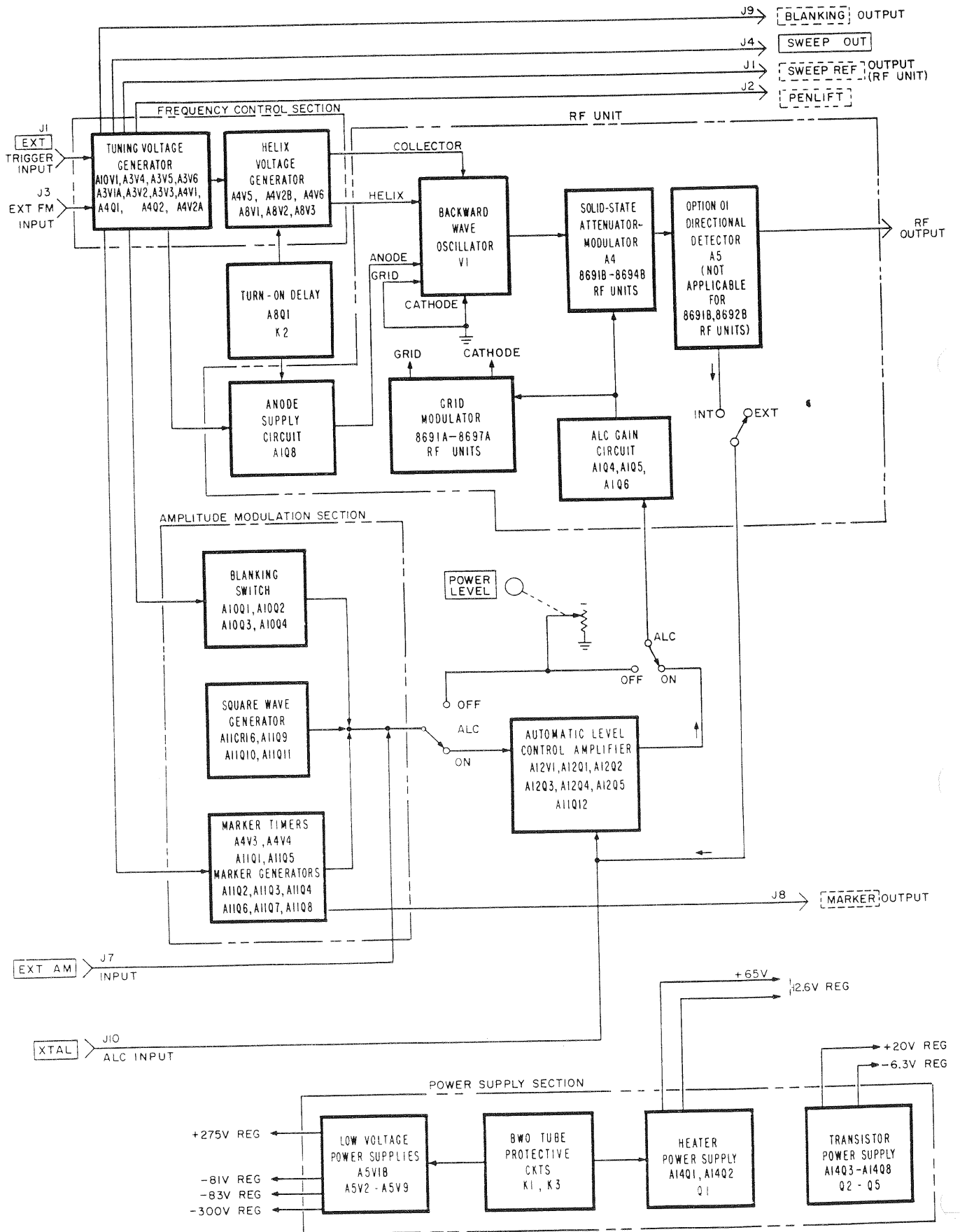

Figure 4-2. Block Diagram Showing Section Constituents

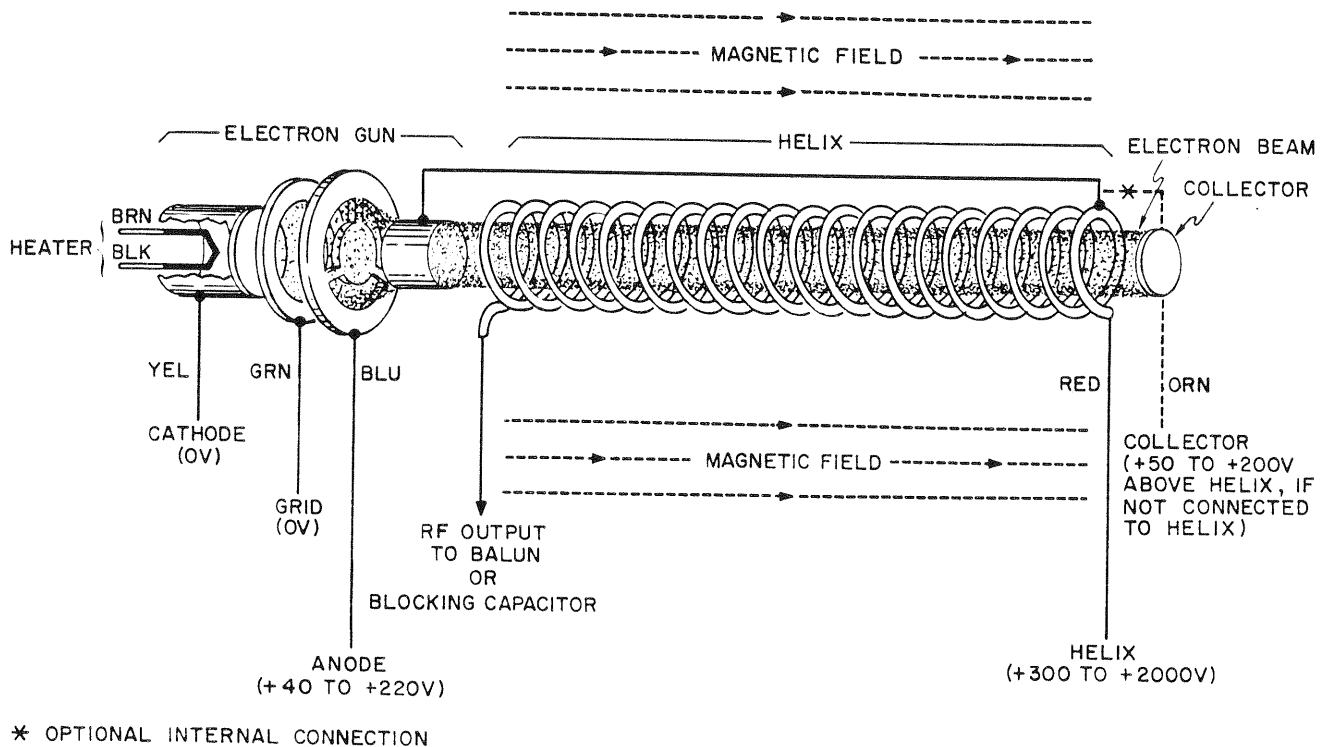

Figure 4-3. The Backward-Wave Oscillator Tube

4-11. THE FREQUENCY CONTROL SECTION.

4-12. The Frequency Control Section determines the Sweep Oscillator output frequency. It generates a ramp that sweeps the RF output, or a dc voltage that produces single-frequency output, or a combination ramp and dc voltage for narrowband sweeps, or a combination of a dc voltage and an external signal to give external frequency modulation. The section also produces automatically repetitive or triggered sweeps, and permits manual sweeping as well as individual tuning of the frequency markers.

4-13. The Frequency Control Section consists of a Tuning Voltage Generator and a Helix Voltage Generator. The Tuning Voltage Generator (Figure 4-4) consists of a Ramp Generator that generates a linear, negative-going ramp voltage, a Reciprocal Amplifier that produces a mirror-image positive-going ramp voltage, and a Ramp Combining Circuit that combines the two ramps and produces either a positive or negative-going ramp continuously adjustable in amplitude that is supplied to the Helix Voltage Generator for application to the BWO helix. This adjustable ramp controls the output frequency of the Backward Wave Oscillator, and can be monitored at the SWEEP REF output connector on the RF Unit for testing purposes. The approximate ramp voltage vs output frequency is approximately 40 volts per octave.

4-14. When CW operation is selected, the adjustable ramp is replaced by an adjustable dc voltage. When ΔF is selected, a small, adjustable ramp is super-

imposed on the CW dc voltage. When external FM is selected, the external signal is superimposed on the CW dc voltage.

4-15. The Frequency Control Section also supplies a positive-going sweep voltage for operating the X-system of graphic recorders and oscilloscopes, a penlift contact for lifting the pen of a recorder between sweeps, and a blanking pulse that cuts off RF output between sweeps.

4-16. THE RAMP GENERATOR.

4-17. GENERAL. The complete Ramp Generator (Figure 4-4) consists of Ramp Generator tube A10V1, Cathode Follower A3V2B with ramp limiting diodes A3CR41, A3CR42, and A3CR43. The ramp generator tube produces a linear, negative-going sawtooth of fixed amplitude and adjustable period which is applied through switching circuits to the cathode follower and ramp-limiting (clamp) diodes. These diodes fix the voltage limits at the start and stop ends of the ramp. The low voltage end is clamped to near 0 volts by diodes A3CR42, A3CR43, and is adjusted by A3R53. The high voltage end is clamped by A3CR41 to the regulated +156-volt (± 4 volts) supply. The clamped ramp is then applied to the START/CW side of the Ramp Combining Circuit and to the Reciprocal Amplifier.

4-18. The Ramp Generator also supplies two output pulses during its flyback period: 1) a short negative pulse to the Blanking Switch to turn off the RF output during flyback and, 2) a longer negative pulse to the Penlift Circuit that opens relay contacts to lift the pen of an external graphic recorder between sweeps.

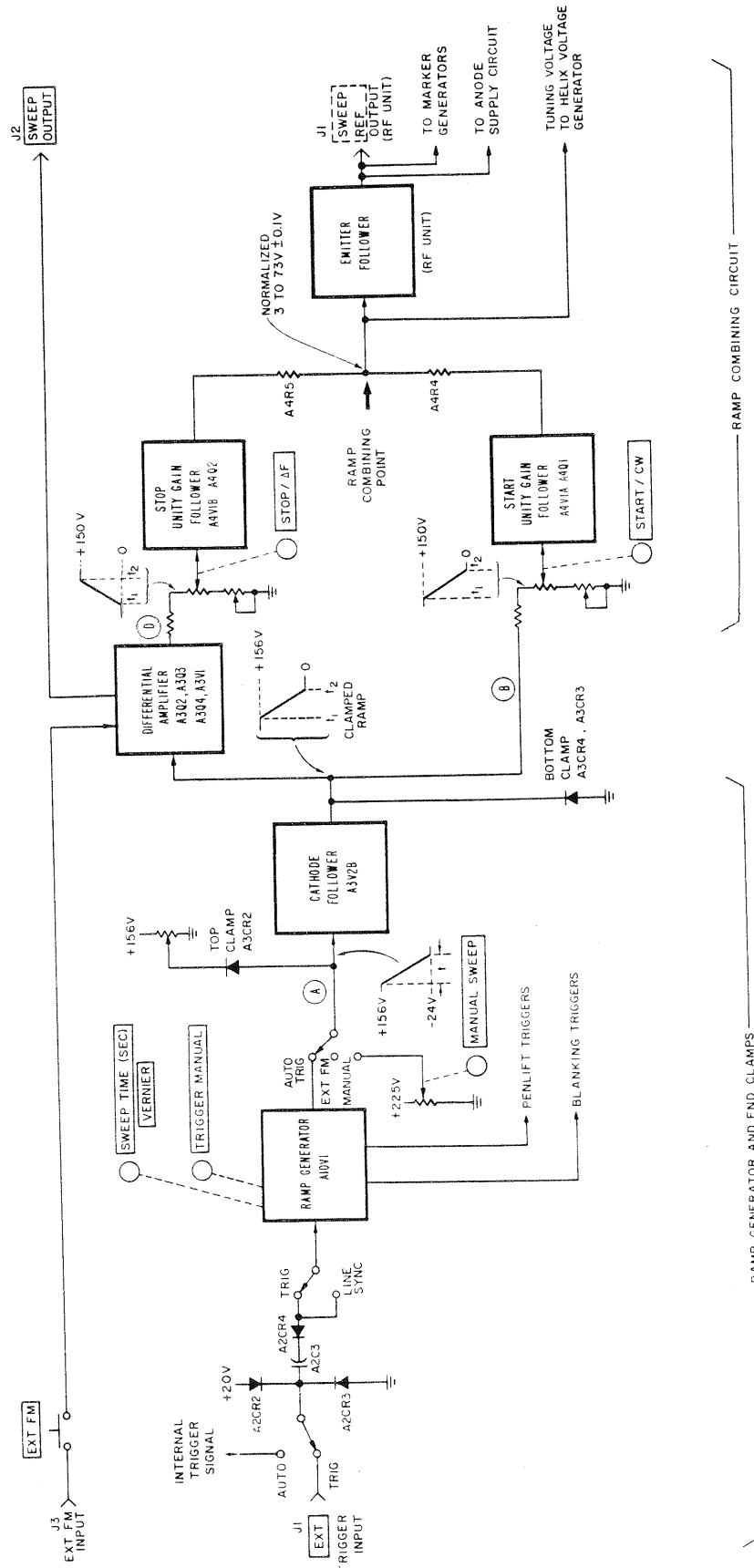

Figure 4-4. Tuning Voltage Generator Block Diagram

4-19. The ramp generator tube operates in a free-run mode for automatically repetitive sweeps, in a trigger mode to start a ramp from a trigger received, or it can be switched off to permit manual frequency control.

4-20. RAMP GENERATOR OPERATION. Ramp Generator tube A10V1, a phantastron, has a two-stage cycle: 1) plate current cutoff, and 2) plate conducting current and producing a linear, negative-going voltage ramp.

4-21. Switching grid (pin 7) switches the tube from one stage to the other. Bias more negative than about -5 volts cuts off plate current and causes the screen grid (half of which is located ahead of the switching grid) to conduct heavily. Bias more positive than about -5 volts allows 1), plate current to flow and start a negative-going ramp and 2), screen current to decrease causing screen voltage to rise and light the SWEEP indicator. Note that, although the SWEEP indicator lights at the start of a ramp, the RF sweep does not start until the ramp voltage crosses the + clamp voltage.

4-22. During AUTO operation, the switching grid receives plate current cutoff bias of about -13 volts from voltage divider A10R7, A10R8; during trigger operation, -40 volt bias is supplied from divider A10R9, A10R10. The bias required to turn plate current on is received from one of three places: 1) for manual trigger operation, pressing the TRIGGER MANUAL button applies a positive-going pulse from C6 directly to the switching grid; 2) for external triggering, an external negative pulse applied through C (Figure 4-5)

to the control grid, causes a positive-going pulse on the screen grid which is coupled through A10R9 to the switching grid; and 3) for AUTO operation, the positive-going plate flyback is delayed by A10R3, A10C2, and applied through A10CR1 to the switching grid. The delay allows the Helix Voltage Generator to recover between sweeps. After plate current has been turned on by any of the foregoing methods, increased screen voltage forward-biases A10CR2 and A10CR3. A10CR2 maintains a positive voltage at switching grid pin 7 to keep A10V1 plate current flowing and complete the ramp.

4-23. After triggering, a "feedback integrator" circuit produces a linear, negative-going, voltage ramp at A10V1 plate. In the circuit, shown simplified in Figure 4-6, C is an integrating capacitor initially charged to the grid-plate voltage of A10V1 (about +235 volts).

4-24. At the instant of triggering, plate current is turned on abruptly by switching grid pin 7. The resultant sharp drop in plate voltage is coupled by grid-plate capacitor C to A10V1 control grid and steps grid voltage enough negative to cause the control grid to assume control of tube current. Capacitor C then begins discharging through resistors A10R1, R2 at a rate determined by the gain of the tube and the RC time constant.

4-25. As plate voltage falls, screen current increases and screen voltage decreases. At a screen voltage of about +73V the reduced voltage at A10R9, A10R10 junction opens diodes A10CR2 and A10CR3. A negative

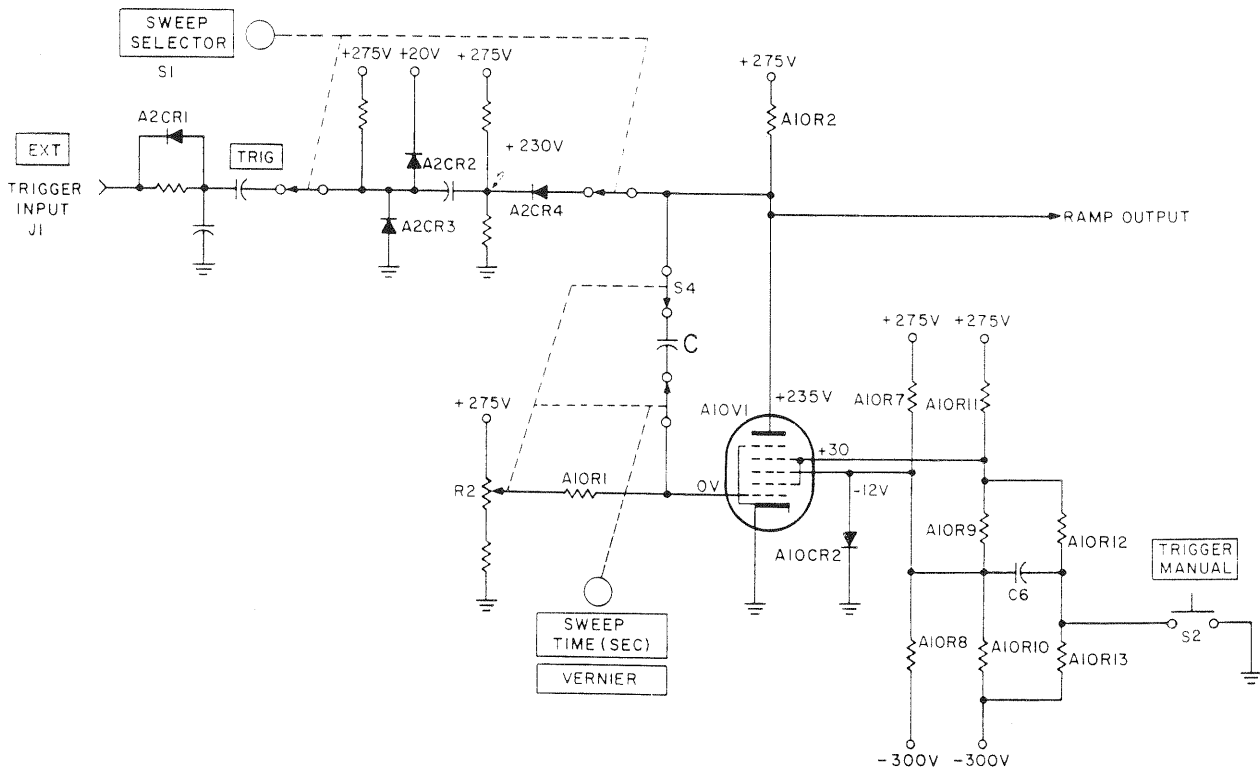

Figure 4-5. Simplified Schematic Diagram of Ramp Generator in Trigger Mode

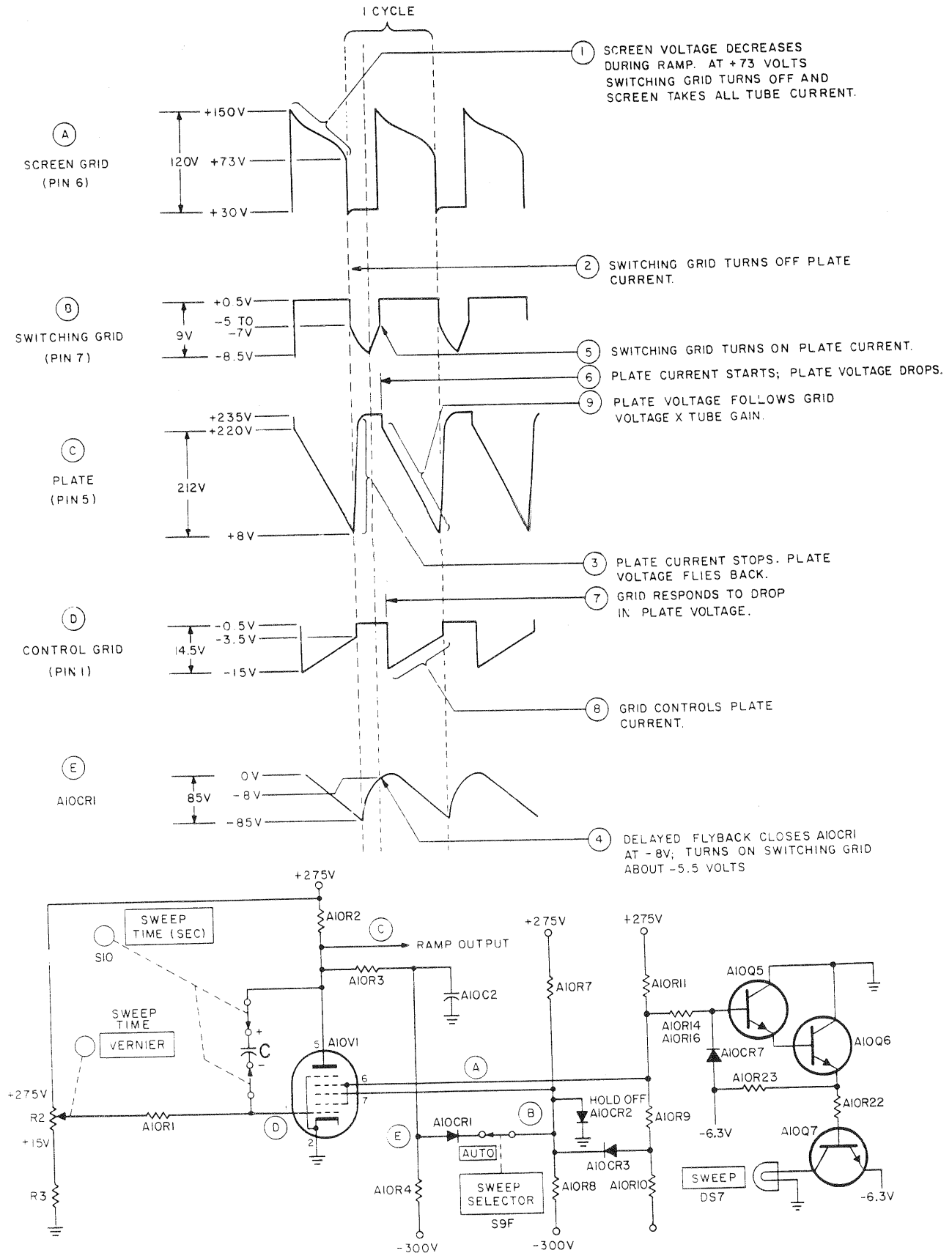

Figure 4-6. Simplified Schematic Diagram of Ramp Generator in Auto Mode

voltage from the A10R7, A10R8 junction is then applied to switching grid pin 7 and cuts off plate current. Plate voltage, control grid voltage and tube current rise sharply. The increased tube current goes to the screen grid reducing screen voltage to a saturation level of +30 volts. Capacitor C recharges through A10R2 and the circuit is ready for another cycle.

4-26. SWEEP TIMING. The SWEEP TIME (SEC) selector connects a different capacitor in the circuit for each time range. To provide continuous adjustment of time between ranges, the VERNIER potentiometer adjusts the voltage supplied to the grid circuit; the more positive the voltage, the faster the grid return, and the shorter the sweep time. To prevent a large transient from occurring when the sweep time range is changed diode CR1 holds the charge on the out-of-circuit timing capacitors to the plate voltage of A10V1 prior to triggering.

4-27. EXTERNAL TRIGGER CIRCUIT. In the external trigger input circuit, Figure 4-5, diode A2CR1 passes only negative-going pulses from the EXT input connector, while clamp diodes A2CR2 and A2CR3 limit the amplitude of the input pulse to 20 volts. Coupling diode A2CR4 is forward-biased by A10V1 plate voltage between ramps to pass negative-going trigger pulses. After triggering, the plate voltage drops and back-biases A2CR4, disconnecting the trigger circuit from the integrator circuit. At the end of the plate flyback, plate voltage again forward-biases A2CR4 and the trigger circuit is reactivated.

4-28. MANUAL TRIGGER CIRCUIT. Manual triggers are generated by S2 (Figure 4-5). Before triggering, the junction of A10R9 and A10R10 is about -30 volts and the junction of A10R12 and A10R13 is about -45 volts, putting a 15-volt charge on C6. Pressing S2 grounds the negative side of this charge, thus applying the +15 volt charge to the switching grid (previously about -30 volts) to start a sweep.

4-29. During the Sweep, the A10R12, A10R13 junction is near +15 volts, the switching grid is +0.6 volt, and the charge on C3 is about 15 volts. Pressing S2 grounds the + end of C3, thus applying a -15 volt pulse to the switching grid which stops the sweep and returns the plate voltage to the start condition. Pressing S2 again starts another sweep.

4-30. BLANKING PULSES. The Ramp Generator produces two pulses, one for the penlift circuit, the other for internal blanking of the RF output. Both pulses are initiated from voltage divider A10R14 and A10R15 between A10V1 screen grid and -300 volts (Figure 4-7, point D). The lowered voltage of the screen grid between sweeps starts both pulses. The penlift pulse is taken directly from point D and lasts until the screen voltage again rises at the start of the next sweep. At the PENLIFT output connector, the penlift signal is an opening of relay contacts for the entire period between sweeps. The RF blanking pulse is terminated before the end of the penlift pulse by the plate flyback voltage delayed by A10R5 and A10C3.

4-31. During the sweep, screen grid voltage drops in step with the plate voltage; point D is clamped to about +1.7 volts through A10CR5 to the bases of A10Q1 and A10Q2. At the end of the sweep, screen grid voltage drops to about +30 volts, and point D drops to about -7 volts cutting off emitter followers A10Q5, A10Q6 to de-energize A9K1 and open the penlift contacts.

4-32. During the sweep, point B is moving from positive to negative, but is clamped by A10CR5 to +1.7 volts at point D. At the end of the sweep, when A10CR5 is opened by the drop in screen voltage, point D is pulled negatively by point C to about -0.5 volt (the clamping voltage of A10CR4) initiating the blanking signal fed to A10Q1.

4-33. During plate voltage flyback point C voltage moves positive and, near the end of the flyback, passes through 0 volts opening A10CR4. Point C excursion stops at +1.2 volts ending the blanking pulse fed to A10Q1. Refer to the explanation of the Blanking Switch for further blanking action.

4-34. THE RECIPROCAL AMPLIFIER.

4-35. For AUTO, ΔF , and MANUAL operation, the Reciprocal Amplifier receives the negative-going ramp from the Ramp Generator and produces a mirror-image, positive-going ramp with identical period and dc voltage limits. This ramp is applied to the STOP/ ΔF side of the Ramp Combining Circuit as shown in Figure 4-4.

4-36. The Reciprocal Amplifier consists of differential amplifier Q2 Q3 Q4, inverter amplifier V1, and emitter follower Q6 on etched circuit board A3. Unity gain is achieved by a degenerative feedback circuit around the entire amplifier as shown in Figure 4-8. The gain of A3V1 is 70 to 75 db, but the net gain of the circuit is equal to the ratio of feedback resistor A3R56 to input (series) resistor A3R55. For swept and single frequency output, equal resistors give unity gain. For external frequency modulation, unequal resistors A2R13 and A2R15 are substituted to obtain amplification.

4-37. The voltage at (2), Figure 4-8, is preset to +78V, half the amplitude of the linear ramp from the Ramp Generator. When operating as a unity gain inverter, the circuit acts to maintain the voltage at (1) equal to the voltage at (2). To achieve this, the circuit produces a positive-going ramp at (3). The instantaneous ramp voltages at (3) and (4) are averaged by resistors A3R55 and A3R56 to produce about +78V at (1). The negative- and positive-going ramps supplied to the Ramp Combining Circuit must have exactly the same dc voltage limits. To obtain this equality, the dc voltage limits of the positive ramp from the Reciprocal Amplifier are adjustable. A3R50 sets the low voltage limit, and A3R75 sets the high voltage limit.

4-38. When the Sweep Oscillator is set for external frequency modulation, the amplifier circuit is modified by 1) replacing the dc reference voltage at A3Q2B gate with the modulation signal, 2) replacing equal resistors A3R56 and A3R55 with unequal resistors

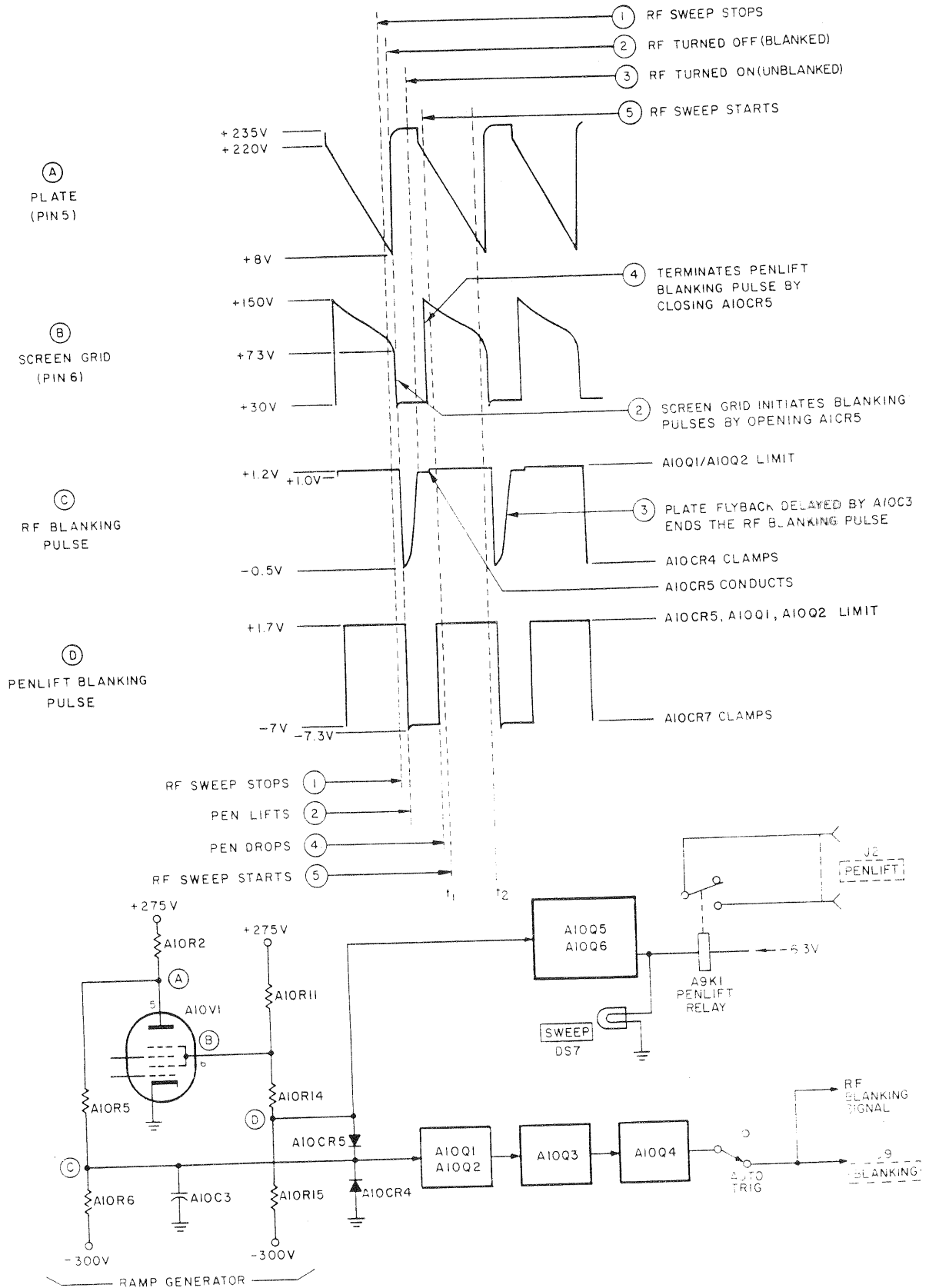

Figure 4-7. Simplified Diagram of Blanking and Penlift Circuits

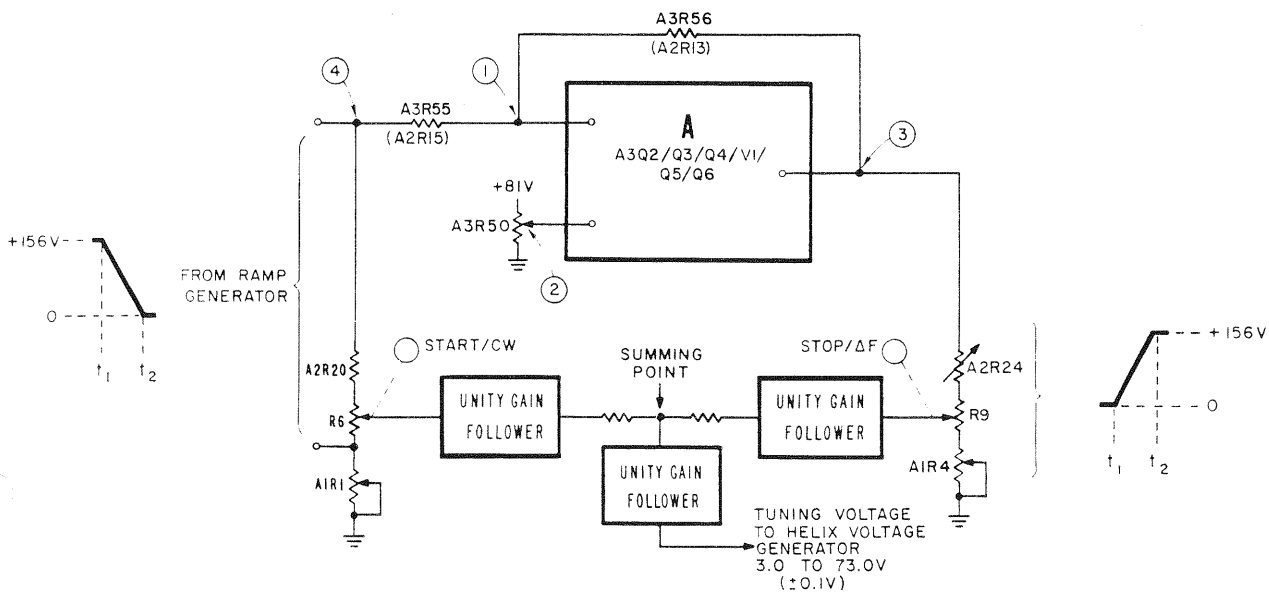

Figure 4-8. Reciprocal Amplifier Functional Schematic Diagram

A2R13 and A2R15 to obtain 10:1 gain, and 3) substituting a dc reference from A2R38 for the ramp voltage. This reference is adjusted so that there is no RF frequency shift when EXT FM is pressed and no modulating signal is applied. The amplified external FM signal, applied to the STOP/ Δ F side of the Ramp Combining Circuit, modulates the dc level at the combining point.

4-39. Diodes A3CR46 and A3CR47 provide the voltage drop necessary to dc-couple the plate of A3V1 to the grid of A4V1B and to A3Q5.

4-40. When the Sweep Oscillator is set to produce a single frequency (CW mode of operation), the reciprocal amplifier is disconnected and the STOP/ Δ F side of the combining circuit is grounded. The Oscillator output frequency is then selected only by the START/CW side.

4-41. THE UNITY GAIN FOLLOWERS.

4-42. The Unity Gain Followers A4V1A/A4Q1 and A4V1B/A4Q2 provide near unity coupling of the negative-going ramp from the START/CW potentiometer to the Ramp Combining Circuit, and of the positive going ramp from the STOP/ Δ F potentiometer to the other side of the Ramp Combining Circuit. The purpose of each follower is to couple the large (up to -150 volt) dc swing of the input ramp to the combining circuit with minimum loss in signal linearity and minimum loading of the potentiometers. This is done for the START/CW side through the emitter follower and diode A4Q1/A4CR1, with cathode follower A4V1A supplying a relatively constant base-collector voltage for the emitter transistor. A4Q2/A4CR2 and A4V1B function in the same way for the STOP/ Δ F side. Unity gain follower A4V2A/A4Q3/A4Q4 provides near unity coupling of the tuning voltage from the summing point to the helix voltage generator.

4-43. THE RAMP COMBINING CIRCUIT.

4-44. The Ramp Combining Circuit controls the dc voltage levels that determine the Oscillator output frequency. The Ramp Combining Circuit consists of the START/CW and STOP/ Δ F potentiometers R6 and R9 on the frequency dial mechanism, Unity Gain Followers Q1/V1A, Q2/V1B and combining resistors R3, R4 on etched circuit A4. Figure 4-9 shows how the FUNCTION pushbuttons and SWEEP SELECTOR connect the Ramp Combining Circuit for the various modes of operation.

4-45. During swept-frequency operation, the Ramp Combining Circuit receives the clamped, negative-going ramp from the Ramp Generator and the mirror-image, positive-going ramp from the Reciprocal Amplifier, adjusts their amplitudes and feeds the adjusted amplitude through Unity Gain Followers to the ramp combining resistors. A resultant ramp of controllable amplitude and direction is produced and fed to the Helix Voltage Generator. By adjusting the amplitude of either or both ramps, the resultant ramp amplitude is made continuously adjustable and either positive- or negative-going. Figure 4-10 shows a downward sweep from the high end of a frequency range (START CW setting) to a frequency of $2/3$ the full range (STOP Δ F setting). Resultant output down ramp (solid line) tunes sweeper output downward from 100% (75 volts) to 66.6% (50 volts) of the full range.

4-46. During Δ F operation, the ramp to the START/CW potentiometer is disconnected and replaced by a static voltage, equal to the upper limit of the ramp, obtained from A2R19 (Figure 4-9). The ramp from the Reciprocal Amplifier is attenuated and applied to the STOP/ Δ F potentiometer. The voltage at the combining point, selected by the START/CW potentiometer, is thus modulated by an amount set by the STOP/ Δ F potentiometer. A2R25 adjusts the amplitude of the

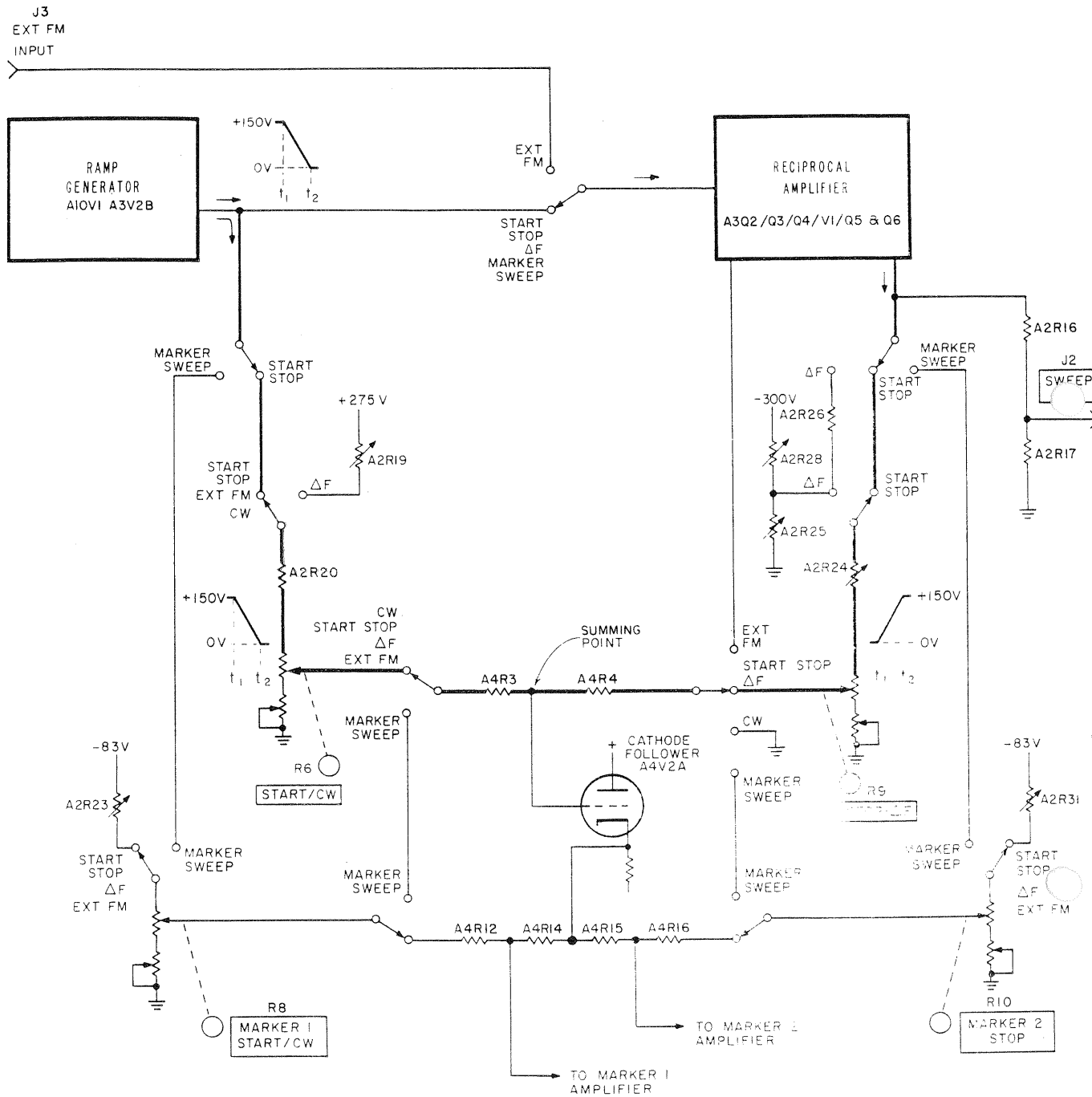

Figure 4-9. Simplified Schematic Diagram of Function Switching.

modulating ramp fed to the STOP/ ΔF potentiometer to give a maximum ΔF sweep equal to 10% of the full Oscillator range (about 15 volts at R9). To prevent shifting the CW (center) frequency set by the START/CW potentiometer as the amount of ΔF is changed, the voltage center of the modulating ramp must be set to exactly 0. The attenuated ramp from A3Q6 is all positive potential; A2R28 shifts the dc limits of the ramp negatively until they are equally above and below zero.

4-47. During CW operation, the Ramp Generator is turned off and the signal fed to the START/CW poten-

tiometer is a steady dc voltage equal to the upper voltage limit of the ramp (+150 volts at R6) obtained from A3V2B cathode. The STOP/ ΔF potentiometer is replaced by a ground. The voltage at the combining point is adjustable from 0 to -75 volts (giving full band coverage) by the START/CW potentiometer.

4-48. During EXT FM operation, the Ramp Generator is disconnected and the signal to the START/CW potentiometer is a steady dc voltage equal to the upper voltage limit of the ramp (+150 volts at R6) obtained from A3V2B cathode. The STOP/ ΔF potentiometer is disconnected and replaced by the external modula-

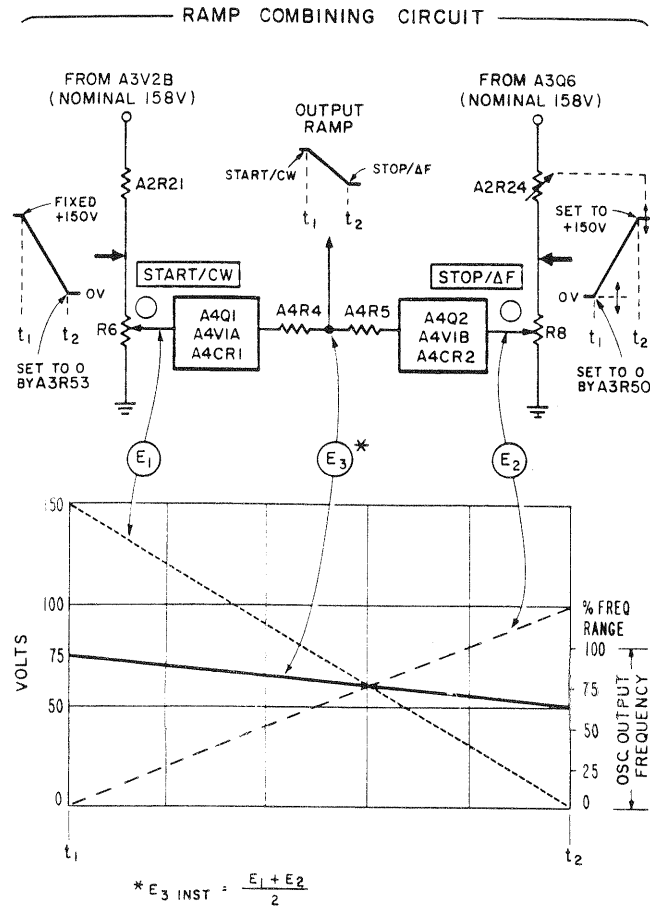

Figure 4-10. Ramp Combining Circuit Simplified Diagram

tion signal. The signal fed to the Helix Voltage Generator is thus a dc voltage that is continuously adjustable, by R6, from 0 to +75 volts, and which is modulated by the external modulation signal.

4-49. During MARKER SWEEP operation, the MARKER 1 potentiometer is substituted for the START/CW potentiometer, and the MARKER 2 potentiometer is substituted for the STOP/ Δ F potentiometer, without any other circuit changes.

4-50. THE HELIX VOLTAGE GENERATOR.

4-51. To sweep the RF output from the backward-wave oscillator tube linearly with time, the voltage applied to the helix must change exponentially with time. The Helix Voltage Generator (Figure 4-11) receives the linear sweep ramp or dc voltage from the Tuning Voltage Generator and converts it to an exponential voltage change within the limits required by the BWO helix and collector.

4-52. The Helix Voltage Generator consists of an electronically regulated power supply for which A8V2 and A8V3 are the series regulators, A4V5 and A4V2B are the differential "comparison" amplifier, and A4V6 is the control amplifier.

4-53. There are two main differences between the Helix Voltage Generator and the power supply shown in Figure 4-14: 1) the dc reference voltage applied to one side of the Comparison Amplifier is replaced by the linear normalized ramp from the Tuning Voltage Generator, and 2) the feedback voltage from the regulator output is obtained through a non-linear voltage divider (shown simplified in Figure 4-11); R_a is a linear element, R_b is the non-linear element. R_b consists of 9 diodes, each with a factory selected resistance in series, connected in parallel to the steps of a voltage divider. At the low-frequency end of the band, when helix voltage is lowest, all diodes are non-conducting; R_b is RF unit potentiometers A2R1, A2R2. As the Oscillator output frequency is tuned upward, helix voltage increases, the diodes conduct one-by-one shunting RF Unit A2R1 and A2R2 with their series resistance and decreasing the value of R_b . Since the gain of differential amplifier is proportional to the ratio R_a/R_b , as R_b decreases the gain increases.

4-54. Because BWO tuning characteristics vary slightly from tube to tube, the factory selected resistances in series with diodes A1CR3-CR11 adjust helix voltage to track the RF output frequency with the frequency dial. Note that as the output frequency increases, more diodes conduct; thus, setting of a lower frequency affects factory resistance values for all higher frequencies.

4-55. Some BWO tubes require collector potential higher than helix potential. For these tubes, the additional collector voltage is supplied by regulated power supply A8CR1, A8V1, the negative side of which is connected to the helix voltage. The collector thus tracks with the helix about 110 volts more positive.

4-56. In the helix voltage regulator circuit, amplifier A4V6 provides the output voltage swing needed to produce the approximate 1000-volt variation from the series regulators. Clamp diode A4CR6 limits A4V6 grid-cathode voltage to about 7 volts during STANDBY operation when the helix voltage supply is disabled and grid voltage would otherwise drop very low. Diode A4CR8 maintains a constant screen-cathode voltage to hold A4V5 gain constant with changing cathode voltage.

4-57. THE ANODE SUPPLY CIRCUIT.

4-58. The RF Unit Anode Voltage Generator A1(A8)Q1, A1(A8)Q6 receives the tuning voltage from A4Q4 and may if desired automatically raise BWO tube anode voltage in the lower half of the RF tuning range to coarse-level BWO output power. Tuning voltages for output frequencies below midband are shifted negatively relative to ground potential in divider A4R8, A4R9. Tuning voltages for frequencies above midband are clamped to ground by A4CR7. Tuning voltage at RF Unit A1(A8)Q1 base is most negative at the lowest output frequency, diminishes to near 0 about midband, and is static above midband. Anode Voltage Shape RF Unit A1R40 sets the amount of anode voltage increase and RF Unit A1R42, Anode Adjust, sets the anode voltage to obtain the cathode current specified by the BWO tube manufacturer.

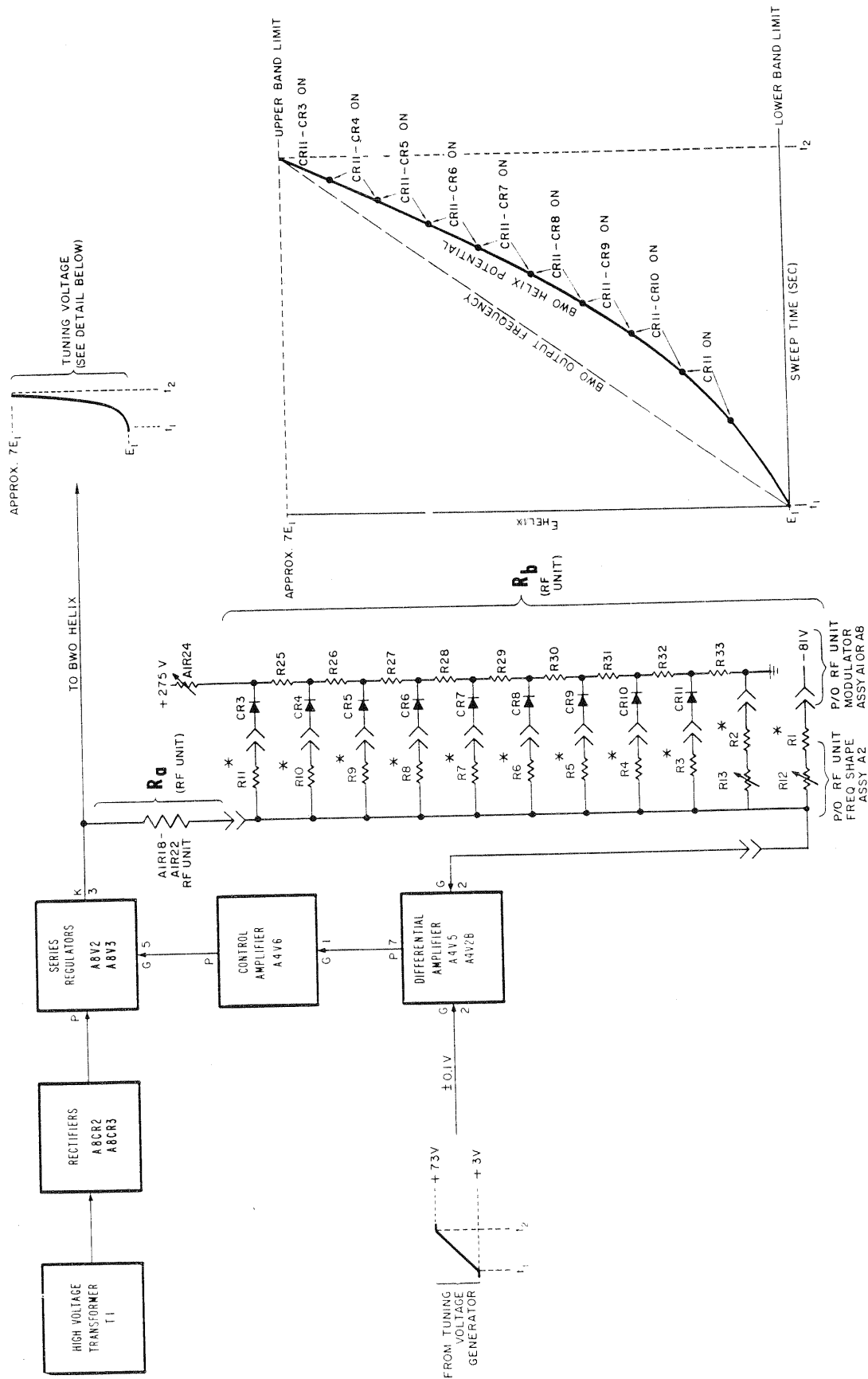

Figure 4-11 Helix Voltage Generator Block Diagram

4-59. During the turn-on delay period, and during STANDBY operation, the BWO tube anode is grounded through A3R33 by contacts of Anode Voltage relay A3K1 to hold BWO cathode current cut off. Other contacts of A3K1 ground A3V2A grid through A3CR7 and A3R31. At the end of the turn-on delay A3K1 is energized and connects the BWO tube anode to the output of cathode follower A3V2A. At the same time A3K1 connects A3CR7. A3C11 junction to +275 volts through A3R30. As capacitor A3C11 charges toward the +275 volts diodes A3CR7 stops conducting. A3CR7 isolates A3V2A grid from A3C11 allowing the anode voltage preset by RF Unit A1R42 to be applied to the BWO tube.

4-60. THE BWO GRID MODULATOR

4-61. The A model RF Units contain a grid modulator, on Assembly A1, that receives amplitude modulation signals. The signals are applied to the BWO grid circuit so as to modulate the BWO beam current without affecting the cathode-anode voltage.

4-62. The BWO tube cathode (beam) current is controlled by RF Unit transistors A1Q2, A1Q3 and associated circuits. Clamp diode A1CR13 prevents excessive negative BWO tube grid voltage. Diode A1CR14 provides a low impedance path for grid current to prevent negative self-bias at the BWO tube grid. Potentiometer A1R14, GRID CUTOFF VOLTAGE ADJUST, provides a small range of grid-to-cathode voltage adjustment to minimize output frequency shift when the BWO cathode is driven to maximum current during a modulation cycle.

4-63. THE AMPLITUDE MODULATION SECTION.

4-64. The Amplitude Modulation Section consists of the Blanking Switch, the Square Wave Generator, and the Frequency Marker Section. All amplitude modulation and RF power level control signals are combined and applied to the Attenuator-Modulator in the RF Section. When the Automatic Level Control Amplifier is in use, all amplitude modulation and RF power level control signals are routed with the ALC signal through the ALC Amplifier before application to the Attenuator-Modulator.

4-65. THE BLANKING SWITCH.

4-66. The Blanking Switch consists of transistors Q1 through Q4 on etched circuit plug-in A10. The purpose of the switch is to provide automatic turn-off of the Sweep Oscillator RF power during automatically recurrent and triggered sweeping when the rear-panel BLANKING switch S13 is set to ON. Automatic RF blanking is possible with automatically leveled RF power.

4-67. The Blanking Switch receives a 1.7-volt pulse from the Ramp Generator and supplies a concurrent

negative 6-volt pulse for application directly to the Attenuator-Modulator or to the ALC Amplifier, depending upon whether the Sweep Oscillator output is unlevelled or leveled. The blanking pulse shape and timing with respect to the RF sweep is shown in Figure 4-7. The switch circuit presents a high input impedance to prevent loading A10R5 in the Ramp Generator and a low output impedance to drive the Attenuator-Modulator or ALC Amplifier. Clamp diode A10CR4 terminates the pulse received from the Ramp Generator at -0.5 volts and prevents excessive negative voltage at the base of A10Q1. The output pulse starts at ground potential and ends at -6 volts. This same pulse is also present at the rear-panel BLANKING output J9 in AUTO and TRIG sweep modes whether or not BLANKING is ON.

4-68. THE SQUARE-WAVE GENERATOR.

4-69. The Square-Wave Generator produces a square wave modulation signal adjustable over a narrow frequency range centered on 1000 cps. It consists of relaxation oscillator A11CR16, A11C3, A11R34, R12, and A2R32; Schmitt Trigger A11Q9, A11Q10, and Emitter Follower A11Q11.

4-70. In the relaxation oscillator, A11C3 charges through A2R32 and R12 toward +275 volts. At +20 volts, four-layer diode A11CR16 triggers itself into conduction, discharges A11C3, and the cycle repeats.

4-71. The sawtooth from the relaxation oscillator, integrated by A11C4, A11R35 and A11R36, switches A11Q9 in and out of conduction as it passes through 0 volts. Diode A11CR17 protects the base of A11Q9 from excessive negative voltage.

4-72. THE FREQUENCY MARKER SECTION.

4-73. The Frequency Marker Circuits produce two independent frequency markers on the swept RF output at frequencies selected separately on the MARKER 1 and MARKER 2 controls. The complete Frequency Marker Section consists of two identical channels, one for MARKER 1, another for MARKER 2. In the following explanation, references to parts and circuits in the MARKER 1 channel apply equally to the MARKER 2 channel.

4-74. The MARKER 1 channel consists of precision potentiometer R8 (MARKER 1) a summing circuit A4R12, A4R14, Cathode Follower A4V4B, Amplifier A11Q5, Marker Generator A11Q6, A11Q7, and Emitter Follower A11Q8.

4-75. The frequency marker pulses can be added to the START STOP sweep, ΔF sweep, or external frequency modulation. Markers cannot be added to the MARKER sweep. To locate the marker at the desired output frequency, a duplicate of the frequency-controlling signal from A4V2A in the ramp combining circuit is fed to the two marker channels in parallel. The instantaneous voltages along this ramp are compared against a reference voltage from the MARKER 1 control through equal resistors A4R12, A4R14 and a difference voltage is obtained from their junction. When this difference voltage passes through 0 volts,

a frequency marker pulse is generated. The dc reference is adjustable so that the zero crossing can be positioned at the point on the input ramp that corresponds to the selected output frequency. For example, for a full band sweep upward in frequency, the ramp voltage input from the Frequency Control Section increases linearly from about +1 volt to about +76 volts. If, for instance, the selected Marker frequency is exactly midband, the voltage at the A4R12, A4R14 junction must cross zero when the input ramp crosses +38.5 volts. For this to happen, the voltage from the marker 1 control must be set for -38.5 volts. (Actually, the marker 1 control voltage must be slightly more negative to compensate for the grid-cathode voltage of Cathode Follower A4V3A). Frequency markers are obtained at any other frequency within the Oscillator tuning range by setting the MARKER 1 reference to equal the instantaneous ramp voltage which corresponds to the output frequency at which a marker is desired.

4-76. Although the foregoing explanation of marker triggering assumes START STOP sweep operation, marker triggering occurs in the same manner for ΔF and EXT FM operation.

4-77. The voltage at the junction of A4R15, A4R16 is amplified by A11Q5, and applied to Marker Generator A11Q6, A11Q7. As the voltage at the A4R12, A4R14 junction crosses zero going positive, it causes A11Q6 collector voltage to fall, and thus form the leading edge of the frequency marker pulse at the junction of A11R25, A11R27. At the same time, this positive-going input is coupled through A11Q6 to the emitter of A11Q7 and causes A11Q7 collector voltage to rise, and thus form the trailing edge of the frequency marker pulse at the junction of A11R25, A11R27.

4-78. The rise and fall of the collector voltages as the input signal goes from negative to positive, or positive to negative, and the resultant voltage at the resistor junction are shown in the graph in Figure 4-12. The resultant voltage (E_3), shown as a perfect "V", is the marker pulse obtained when the A11R30, A11R31 junction voltage is optimum. If the junction voltage is lower, the marker pulse will have a flat bottom: if higher, the pulse will be reduced in amplitude. During the ramp flyback, the Marker Generator is returned to its previous state and a second marker pulse is produced but is obscured by the blanking pulse.

4-79. Clamp diodes A11CR11 and A11CR12 limit the amplitude of the marker pulse and protect A11Q6 and A11Q7 from excessive negative collector voltages. Clamp diode A11CR8 prevents excessive negative voltage at the base of A11Q5; A11CR13 holds A11Q8 base voltage near 0 volts between marker pulses. Before and after the marker pulse, A11CR14 is back-biased to prevent amplitude modulation signals from being fed back into the Marker Generator.

4-80. Cathode Follower A4V4B isolates the summing circuit from transistor amplifier A11Q5. A2R23 (MARKER 1 HF) sets marker 1 frequency at the high end of the Oscillator tuning range. A11R18 (MARKER 1 LF) sets marker 1 frequency at the low end of the Oscillator tuning range.

4-81. When MARKER SWEEP is selected, the grids of A4V3A and A4V3B are grounded, disabling the Frequency Marker Section. Frequency markers are thus not available with the Marker Sweep. The marker sweep is simply a second sweep having all the characteristics of the START STOP sweep except that its start and stop frequencies are selected by the marker settings on the slide rule dial. A marker sweep cannot include markers.

4-82. The marker sweep circuit consists of the MARKER 1 START/CW (R8) and MARKER 2 STOP (R10) potentiometers with calibration adjustments A2R22, A2R30, and A1R2, A1R3 respectively. When MARKER SWEEP is selected, R8 is connected into the Ramp Combining Circuit in place of R6 START/CW (see Figure 4-9) and performs all the functions of R6; R10 is connected into the Ramp Combining Circuit in place of R9, no other marker circuitry is operational. A2R22, A2R30 and A1R2, A1R3 calibrate the MARKER SWEEP so there is no difference in RF output frequency between the START STOP and MARKER sweeps for identical end-point settings.

4-83. THE AUTOMATIC LEVEL CONTROL AMPLIFIER.

4-84. The Automatic Level Control (ALC) Amplifier is for use in a negative-feedback system for reducing

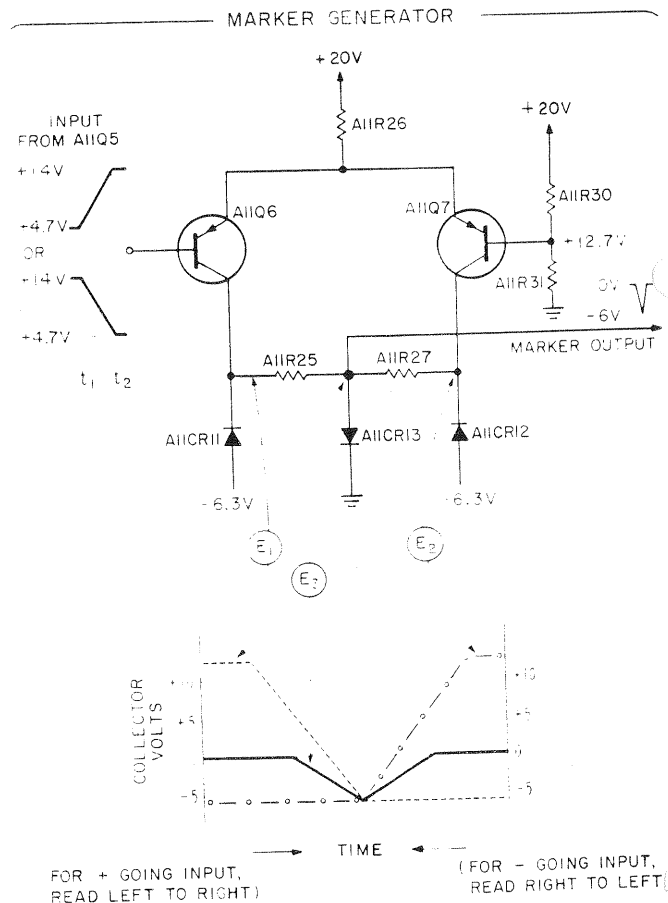

Figure 4-12. Marker Generator Simplified Schematic Diagram

power level variations at the Sweep Oscillator RF output. In the feedback system, the ALC amplifier receives a negative voltage directly proportional to RF power from an external crystal detector or power meter. It compares this voltage against an internal reference voltage and develops a difference signal which is amplified, inverted, and applied to the Attenuator-Modulator. The effect of this difference signal is to hold RF output power nearly constant as output frequency changes. The internal reference voltage is adjustable by the RF Unit POWER LEVEL control R1 to provide manual control of RF output power.

4-85. The ALC Amplifier consists of a modulator, a differential amplifier, a leveling loop monitor, and an ALC gain circuit in the RF Unit. The differential amplifier compares a voltage proportional to RF level to an internal reference voltage and provides a difference voltage. Output amplifier A12Q3 inverts and amplifies the differential amplifier output. The difference voltage is applied to the modulator circuits to level-set RF output power and to reduce RF power variations. For amplitude modulation of RF power leveled by a system using a crystal detector, modulator A11Q12 superimposes amplitude modulation signals on the reference voltage.

4-86. **THE DIFFERENTIAL AMPLIFIER.** The differential amplifier consists of two differential amplifiers that function as one. Double transistor A12Q4 forms an input differential amplifier, and A12Q1, A12Q3 form an output differential amplifier.

4-87. A12V1 couples the high impedance collectors of the input amplifier to the low impedance base circuits of the output amplifier. Reference voltage for the differential amplifier, obtained from RF Unit POWER LEVEL control R1, is applied to A12Q4A base. A voltage proportional to RF power is applied to A12Q4B base, and a difference voltage is obtained at A12Q2 collector.

4-88. Screwdriver-operated RF Unit LEVEL SHUNT A1R1, shunting R1, determines the range of reference voltage available from R1.

4-89. The effectiveness of the RF power leveling system depends upon the gain of the ALC amplifier and the sensitivity of the RF power-sensing device. RF Unit EXT ALC GAIN control R3 adjusts loop gain of the RF leveling system to (1) prevent the system from oscillating at high POWER LEVEL settings when system gain is high, and (2) to optimize leveling performance at low POWER LEVEL settings when system gain is reduced.

4-90. A12Q4 is a dual transistor to equalize dc drift with temperature between the two sides of the input differential amplifier. During RF power leveling, voltages equal within 0.1 mv occur at the bases of A12Q4A and A12Q4B. An indication of significant difference between these voltages is a step in the normally straight-line, between-sweep Oscilloscope display of blanked RF power.

4-91. THE ATTENUATOR-MODULATOR.

4-92. The RF Unit Attenuator-Modulator unit A4 is located in the RF transmission path between Backward-Wave Oscillator tube V1 and the Sweep Oscillator RF output. The unit performs the functions of attenuation, leveling, and amplitude modulation of the BWO tube RF output remote from the BWO tube. This capability results in greater frequency accuracy and stability than application of amplitude-controlling signals directly to the BWO tube.

4-93. The Attenuator-Modulator unit is a current-controlled absorption attenuator which consists of a number of solid state PIN diodes shunting a microwave transmission line. The PIN diode has intrinsic (I) semiconductor material between P and N regions. The intrinsic material causes a forward-biased diode to absorb microwave energy, the amount of absorption being determined by the amount of biasing current: the greater the biasing current, the greater the absorption. Since a single diode cannot absorb enough microwave energy without causing a discontinuity, several diodes, biased in parallel, are spaced along the transmission line. Appropriate control of biasing current permits RF power leveling, RF power attenuation, amplitude modulation and combinations of leveling, attenuation and modulation. The Attenuator-Modulator unit in the Sweep Oscillator has an attenuation range of 30 db minimum produced by a bias current range of about 4 to 7 ma.

4-94. During unlevelled operation amplitude modulation signals are superimposed on diode bias current supplied through RF Unit POWER LEVEL control R1. During automatic RF power leveling bias current for level control and amplitude modulation is supplied by the ALC Amplifier.

4-95. OPTIONAL DIRECTIONAL DETECTOR.

4-96. Directional Detector unit A5, supplied with Option 01 RF Units, completes an internal RF power leveling loop. The Directional Detector is a directional coupler with a crystal detector at the secondary line output. Located between Attenuator-Modulator A4 and the Sweep Oscillator RF output, the Directional Detector samples RF power output and converts level variations in the sample to proportional dc. During automatic leveling, this dc signal is applied to the ALC (leveling) amplifier which controls attenuation in Attenuator-Modulator A4 and reduces RF level variations. INT-EXT switch S1, must be at INTERNAL for internal RF power leveling. The EXTERNAL position opens the internal leveling loop to permit external remote-point and power meter leveling.

4-97. LOW-PASS FILTER.

4-98. Low-Pass Filter FL1 is a passive low-pass RF filter with cut-off frequency close to the upper limit of the Sweep Oscillator frequency range. The filter reduces harmonic effects which degrade RF power leveling.

4-99. THE PRIMARY POWER TURN-ON SEQUENCE.

4-100. Primary power turn-on to the Sweep Oscillator circuits occurs in timed stages to provide longer life and protection for the expensive BWO tube and other components. At turn-on, thermistor A9RT1 prevents a high-current surge in the ac-operated tube heaters and power supplies connected to T2. Initially, there is a 40-volt drop across A9RT1 that diminishes to 1 volt in about 15 seconds. Time delay circuit A8C6, A8R13, A8Q1, K2 prevents application of operating helix and anode voltages to the BWO tube before the BWO tube cathode reaches operating temperature. The delay period starts after the -6.3 and +20 volt supplies are turned on. A8C6 then begins to charge toward these voltages through A8R13. Eventually (60-120 seconds), the charge on A8C6 forward-biases A8Q1 which actuates K2. Contacts of K2 energize T1 primary winding and actuate A3K1 to energize the helix and anode voltage generators. The +20 volt supply and relay K2 are interlocked by the RF Unit. The primary power turn-on sequence is shown in the diagram of Figure 4-13.

4-101. To protect the BWO tube from excessive heater voltage or helix current, the turn-on circuits are held operational by safe values of helix current and heater voltage, and are released if either is excessive. This power shut-off results in a lock-out condition that requires the LINE switch to be set to OFF before normal operation can be restored. The BWO tube anode is protected from excessive dissipation by fuse F1.

4-102. THE POWER SUPPLIES.**4-103. GENERAL OPERATING PRINCIPLES.**

4-104. All the dc operating voltages shown in Figure 4-2 are electronically regulated. Some are obtained directly from regulated supplies, others are derived by voltage division from regulated supplies.

4-105. There are five transistor type electronic regulated power supplies providing +275, -300, +20, 12.6 and -6.3 volts. All of the regulators operate as follows. As shown in Figure 4-14, a regulating element (Series Regulator) is connected in series with the load and the dc power source (Rectifier). The resistance of the regulating element is made adjustable so that the voltage at its output will be adjustable. The resistance is adjusted by a control voltage; the higher the control voltage, the higher the output voltage. A sample of the Series Regulator output voltage is compared against a stable dc reference voltage by a Comparison Amplifier and the difference voltage is inverted and applied to the Series Regulator. As a result, any tendency

for output voltage to change is immediately counteracted by the control voltage, and the supply output voltage remains constant.

4-106. Since the gain of the Comparison Amplifier determines the degree of regulation, it may be followed by an additional control, or driver, amplifier to improve regulation. The Comparison Amplifier is a differential type for temperature stability. The dc reference voltage used for comparison is obtained from voltage regulator electron tubes, from semiconductor voltage reference diodes, or by voltage division from another regulated power supply. When an adjustable power supply is used as the reference for another supply, changing its output level also changes the level of the supply for which it is the reference.

4-107. +275 AND -300V POWER SUPPLY TURN-ON SEQUENCE.

4-108. The following paragraphs describe the +275V power supply. A similar description applies to the -300V supply, with exceptions noted.

4-109. A5CR1, A5CR2 and A5CR3 form a voltage reference stick, and provide +180V to forward bias A5CR20. Current flows through A5R29 and A5R24, and then into the base of A6Q7. A5V1 will not conduct at first because filaments have not heated.

4-110. The resulting large A6Q7 base current (about 0.9 mA) causes A6Q7 to saturate. The high A8Q7 collector current robs base current from A6Q6 and shunts off series regulator A6Q10 by making A6Q5 and A6Q10 collector currents zero. This prevents current flow through the series regulator. Because A6Q10 is cut off, the impedance of the power supply is high and very little current flows through A5R34 into the +275V supply load.

4-111. Voltage at A6F1 (input to the +275V supply voltage limiter) is about 360V. Thus, current flows through A5R2, A6CR4, A6CR5, A6R6 and A6Q7. Initial +40V output voltage is established by voltage division between A5R2 and A6R6. The output voltage stays at about 40V magnitude (+ for +275V supply; - for -300V supply) until after A5V1 vacuum tube filaments have heated up. The output voltages track as they increase from the 40V level to the normal output levels.

4-112. A few seconds after turn-on, A5V1 conducts and shunts base current formerly available to A6Q7. A6Q7 collector current then decreases, allowing current to flow through the base of A6Q6. Series regulator A6Q10 then conducts only through the load impedance because the current path through A6CR5 and A6R6 is closed by limited A6Q7 base current.

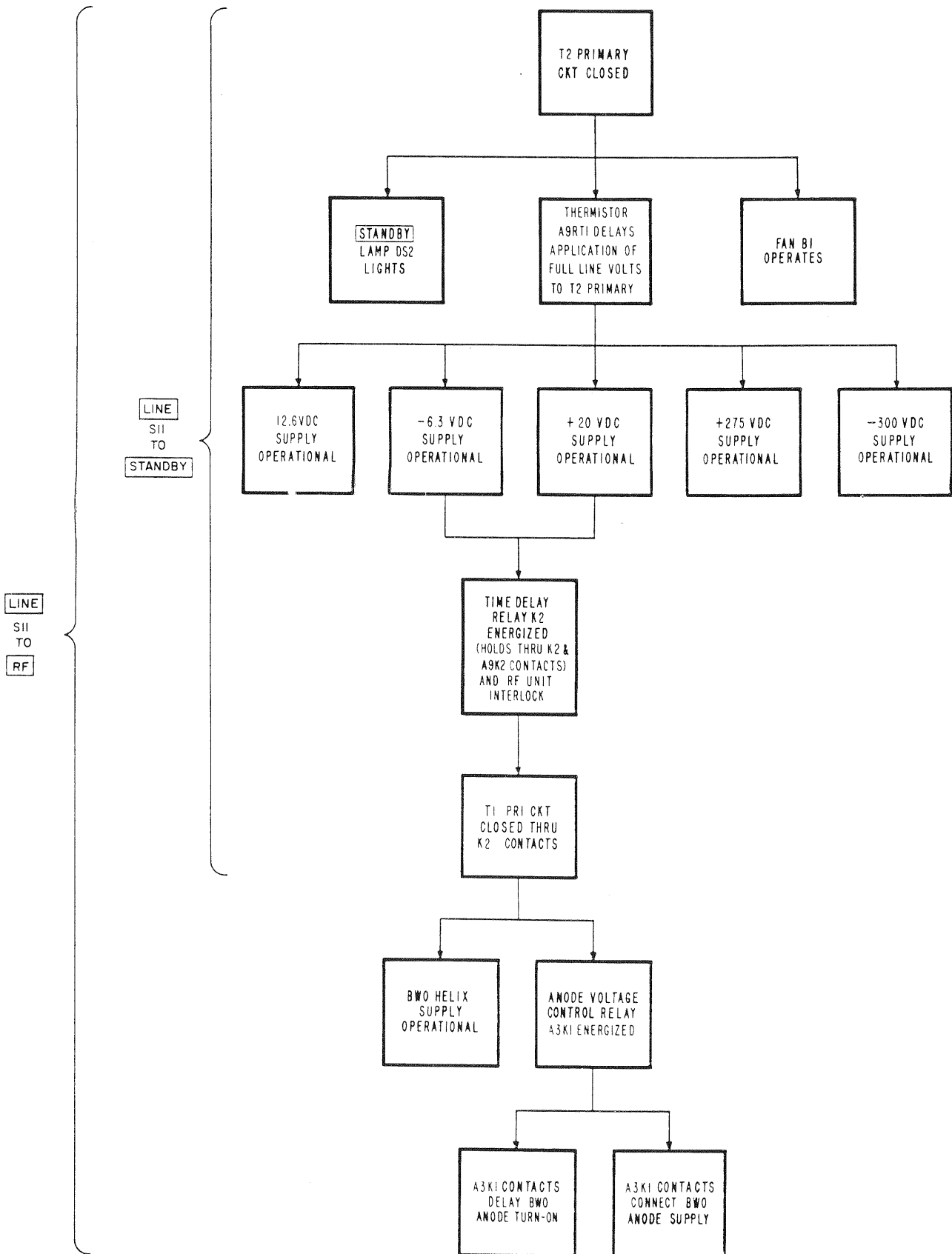

Figure 4-13. Turn-On Sequence Diagram

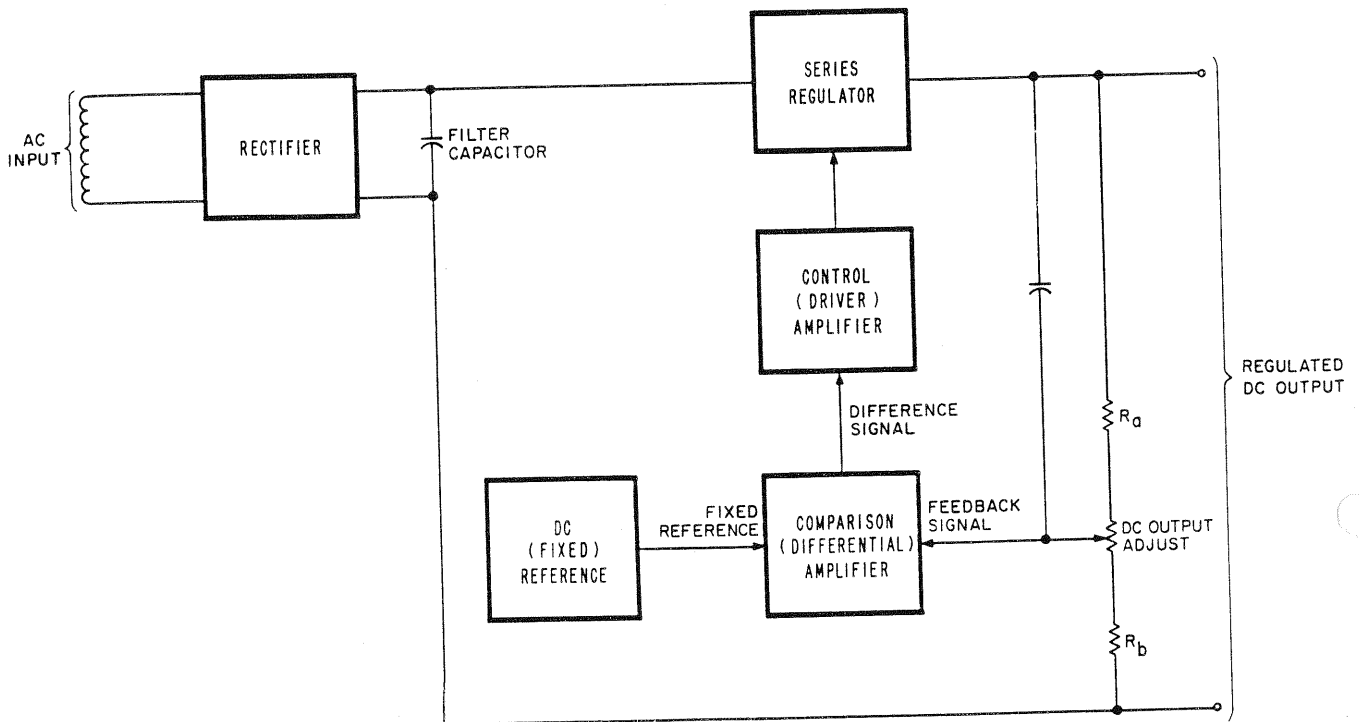

Figure 4-14. Regulated Power Supply Block Diagram

4-113. The output voltage begins to rise as A6Q10 collector current flows into the load and charges C8B. When the output reaches +275V, A5V1 shunts just enough current away from the base of A6Q7 to control the output current, maintaining a constant voltage regardless of the load impedance. The initial conditions hold until A5V1 begins to conduct appreciable current and the power supply outputs increase in voltage toward a stable condition.

4-114. When the -300V supply output voltage increases more negative than -82V, A5V2 turns on to regulate the A5Q1 and A5Q2A base voltages at this level. When the output voltage is -300V, voltage at the center tap of A5R7 -300V ADJ is set to -82V and A5Q2A will take over control of the A6Q9 base current. This control establishes the stabilized -300V output voltage.

4-115. Since the voltage difference between A5V1 cathode and A5CR14 cathode is less than 10V, A5CR17 prevents current from passing through A5R16 and into A5R22 when a stable condition is reached. This minimizes +275V supply drift by reverse biasing A5CR15; i.e., there are no voltage variations across non-conducting A5CR15.

4-116. +275V AND -300V POWER SUPPLY INTERDEPENDENCE.

4-117. When the +275V supply output voltage exceeds +180V, A5CR21 conducts, A5CR20 is reverse biased, and A5V1 is supplied with a well regulated plate voltage. A5V1 can conduct the proper current only if the

-300V supply voltage for A5R22, A5R23 and A5R26 is approximately correct. Thus, the +275V supply is dependent on the -300V supply for proper operation.

4-118. Further, the -300V supply needs correct bias current supply by the +275V supply. The -300V supply sequences through the following states as the output voltage increases from -40V to -300V.

4-119. At turn-on, some of the A5R15 (next to test loop B) current flows through the base of A6Q9, turning on A6Q9, A6Q8 and the -300V series regulator A6Q11. A6Q11 collector current passes through the -300V supply load impedance and develops an output voltage which is controlled by the relationship between A5R15, A5R16 and A5R22. Assuming that A6Q9 base current is negligible and that the voltage at A5CR14 cathode is always about 4.5 volts, the current flowing through A5R15 will also flow through A5R16 and A5R22 (A5V1 is off because filaments have not yet heated) and will develop a voltage at test point 1 about equal but of opposite polarity to the voltage at test point 2, because the resistive sum of A5R22 and A5R16 is about equal to A5R15. The two power supply outputs approximately track each other during turn-on because equal currents flowing through equal resistances yield equal voltages. The small base current required by A6Q6 to maintain tracking is controlled by the voltage at either end of the A5R15/A5R16/A5R22 resistor stick.

4-120. +275 AND -300V CURRENT LIMITERS.

4-121. The two current limiters are identical in function; the following paragraphs describe the +275V current limiter. The current limiters are similar to

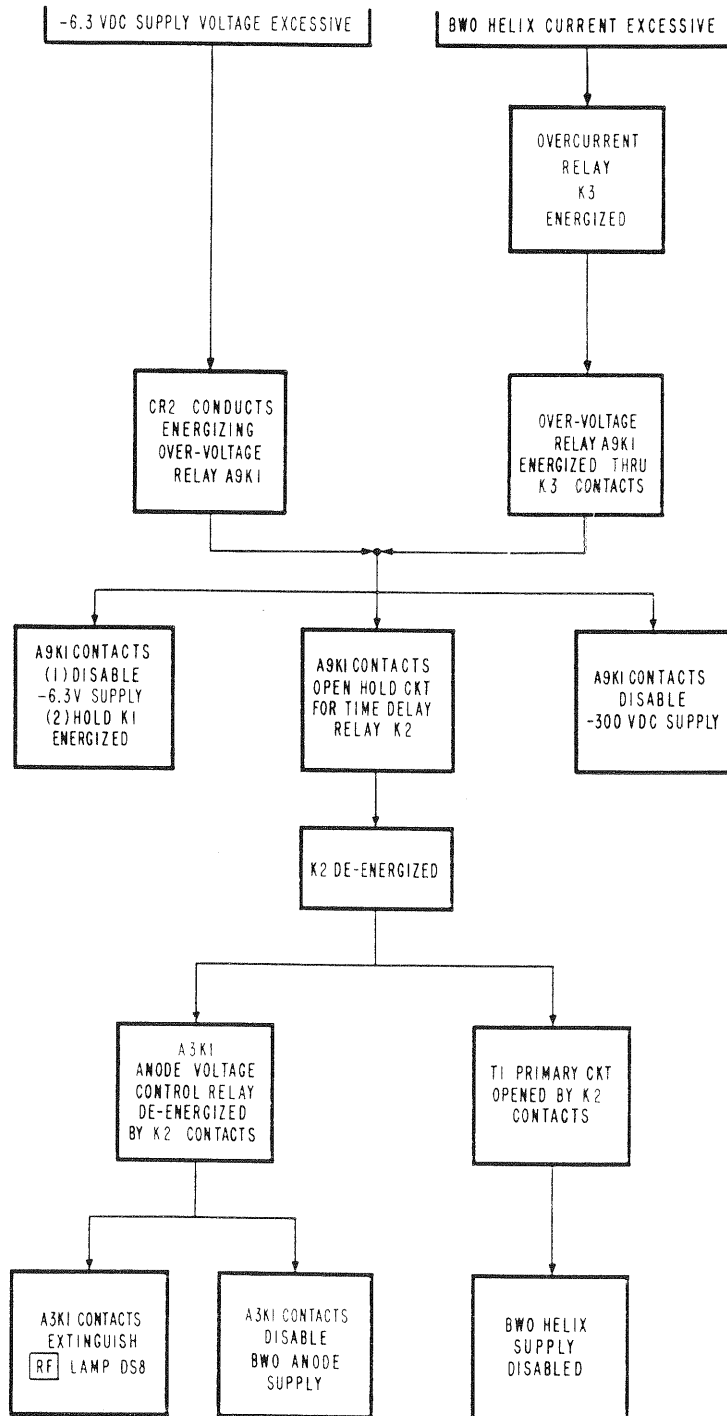

Figure 4-15. Sequence Diagram for BWO Tube Heater Over-Voltage and Helix Over-Current Protection

a bridge circuit. A5Q4 acts as a switch to shunt base current away from A6Q6 which drives the series regulator, thus turning off the current available to the load. The unique characteristic of the circuit is that the maximum current available to the load is roughly proportional to output voltage.

4-122. Under normal operating conditions A5Q4 is turned off and the series regulator can have as much base current as it needs. If the load resistance begins to decrease so that the load current increases, A6Q10 emitter voltage increases due to the increase of voltage across A5R34. A5Q4 base voltage also increases and eventually exceeds A5Q4 emitter voltage. This turns on A5Q4, unbalances the bridge and provides a current path from the base of A6Q6 to the emitter of A5Q4, limiting the base current available to A6Q6.

4-123. Once A5Q4 collector current starts to flow, the output voltage decreases as series regulator A6Q10 base current is limited. A6Q7 will cut off as the feedback circuit tries to restore the output voltage, but the resulting extra base current available for the base of A6Q6 will be limited by the amount of A5Q4 collector current. With this limiting, the output voltage is no longer controlled by the feedback circuit, but is instead controlled by the current limiting circuit.

4-124. +275V AND -300V VOLTAGE LIMITERS.

4-125. The two voltage limiters are identical in function; the following paragraphs describe the +275V voltage limiter. The +275V voltage limiting circuit works in conjunction with the +275V current limiter to control voltage and current levels during all phases of turn-on, normal operation, and short circuit operation.

4-126. Under normal operating conditions, A5Q4 emitter (+275V output) is at +275V so that the voltage difference between this point and the collectors of A6Q1 and A6Q3 is about 125V. (Maximum voltage at A6Q3 is +400V at high line.) With only 125V available, A6CR1 and A6CR2 will not conduct so that A6Q1 and A6Q3 will saturate. In this state, the voltage drop between the A6Q1 A6Q3 collectors and the collector of A6Q10 is nearly zero. Thus, the A6Q10 series regulator collector to emitter voltage is a maximum of 125V: a safe level for collector currents in excess of 200 mA.

4-127. If the +275V supply load resistance should suddenly decrease to zero, A6Q10 emitter voltage will be about zero. A maximum of +400V at A6F1 will drop across A6R1 A6R2 A6CR1 A6R15 A6CR2. A6CR1 and A6CR2 together drop approximately +140V, leaving 260V drop across A6R1 and A6R2. Disregarding A6Q1 base current, A6Q10 collector voltage level is then about 270V, i.e., the collector voltage of A6Q10 is about the same as the voltage at the junction of A6R1 and A6R2. In this state, series regulator A6Q10 collector to emitter voltage will be about 270V. This is a safe level because the current limiter limits the current through A6Q10. A6CR1 A6CR2 and A6R1 A6R2 values are such that for any combination of load current and output voltage, the voltage across A6Q3 collector to emitter will be large enough to limit the series regulator power dissipation within safe limits.

4-128. THE -6.3 VOLT SUPPLY.

4-129. The -6.3 volt supply provides electron tube heater power as well as transistor operating power and clamp reference voltages for various circuits. The supply operates as explained under General Operating Principles except that it is self-referenced and requires two series regulators (Q2, Q3, and A14Q4) in parallel to supply the required current.

4-131. The -6.3 volt supply has over-voltage prevention to protect the BWO tube heater from excessive voltage resulting from a short-circuit of one of the series regulator transistors. The over-voltage prevention circuit, A9K2, A9CR17, A9R8, and A9R9 disconnects the supply from its rectifier and initiates an action which removes the other BWO tube operating voltages. If a series regulator transistor short circuits, the supply output voltage rises enough to cause breakdown diode CR2 to conduct and provide an operate circuit for heater Over-Voltage relay A9K1. A9K1 energizes. K1 contacts disconnect rectifiers A9CR7, A9CR8 from the -6.3 volt regulator and connect their output directly to the coil of A9K1, holding A9K1 operating. The complete sequence for removing the BWO tube operating voltages is shown diagrammatically in Figure 4-15. The Sweep Oscillator remains in the state shown in Figure 4-15 until LINE S11 is set to the off position, allowing the relays to reset for a normal turn-on cycle. The time delay will not recycle unless the RF Unit is installed. However, a turn-on cycle should not be restarted until the cause of shutdown has been investigated.

4-132. THE 12.6 VOLT SUPPLY.

4-133. The 12.6 volt supply provides regulated electron tube heater power. The positive side of the supply is connected to a +65 volt tap on voltage divider A14R4, A14R5 from which the supply maintains -12.6 volt difference. The regulator output voltage is coupled, without signal loss, by A14CR2 to the base of A14Q1. This base signal is inverted and amplified in A14Q1, and applied to A14Q2 base. Current-amplified in A14Q2, the signal becomes degenerative feedback at the base of series regulator Q4 to counteract voltage variations at Q4 base.

4-134. THE +20 VOLT SUPPLY.

4-135. The +20 volt supply provides regulated transistor operating power. The regulator circuit operates as explained under General Operating Principles. DC reference for the Comparison Amplifier is obtained from voltage divider A14R8, A14R9 connected between the regulated +275 volts and ground potential. The Comparison Amplifier A14Q5, A14Q6 is followed by current amplifier (Driver) A14Q3 which supplies base current to Series Regulator Q1.

4-136. **BWO TUBE HELIX OVER-CURRENT PROTECTION.**

DC reference for the Comparison Amplifier is obtained from voltage divider A14R8, A14R9 connected between the regulated +275 volts and ground potential. The Comparison Amplifier A14Q5, A14Q6 is followed by current amplifier (Driver) A14Q3 which supplies base current to Series Regulator Q1.

4-136. BWO TUBE HELIX OVER-CURRENT PROTECTION.

4-137. The BWO tube helix is protected from excessive current by Overload Relay K3. Each type of backward-wave oscillator tube has a maximum helix

current rating which is specified by the tube manufacturer. This rating insures that helix power dissipation remains within safe operating limits. Overload Relay K3, in series with the Helix Voltage Generator, disconnects operating voltage from the helix if helix current exceeds the tube manufacturer's specified maximum. If helix current exceeds the operate value for the overload relay, the relay is energized to remove all operating voltages from the BWO tube as shown diagrammatically in Figure 4-15. The Sweep Oscillator remains in the state shown at the end of the sequence in Figure 4-15 until LINE S11 is set to the off position, allowing the relays to reset for a normal turn-on cycle. However, a turn-on cycle should not be restarted until the cause of shut-down has been investigated.

SECTION V MAINTENANCE

5-1. INTRODUCTION.

5-2. This section provides instructions and information to (1) perform performance tests, (2) make adjustments and perform calibration, (3) troubleshoot, and (4) repair the 8690B Sweep Oscillator. Where applicable, these procedures include the information required to perform maintenance on the 8690 series RF Units used with the 8690B.

5-3. **TEST EQUIPMENT REQUIRED.** The test instruments required for maintenance are listed in Table 5-1. Test instruments other than those listed may be used provided performance equals or exceeds Critical Specifications.

5-4. MAINTENANCE PRECAUTIONS.

WARNINGS

VOLTAGES IN EXCESS OF 1000 VOLTS INSIDE CABINET

- top side near fan on A8V2 and A8V3 plate (anode) connectors
- under side on exposed T1, C2 and C3 terminals
- right side on BWO tube terminal assembly A3, RF Unit
- left side on high voltage power supply assembly A8

DO NOT SHORT CIRCUIT CASES OF CHASSIS-MOUNTED TRANSISTORS TO CHASSIS.

5-5. PERIODIC MAINTENANCE

5-6. CLEANING THE RF UNIT AIR FILTER.

5-7. Inspect the air filter regularly and, if necessary, remove and wash it in detergent and water. Unrestricted air flow gives longest component life. Keep the filter clean.

5-8. LUBRICATION

5-9. No routine lubrication is needed. Mechanical parts are lubricated at the factory.

5-14. PERFORMANCE TESTS.

5-15. The procedures listed in Table 5-2 test the electrical performance of the 8690 series Sweep Oscillator-RF Unit combinations for: (1) Incoming inspection, (2) Periodic evaluation, (3) Calibration, and (4) Testing after repair. The tests can be performed without access to the instrument interior. Specifications of Section I in this manual, and in the applicable RF Unit manual, are the performance standards. If the Sweep Oscillator-RF Unit combination fails to meet any of the performance test specifications, and a circuit malfunction is not suspected, refer to the adjustment procedures. If a circuit malfunction is suspected, refer to the troubleshooting paragraphs.

Table 5-1. Test Equipment Required for Maintenance

Instrument	Critical Specifications	Recommended Models
Adjustable line voltage transformer	Voltage Range: 90 to 130 volts Current: 7.5 amperes Voltmeter Accuracy: ± 1 volt	General Radio W10MT3A Superior Electric UC1M
Oscilloscope	Vertical Bandwidth: 5 MHz Vertical Sensitivity: 5 mV/cm Sweep Time Accuracy: $\pm 3\%$	HP140 with 1402 and 1420 Plug-Ins HP175 with 1752 Plug-In
Crystal Detector	Frequency Range: Same as RF Unit used Sensitivity: 100 mV dc from < 0.35 mW, high level: > 0.4 mV dc/ μ W, low level Frequency Response: ± 0.5 dB or better	HP 423
Fixed Attenuator	Frequency Range: Same as RF Unit used Attenuation: 3, 6, 10, 20, 30 dB as required	HP8491 Op. 03 = 3 dB 06 = 6 dB 10 = 10 dB 20 = 20 dB 30 = 30 dB
Frequency Meter	Frequency Range: Same as RF Unit used Accuracy: $\pm 0.1\%$	HP536 HP537 HP 532 series for waveguide bands
Power Meter and Thermistor Mount	Frequency Range: Same as RF Unit used Power Range: 1μ W to 10 mW	HP 432 with HP 8478 and HP 486
Waveguide-to-Coaxial Adapter	Frequency Range: Same as RF Unit used	HPH, X281
Square-Wave Generator	Frequency Range: 40 to 1200 Hz Output: -13 volts peak Symmetry: 50-50	HP211
Audio Oscillator	Frequency Range: 100 Hz ± 10 Hz Output: 0 - 14 Vrms	HP 200, 201
AC Voltmeter	Average - responding, rms calibrated Range: -28 to -60 dEm minimum Accuracy: $\pm 5\%$	HP 400
DC Voltmeter	Range: 0 to ± 300 volts Accuracy: $\pm 3\%$ Input Impedance: 20k, ohms/volt	HP 3460B
DC Voltage Source	Output: regulated, variable Range: 0 - 20 volts Polarity: negative	HP 721 Transistor Power Supply

TABLE 5-2. PERFORMANCE TESTS

NOTE

ALLOW 30 MINUTES WARM UP.

1. Power Variation, Unleveled.

Procedure

- a. Connect equipment as shown in Figure 5-1. Omit connection of oscilloscope.
- b. Set RF Unit controls as follows:
 ALC (Option 01) EXT
 POWER LEVEL MAX CW
- c. Set 8690 controls as follows:
 PWR MTR LEVEL OFF SWEEP TIME VERNIER MAX CCW
 ALC RELEASED START /CW Low end of specified range
 SWEEP SELECTOR TRIGGER STOP /Δ F High end of specified range
 SWEEP TIME (SEC) 100-10 LINE RF
- d. Press MANUAL TRIGGER pushbutton.
- e. Measure power output over specified RF Unit frequency range.
- f. TEST LIMIT: Maximum power output variation less than 10 dB.

2. Power Variation, External Leveling.

Procedure

- a. Connect equipment as shown in Figure 5-3 according to RF Unit model used. Omit connections A and B.
- b. Set RF Unit controls as follows:
 ALC (Option 01) EXT
 POWER LEVEL MAX CCW
- c. Set 8690B controls as follows:
 ALC DEPRESSED
 SWEEP SELECTOR CW
 START /CW Low end of specified range
 STOP /Δ F High end of specified range
 LINE RF
- d. Set POWER LEVEL for maximum leveled power output (as indicated by UNLEVELED light).
- e. Measure maximum leveled power output on power meter. Compensate for characteristic changes with frequency for the cables, attenuator, adapter, and calibration factor of thermistor mount, if any.
- f. Measure dc level, V1, at XTAL ALC connector using oscilloscope.
- g. Set POWER LEVEL for a -1.0 dB change in power meter reading.
- h. Measure dc level, V2, at XTAL ALC connector using oscilloscope.
- i. Calculate the test limit for an ALC signal change which corresponds to (A) ±0.2 (0.4 pk-pk) dB power output variation, or (B) ±0.1 (0.2 pk-pk) dB power output variation according to RF Unit model used:
 (A): $\frac{V1 - V2}{2.5}$ (V, pk-pk) (B): $\frac{V1 - V2}{5}$ (V, pk-pk)
 (A type RF Units) (B type RF Units)
- j. Set 8690 SWEEP SELECTOR to AUTO.
- k. Set POWER LEVEL for maximum leveled power output (as indicated by UNLEVELED light).
- l. Measure voltage variation in ALC signal.
- m. TEST LIMIT: The (V, Pk-Pk) value calculated above. This test limit excludes coupler and detector variation. Maximum power output variation in dB as follows:
 All "A" Model RF Units: ±0.2 dB
 All "B" Model RF Units: ±0.1 dB

(Continued)

TABLE 5-2. PERFORMANCE TESTS

3. Power Variation, Internal Leveling (Option 01 RF Units).

Procedure

- a. Connect equipment as shown in Figure 5-1 to include power meter, thermistor mount and attenuator. Omit connection to oscilloscope.
- b. Set RF Unit controls as follows:
 ALC (Option 01) INT
 POWER LEVEL MAX CCW
- c. Set 8690B controls as follows:
 ALC DEPRESSED
 SWEEP SELECTOR TRIGGER
 SWEEP TIME (SEC) 100-10
 START/CW Low end of specified range
 STOP/ΔF High end of specified range
 LINE RF
- d. Press MANUAL TRIGGER pushbutton.
- e. Set POWER LEVEL for maximum leveled power output (as indicated by UNLEVELED light).
- f. Measure power output over specified RF Unit frequency range. Compensate for characteristic changes with frequency for the cables, attenuator and calibration factor of the thermistor mount, if any.
- g. TEST LIMIT: Maximum power output variation in dB as follows:

8691A: ±0.4 dB	8693B option 100: ±0.4 dB	
8692A: ±0.4 dB	8694A/B: ±0.75 dB	
8693A: ±0.5 dB	8694A/B option 100: ±0.75 dB	
8693B: ±0.4 dB	8694A/B option 200: ±0.75 dB	

4. Maximum Leveled Power Output.

Procedure

- a. Perform steps a through e of Performance Test 2, except set Option 01 RF Unit ALC switch to INT.
- b. TEST LIMIT: As specified in Table 1-1. Summary of Specifications.

5. Start/CW Accuracy (Start-Stop Function).

Procedure

- a. Connect equipment as shown in Figure 5-2, according to RF Unit model used. Omit connections A, B, and C. Omit the directional detector combination at the RF output connector.
- b. Set the RF Unit controls as follows:
 POWER LEVEL MAX CW
 ALC (Option 01) EXT
- c. Set 8690 controls as follows:
 AMPLITUDE MOD pushbuttons All released
 ALC Released
 LINE RF
- d. Adjust oscilloscope to observe CRT beam dot displacement as frequency meter is tuned through RF output frequency. An oscilloscope horizontal sweep is not required.
- e. Set 8690 controls as follows:
 START STOP Depressed
 SWEEP SELECTOR CW
 START CW Low end of specified range
 STOP ΔF High end of specified range
- f. Tune frequency meter to obtain maximum vertical displacement of oscilloscope display. Note and record difference in frequency reading between frequency meter and START CW dial indicator. Repeat for START CW at midpoint and then at high end of specified range.
- g. TEST LIMIT: The START/CW dial indicator and frequency meter reading agree to within the applicable RF Unit Frequency Accuracy specifications listed in Table 1-1.

(Continued)

TABLE 5-2. PERFORMANCE TESTS

6. Start/CW Accuracy (ΔF Function).

Procedure

- a. Perform steps a through d of Performance Test 5.
- b. Set 8690B controls as follows:
 - ΔF Depressed
 - SWEEP SELECTOR CW
 - START/CW Low end of specified range
 - STOP/ ΔF High end of specified range
- c. Perform steps f and g of Performance Test 5.

7. Start/CW Accuracy (EXT FM Function).

Procedure

- a. Perform steps a through d of Performance Test 5.
- b. Set 8690B controls as follows:
 - EXT FM Depressed
 - SWEEP SELECTOR CW
 - START/CW Low end of specified range
 - STOP/ ΔF High end of specified range
- c. Perform steps f and g of Performance Test 5.

8. Marker 1 - Start/CW Accuracy.

Procedure

- a. Perform steps a through d of Performance Test 5.
- b. Set 8690B controls as follows:
 - MARKER SWEEP Depressed
 - SWEEP SELECTOR CW
 - MARKER 1 High end of specified range
- c. Tune frequency meter to obtain maximum vertical displacement of oscilloscope display. Note and record any difference in frequency reading between frequency and MARKER 1 dial indicator. Repeat for MARKER 1, MARKER 2 at low end of specified range.
- d. TEST LIMIT: The MARKER 1 dial indicators and the frequency meter agree to within the applicable RF Unit Frequency Accuracy specifications listed in Table 1-1.

9. Marker 2 - Stop Accuracy.

Procedure

- a. Perform steps a through d of Performance Test 5.
- b. Set 8690B controls as follows:
 - MARKER SWEEP Depressed
 - SWEEP SELECTOR MANUAL
 - MARKER 2 High end of specified range
 - MANUAL SWEEP MAX CW
- c. Perform steps c and d of Performance Test 8.

10. Stop/ ΔF Accuracy (Start-Stop Function).

Procedure

- a. Perform steps a through d of Performance Test 5.
- b. Set 8690B controls as follows:
 - START/STOP Depressed
 - SWEEP SELECTOR MANUAL
 - MANUAL SWEEP MAX CW
 - STOP ΔF High end of specified range

(Continued)

TABLE 5-2. PERFORMANCE TESTS

c. Tune frequency meter to obtain maximum vertical displacement of oscilloscope display. Note and record any difference in frequency reading between frequency meter and STOP/ Δ F dial indicator. Repeat for STOP/ Δ F at low end of specified range.

d. TEST LIMIT: The STOP/ Δ F dial indicator and the frequency meter agree to within the applicable RF Unit Frequency Accuracy specifications listed in Table 1-1.

11. Marker 1 and Marker 2 Accuracy.

Procedure

a. Perform steps a through d of Performance Test 5. Add connection A, Figure 5-2.

b. Set 8690B controls as follows:

- Δ F Depressed
- SWEEP SELECTOR AUTO
- START/CW High end of specified range
- MARKER 1 High end of specified range
- MARKER 2 High end of specified range

c. Tune frequency meter to obtain maximum vertical displacement of oscilloscope display. Note and record any difference in frequency reading between frequency meter and START/CW, MARKER 1, and MARKER 2 dial indicators.

d. Repeat step c for START/CW, MARKER 1, and MARKER 2 set to the midpoint and then at end of specified range.

e. TEST LIMIT: The START/CW, MARKER 1, and MARKER 2 dial indicators and the frequency meter agree to within 1% of full scale for all RF Units.

12. Sweep Output and Sweep Ref Output Frequency Linearity.

Procedure

a. Connect equipment as shown in Figure 5-2, according to RF Unit model used. Omit connections A, B, and C. Omit directional detector or directional coupler-crystal detector combination at RF output.

b. Set RF Unit controls as follows:

- POWER LEVEL MAX CW
- ALC (Option 01) Not applicable

c. Set 8690B controls as follows:

- START/CW Low end of specified range
- STOP/ Δ F High end of specified range
- START-STOP Depressed
- SWEEP SELECTOR MANUAL
- ALC Released
- MANUAL SWEEP MAX CCW
- LINE RF

d. Connect accurate dc digital voltmeter to SWEEP OUT connector.

e. With MANUAL SWEEP maximum CCW, note voltmeter reading. Record as V1.

f. With MANUAL SWEEP maximum CW, note voltmeter reading. Record as V2.

g. Calculate SWEEP OUT voltage change, V2-V1, equal to full frequency range sweep, Record as V3.

h. Divide V3 into a convenient number of steps (e.g., 10) and calculate the SWEEP OUT voltage equal to each step.

i. Divide the RF Unit frequency range into the same number of steps. Calculate the frequency that corresponds to each step.

j. Measure RF output frequency at each voltage step.

k. TEST LIMITS: RF output frequency and the calculated frequency agree to within the applicable RF Unit Frequency Accuracy specifications listed in Table 1-1.

l. Add connection A, Figure 5-2.

(Continued)

TABLE 5-2. PERFORMANCE TESTS

- m. Change 8690B controls as follows:
 SWEEP SELECTOR. AUTO
 SWEEP TIME(SEC). Suitable for display
- n. Adjust oscilloscope horizontal sensitivity for calibrated sweep (e. g., 10 cm).
- o. Set SWEEP SELECTOR to MANUAL.
- p. Adjust MANUAL SWEEP to set voltage at SWEEP OUT connector to voltage steps calculated in step h.
- q. At each step, mark dot position on oscilloscope graticule.
- r. Set SWEEP SELECTOR to AUTO.
- s. Tune frequency meter to position maximum vertical displacements over graticule marks. Note and record frequency meter reading for each setting.
- t. TEST LIMITS: Output voltage is proportional to RF frequency; $0 \pm 2V$. At low end of RANGE increasing $40 \pm 3V$ per octave.
- u. For Sweep Ref Output Frequency Linearity tests, repeat steps a through t using the RF Unit rear panel SWEEP REF OUTPUT connector.

13. Sweep Line Sync.

Procedure

- a. Connect SWEEP OUT connector to the vertical input of an oscilloscope set for internal sweeping synchronized with the ac line frequency.
- b. Set 8690 controls as follows:
 SWEEP SELECTOR AUTO
 SWEEP TIME (SEC)1 - .01
 SWEEP TIME VERNIER LINE SYNC
 LINE RF
- c. TEST REQUIREMENT: Waveform displayed by oscilloscope is synchronized with oscilloscope sweep.

14. Sweep Output.

Procedure

- a. Perform steps a and b of Performance Test 13.
- b. Measure period and amplitude of the ramp portion of the waveform displayed on the oscilloscope.
- c. TEST LIMITS: Ramp period is 10 ± 3 milliseconds. Ramp amplitude is $15V \pm 2$ volts. SWEEP OUT should be activated for START-STOP, MARKER and ΔF sweep functions with AUTO, MANUAL or TRIG modes. SWEEP OUT amplitude should not change with sweep time, sweep direction, or sweep width.

15. Sweep Ref Output.

Procedure

- a. Perform steps a and b of Performance Test 13, using the SWEEP REF OUTPUT connector.
- b. Measure voltage limits of the linear ramp portion of the displayed waveform.
- c. TEST LIMITS: For a full specified frequency range sweep, ramp voltage limits are $0 \pm 2V$ at the low end of range, increasing approximately $40 \pm 3V$ per octave. SWEEP REF OUTPUT is activated for all sweep modes and functions.

16. AM Sensitivity.

Procedure

- a. Connect equipment as shown in Figure 5-1, according to RF Unit model used. Omit connections to oscilloscope.

(Continued)

TABLE 5-2. PERFORMANCE TESTS

- b. Set RF Unit controls as follows:
POWER LEVEL MAX CW
ALC (Option 01) EXT
- c. Set 8690 controls as follows:
ALC Released
START/CW Low end of specified range
SWEEP SELECTOR CW
LINE RF
- d. Note power meter reading with connection A omitted, Figure 5-1.
- e. Connect dc voltage source to EXT AM input, shown as connection A, Figure 5-1. Depress EXT AM pushbutton.
- f. TEST LIMIT: Power output decreases at least 30 dB from the level measured in step d.

17. Internal Square Wave AM and AM Frequency Response.

Procedure

- a. Connect equipment as shown in Figure 5-3 to include power meter and thermistor mount. Omit connections A, B, and D. If Option 01 RF Unit is used, omit connections C, and directional detector or directional coupler-crystal detector combination at RF output.
- b. Set RF Unit controls as follows:
POWER LEVEL MAX CW
ALC (Option 01) INT
- c. Set 8690B controls as follows:
ALC Released
SWEEP TIME (SEC) 100 - 10
INT SQ WAVE Depressed
START/CW Midpoint of specified range
START-STOP Depressed
LINE RF
SWEEP SELECTOR CW
- d. Use oscilloscope sweep time calibration to measure square wave frequency. Rotate INT SQ WAVE FREQ from maximum CW to maximum CCW. Repeat for all sweep times.
- e. TEST LIMIT: Square wave frequency range is \geq 950 to 1050 Hz.
- f. Use power meter to measure on/off ratio. Turn square wave off and read maximum leveled output power.
- g. Rotate POWER LEVEL maximum CCW and note power meter reading.
- h. TEST LIMIT: On/off ratio is \geq 20 dB at maximum leveled output.
- i. To check internal square wave AM under leveled conditions, repeat steps c through e with ALC pushbutton depressed and RF Unit POWER LEVEL set for maximum leveled power output.
- j. Include connection B, Figure 5-3.
- k. Set 8690B controls as follows:
ALC Released
SWEEP TIME (SEC) 100 - 10
SWEEP SELECTOR CW
START/CW Midpoint of specified range
EXT AM Depressed
- l. Monitor square wave generator with oscilloscope. Set frequency to 1000 Hz. Set amplitude to 10 volts peak-to-peak.
- m. Remove connection B from oscilloscope. Substitute connection A in place of power meter and thermistor mount.
- n. Connect in parallel with the oscilloscope vertical input a resistance which gives minimum decay time and overshoot for the displayed square wave. Use the smallest value of resistance that will obtain a suitable oscilloscope display; typically between 50 and 2000 ohms. Larger resistance increases rise time.

(Continued)

TABLE 5-2. PERFORMANCE TESTS

- o. Set START/CW to output frequency at which detected square wave display shows maximum rise and decay times.
- p. TEST LIMIT: (Unleveled power output.) Maximum rise and decay times for input frequencies as follows:

8691A through 8694A, Option 100	2.0 μ sec	DC - 500 kHz
8695A through 8697A	3.0 μ sec	DC - 750 kHz
8691B through 8694B including Options 100 and 200	1.0 μ sec	DC - 1 MHz
- q. To check External AM Frequency Response under leveled conditions, repeat steps j through o with ALC pushbutton depressed and RF Unit POWER LEVEL set for maximum leveled power output.
- r. TEST LIMITS: (Leveled power output.) Maximum rise and decay times for input frequencies as follows:

8691A through 8694A, including Option 100	15.0 μ sec	DC - 75 kHz
8695A through 8697A	20.0 μ sec	DC - 50 kHz
8691B through 8694B, including Options 100 and 200	10.0 μ sec	DC - 100 kHz

18. Residual AM.

Procedure

- a. Connect equipment as shown in Figure 5-1, according to RF Unit model used. Omit power meter and connection C. Substitute connections B and associated equipment.
- b. Set 8690B for CW operation, any frequency.
- c. Depress INT SQ WAVE pushbutton.
- d. Vary RF Unit POWER LEVEL to obtain -28 dB reading on AC voltmeter.
- e. Release INT SQ WAVE pushbutton.
- f. TEST LIMIT: Voltmeter reading decreases at least 32 dB (e.g., to -60 dB). Due to voltmeter response to a square wave and crystal detector square law response, a 32 dB reduction in reading equals a 40 dB reduction in signal level.

19. External FM Frequency Response and Sensitivity.

Procedure

- a. Connect equipment as shown in Figure 5-2, according to RF Unit Model used. Include connection C. Omit connections A and B.
- b. Set RF Unit controls as follows:

POWER LEVEL	As required
ALC (Option 01)	EXT
- c. Set 8690B controls as follows:

EXT FM	Depressed
AMPLITUDE MOD pushbutton	All Released
ALC	Released
SWEEP SELECTOR	CW
START/CW	Midpoint of specified range
LINE	RF
- d. With audio oscillator, apply known sine wave voltage to EXT FM input.
- e. (Unleveled power output.) Measure frequency response and voltage sensitivity at both the high and low ends of the specified range.
- f. (Leveled power output.) For standard RF Units, add connection B. Figure 5-2. For Option 001 RF Units, set ALC switch to INT, depress ALC button, and adjust for maximum leveled power.
- g. TEST LIMITS: Frequency Response: dc to 3 kHz. Sensitivity: deviation from CW setting approximately 6% of specified frequency range per volt.

20. Penlift.

Procedure

- a. Connect an ohmmeter to measure resistance between the rear-panel PENLIFT terminals. (Continued)

TABLE 5-2. PERFORMANCE TESTS

- b. Set 8690B for full frequency range auto sweep, sweep time range 100-10 seconds. Ohmmeter should register short circuit between PENLIFT terminals when SWEEP is lighted, open circuit when SWEEP is not lighted.
- c. Repeat step b with 10-1 second sweep time range.
- d. Repeat steps b and c with SWEEP SELECTOR at TRIG.
- e. Ohmmeter should register an open circuit between the PENLIFT terminals when the SWEEP SELECTOR is set to any position except AUTO or TRIG and when SWEEP TIME (SEC) is set to any position except 100-10 and 10-1.

21. Blanking Output.

Procedure

- a. Use an oscilloscope to test for a blanking signal at the rear-panel BLANKING output. The blanking signal is a rectangular -3 to -5 volt pulse coincident with the RF-off interval between sweeps. Blanking pulses should be present at the BLANKING output during AUTO and TRIG sweeps whether or not the BLANKING switch is set to ON. The BLANKING switch disables only RF output blanking. For oscilloscope display of the blanking pulse when the BLANKING switch is at OFF, terminate the oscilloscope vertical input with approximately 1000 ohms.

22. Marker Output.

Procedure

- a. Use an oscilloscope to test for Marker signals at the rear-panel MARKER output. The marker signals are narrow, triangular, -4 to -6 volt pulses coincident with the RF-modulating frequency markers. MARKER output is activated by the MARK 1 and MARK 2 pushbuttons with the START STOP, ΔF and EXT FM sweep functions. No marker pulses are available with MARKER SWEEP. The front-panel MARKER AMPLitude control varies the amplitude of the RF-modulating marker pulses, but does not affect pulse amplitude at the MARKER output.

23. Frequency Stability with Power Level Change.

Because time-varying magnetic fields of transformers and electric motors (especially cooling fan motors) can frequency modulate the backward wave oscillator, do NOT operate these devices close to the Sweep Oscillator.

Procedure

- a. Connect equipment as shown in Figure 5-2, according to RF Unit used. Omit connections A, B to oscilloscope, and C.
- b. Set RF Unit controls as follows:
ALC (Option 001) EXT
- c. Set 8690 controls as follows:
ALC Depressed
AM pushbuttons..... All Released
SWEEP SELECTOR..... CW
START CW High end of specified range
LINE RF
- d. Adjust POWER LEVEL for maximum leveled power.
- e. Tune frequency meter for optimum vertical deflection on oscilloscope. Note and record frequency reading.
- f. Connect equipment as shown in Figure 5-1 to include power meter and thermistor mount. Omit connection B and connection to oscilloscope.
- g. Reduce power levels according to RF Unit used as follows:
8691-7A, 8694A Options 100 and 200 6 dB
8691-4B, 8692-4B Option 100, 8694B Option 100 10 dB

(Continued)

TABLE 5-2. PERFORMANCE TESTS

- h. Repeat steps a and e.
- i. TEST LIMITS: Output frequency varies less than applicable limit listed below:
 - 8691A Typically < 20 MHz
 - 8691B, ±500 kHz
 - 8692B, 8692B Option 100 ±4 MHz
 - 8692A Typically < 40 MHz
 - 8693A Typically < 80 MHz
 - 8693B, 8693B Option 100, 8694B,
8694B Options 100 & 200 ±1 MHz
 - 8694A Typically < 160 MHz
 - 8695A ±10 MHz
 - 8696A ±15 MHz
 - 8697A ±20 MHz

24. Frequency Stability with Line Voltage Changes.

Procedure

- a. Connect equipment as shown in Figure 5-2, according to RF Unit used. Omit connections A, B, and C. Set 8690B for CW operation, any frequency.
- b. Set line voltage to 115 Vac with adjustable transformer in primary power circuit.
- c. Wait 2 minutes for stabilization, then tune frequency meter for maximum vertical deflection of oscilloscope display. Note frequency meter reading.
- d. Set line voltage to 103 Vac and repeat step c.
- e. Set line voltage to 127 Vac and repeat step c.
- f. TEST LIMIT: The frequency meter reading obtained at 115 Vac should not differ from the readings at 103 Vac and 127 Vac by more than applicable limit listed below.
 - 8691A, B, 8692A/B (including Option 100)..... ±500 MHz
 - 8693A, B, 8694A/B (including Options 100 and 200).... ±1 MHz
 - 8695A ±10 MHz
 - 8696A ±15 MHz
 - 8697A ±20 MHz

25. Spurious Signals.

Procedure

- a. Connect spectrum analyzer directly to RF Unit RF output.
- b. Set RF Unit controls as follows:
 - POWER LEVEL MAX CW
 - ALC (Option 001) EXT
- c. Set 8690 controls as follows:
 - AM pushbuttons All Released
 - SWEEP SELECTOR..... CW
 - ALC Released
- d. Manually tune 8690 thru specified RF Unit frequency range.
- e. Note amplitude of harmonics and other spurious outputs relative to sweep oscillator fundamental.
- f. TEST LIMIT: Harmonics, at least 20 dB below CW output; non-harmonics at least 40 dB below CW output.

(Continued)

TABLE 5-2. PERFORMANCE TESTS

26. Residual FM (For RF Units up to 12.4 GHz).

Because time-varying magnetic fields of transformers and electric motors (especially cooling fan motors) can frequency modulate the backward wave oscillator, do NOT operate these devices close to the Sweep Oscillator.

Procedures

a. Connect RF Unit output to microwave frequency converter input. Connect frequency converter discriminator output (FM/APC output) to oscilloscope vertical input. Set oscilloscope to internal sweep. Connect .015 μ F capacitor across discriminator output to obtain 10 kHz bandwidth.

b. Set 8690 controls as follows:

ALC	Released
AM pushbuttons	All Released
SWEEP SELECTOR	CW
START/CW	Low end of specified range
LINE	RF

c. Set RF Unit controls as follows:

POWER LEVEL	As required for optimum converter operation
-------------------	---

d. Amplitude of oscilloscope display is residual FM deviation. Using oscilloscope vertical sensitivity and the frequency converter discriminator output sensitivity, calculate pk residual FM. For example; with oscilloscope vertical sensitivity at 50 mV/cm and frequency converter output sensitivity at 5V/MHz, 1 cm oscilloscope deflection = 10 kHz deviation.

e. Repeat test at middle and high end of band.

f. TEST LIMIT: Residual FM is less than applicable limit listed below. (For RF Units with serial prefix below 835-, refer to RF Unit Manual for specifications.)

8691A, 8692A	< 30 kHz pk
8691B	< 10 kHz pk
8692B, 8693B, 8694B	< 15 kHz pk
8693A	< 50 kHz pk
8692B Option 100, 8694B Option 100, 8694B Option 200	< 20 kHz pk
8694A, 8694A Option 100, 8694A Option 200	< 60 kHz pk

27. Residual FM (For RF Units above 12.4 GHz).

Because time-varying magnetic fields of transformers and electric motors (especially cooling fan motors) can frequency modulate the backward wave oscillator, do NOT operate these devices close to the Sweep Oscillator.

Procedure

a. Connect spectrum analyzer to RF Unit output.

b. Set 8690 controls as follows:

ALC	Released
AM pushbuttons	All Released
SWEEP SELECTOR	CW
START/CW	Low end of specified range
LINE	RF

c. Set RF Unit controls as follows:

POWER LEVEL	MAX CW
ALC (Option 01)	EXT

d. Width of spectrum analyzer display at 3 dB points is equal to the peak-to-peak frequency deviation of the RF output ($\pm 30\%$).

e. Repeat test at middle and high end of band.

f. TEST LIMIT: Residual FM is less than applicable limit listed below:

8695A	< 150 kHz pk
8696A	< 200 kHz pk
8697A	< 350 kHz pk

RF UNIT MODELS
 8691A/B 8692B OPTION 100
 8692A/B 8693B OPTION 100
 8693A/B
 8694A/B

NOTE:
 WHERE POSSIBLE MAKE DIRECT
 CONNECTIONS WITHOUT CABLES

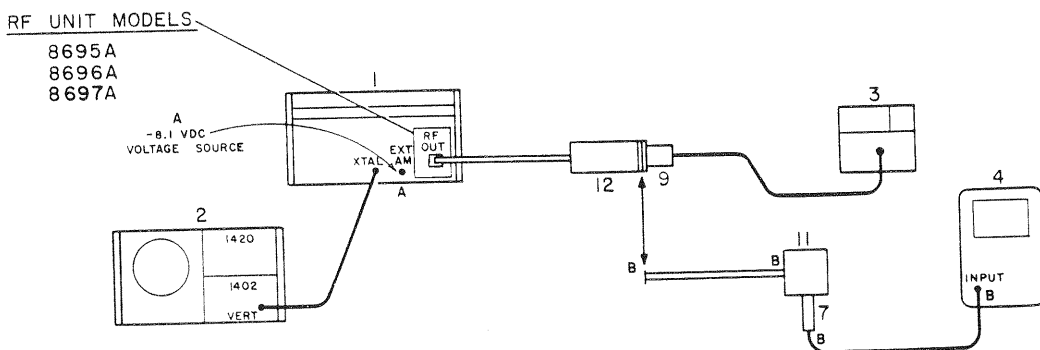
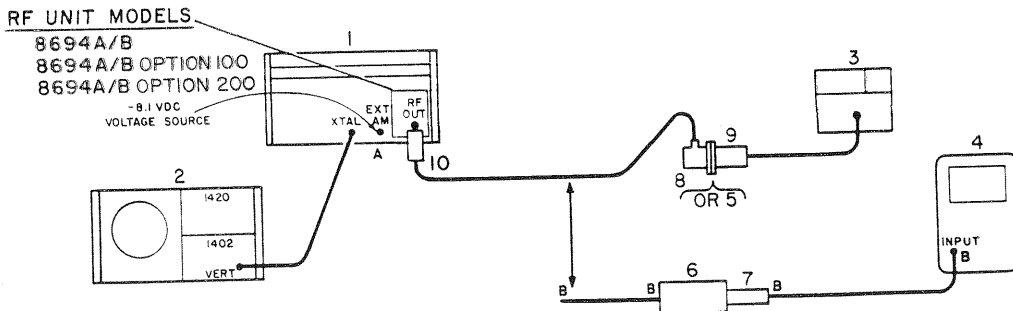
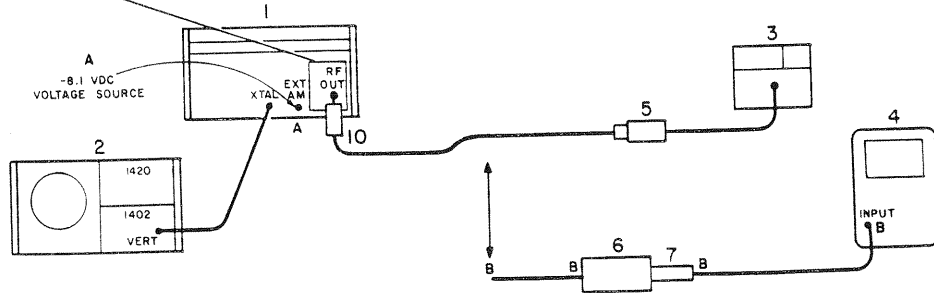

1. SWEEP OSCILLATOR *hp* 8690
2. OSCILLOSCOPE *hp* 140
3. POWER METER *hp* 431
4. AC VOLTMETER *hp* 400
5. THERMISTOR MOUNT *hp* 8478
6. CRYSTAL DETECTOR *hp* 423
7. 100 OHM LOAD RESISTOR *hp* 11523 (*hp* 422, 423, 424 Option 02)
8. COAXIAL TO WAVEGUIDE ADAPTER *hp* X281
9. THERMISTOR MOUNT *hp* X486
10. ATTENUATOR *hp* 8491 — As required to reduce power to thermistor mount to less than 10 mW.
11. CRYSTAL DETECTOR: 8695A use P424 Option 02
 8696A use K422 Option 02
 8697A use R422 Option 02
12. PRECISION VARIABLE ATTENUATOR *hp* 382 — As required to reduce power at 486 to less than 10 mW.
 8695A requires P382 and P486
 8696A requires K382 and K 3
 8697A requires R382 and R486

Figure 5-1. Maintenance Equipment Setup Number 1

RF UNIT MODELS

8691A/B 8692B OPTION 100
8692A/B 8693B OPTION 100
8693A/B 8694A/B OPTION 100
8694A/B OPTION 200

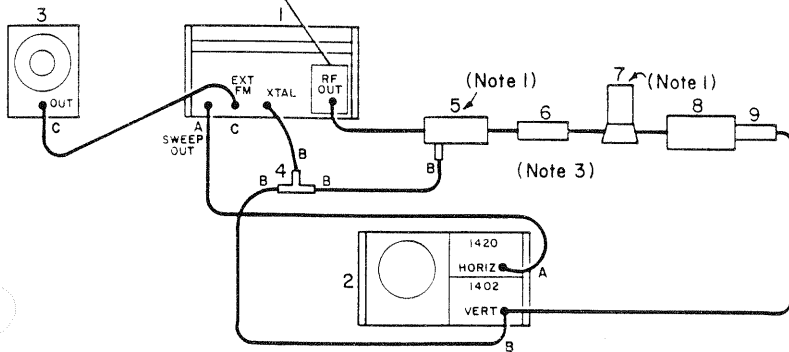

NOTES

1. Use the appropriate equipment

RF UNIT	DIRECTIONAL DETECTOR	FREQUENCY METER
8691A/B	hp 786	hp 536
8692A/B	787	536
8692B OPTION 100	787	536
8693A/B	788	537
8693B OPTION 100	788	537
8694A/B OPTION 100	Narda 22440 with hp 423 Crystal Detector	537
8694A/B OPTION 200		537
8694A/B		

RF UNIT MODELS

8694A/B

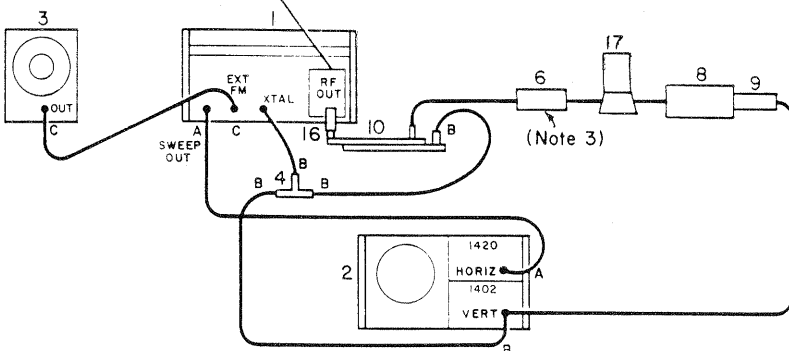

2. Use the appropriate equipment

RF UNIT	DIRECTIONAL COUPLER	CRYSTAL DETECTOR
8695A	P 752	P 424*
8696A	K 752	K 422*
8697A	R 752	R 422*

*Option 02 for Crystal Detector No. 14

RF UNIT MODELS

8695A
8696A
8697A

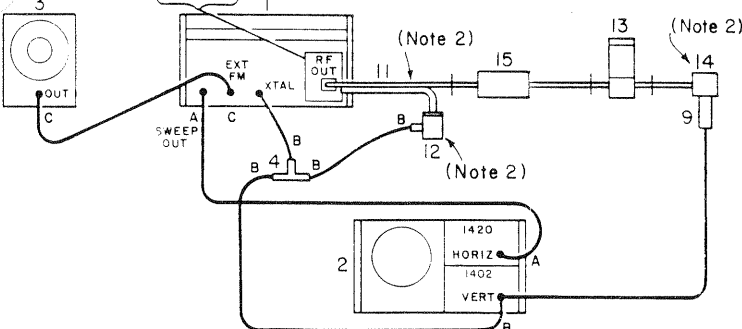

3. As required to reduce power to Crystal Detector to less than 100mW

NOTE:
WHERE POSSIBLE MAKE DIRECT CONNECTIONS WITHOUT CABLES

- | | |
|--|--|
| 1. SWEEP OSCILLATOR hp 8690A | 10. DIRECTIONAL DETECTOR hp 789 |
| 2. OSCILLOSCOPE hp 140 | 11. DIRECTIONAL COUPLER hp 752 (Refer to Note 2) |
| 3. AUDIO OSCILLATOR hp 200 SERIES | 12. CRYSTAL DETECTOR (Refer to Note 2) |
| 4. BNC TEE CONNECTOR | 13. FREQUENCY METER hp 532 |
| 5. DIRECTIONAL DETECTOR (Refer to Note 1) | 14. CRYSTAL DETECTOR (Refer to Note 2) |
| 6. ATTENUATOR hp 8491 | 15. WAVEGUIDE ATTENUATOR hp 370, 375 (Refer to Note 3) |
| 7. FREQUENCY METER (Refer to Note 1) | 16. MALE N to MALE N ADAPTER |
| 8. CRYSTAL DETECTOR hp 423 | 17. FREQUENCY METER hp 537 |
| 9. 100 OHM LOAD RESISTOR hp 11523 (hp 422, 423, 424 Option 02) | |

Figure 5-2. Maintenance Equipment Setup Number 2

RF UNIT MODELS
 8691A/B 8692B OPTION 100
 8692A/B 8693B OPTION 100
 8693A/B 8694A/B OPTION 100
 8694A/B OPTION 200

NOTES

1. Use the appropriate equipment

RF UNIT	DIRECTIONAL DETECTOR
8691A/B	hp 786
8692A/B	787
8692B OPTION 100	787
8693A/B	788
8693B OPTION 100	788
8694A/B OPTION 100	Narda 22440 with hp 423 Crystal Detector
8694A/B OPTION 200	

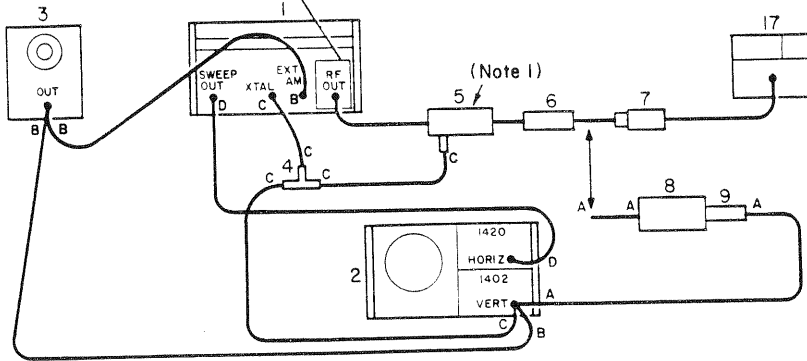

RF UNIT MODELS

8694A/B

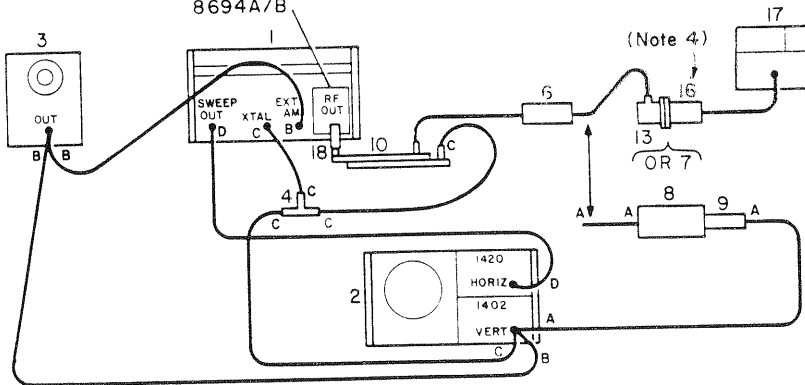

2. Use the appropriate equipment

RF UNIT	DIRECTIONAL COUPLER	CRYSTAL DETECTOR
8695A	P 752	P424*
8696A	K 752	K422*
8697A	R 752	R422*

*Option 02 for Crystal Detector No. 14

NOTE:
WHERE POSSIBLE MAKE DIRECT CONNECTIONS WITHOUT CABLES

RF UNIT MODELS

8695A, 8696A,
8697A

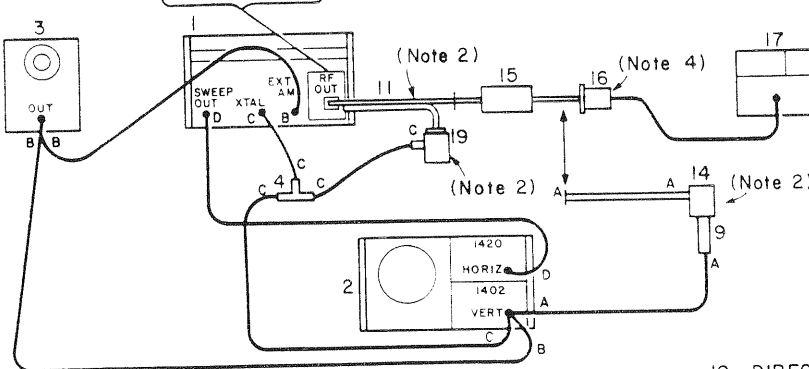

3. As required to reduce power to Crystal Detector to less than 100mW, or reduce power to Thermistor Mount to less than 10mW.

4. 8694A/B requires X486
 8695A requires P486
 8696A requires K486
 8697A requires R486

- 1. SWEEP OSCILLATOR hp8690
- 2. OSCILLOSCOPE hp140
- 3. SQUARE WAVE GENERATOR hp211
- 4. BNC TEE CONNECTOR
- 5. DIRECTIONAL DETECTOR (Refer to Note 1)
- 6. ATTENUATOR hp8491 — (Refer to Note 3)
- 7. THERMISTOR MOUNT hp8478
- 8. CRYSTAL DETECTOR hp423
- 9. 100 OHM LOAD RESISTOR hp11523 (hp422,423,424 Option 02)
- 10. DIRECTIONAL DETECTOR hp789
- 11. DIRECTIONAL COUPLER hp752 (Refer to Note 2)
- 12. CRYSTAL DETECTOR (Refer to Note 2)
- 13. COAXIAL TO WAVEGUIDE ADAPTER hp X 281
- 14. CRYSTAL DETECTOR (Refer to Note 2)
- 15. WAVEGUIDE ATTENUATOR hp 370, 375 (Refer to Note 3)
- 16. THERMISTOR MOUNT hp486 (Refer to Note 4)
- 17. POWER METER hp431
- 18. MALE N to MALE N ADAPTER
- 19. CRYSTAL DETECTOR (Refer to Note 2)

Figure 5-3. Maintenance Equipment Setup Number 3

Table 5-3. Test Equipment Required for Adjustments and/or Troubleshooting

Test Instrument	Critical Specifications	Recommended Model
All instruments in Table 5-1		
DC Voltmeter	Range: 0 to $\pm 300V$ Accuracy: $\pm 0.03\%$ minimum Input Impedance: 10 megohms	HP405BR HP 3460B
Clip-On DC Ammeter	Range: 10 ma to 5 amps Accuracy: $\pm 5\%$	hp 428
DC Voltmeter*	Range: 100 to $+2200V$ Accuracy: $\pm 3\%$ Input Impedance: 20K ohms/volt	Simpson Model 260
Capacitor**	Capacitance: 0.01 μfd VDCW: 2000	

*For BWO tube helix, collector voltage measurement. Must be capable of "floating" meas.
**DC block for BWO tube helix voltage ripple measurement.

5-16. ADJUSTMENTS.

5-17. **PURPOSE.** The adjustment procedures given in Table 5-4 include instructions to set the dc operating voltages and calibrate the 8690B tuning functions. The procedures are independent of circuit functions included in the 8690 series RF Units. Adjustment procedures that apply to the RF Unit circuit functions are given in the manual provided with the particular RF Unit used.

5-18. The adjustments made without the RF Unit installed are designed to: (1) establish the correct sequence of adjustments in their order of basic relationship to overall circuit functions in both the 8690B and the RF Unit used, (2) ensure interchangeability of all RF Units with the 8690B, and (3) assist troubleshooting analysis by isolating the functions of circuits included in the RF Unit.

5-19. The adjustments in Table 5-4 are to be performed with the RF Unit removed from the 8690B. Figure 5-5 shows a rear view of connectors J11 and J12 which connect to the RF Unit. Some adjustments require connections to particular pins of these connectors. Table 5-3 lists test equipment required for adjustments and/or troubleshooting.

5-20. Perform the adjustments given in Table 5-4 in the order listed. Do not perform adjustments on an RF Unit, or on the 8690B with an RF Unit installed until the requirements of each adjustment in Table 5-4 are satisfied. If a requirement cannot be satisfied, refer to the troubleshooting paragraphs. After completing the adjustments of Table 5-4, proceed to the adjustments given in the manual provided with the particular RF Unit used.

5-21. **ADJUSTMENT CONTROL SETTINGS.** Unless otherwise specified, set the 8690B controls for all adjustments as follows:

- LINE RF
- START/CW
- MARKER 1 - START/CW
- MARKER 2 - STOP
- STOP/ ΔF
- SWEEP SELECTOR CW
- FUNCTION pushbuttons All released
- AMPLITUDE MOD pushbuttons All released
- ALC Released
- MANUAL SWEEP MAX CCW
- SWEEP TIME (SEC). 100-10
- VERNIER LINE SYNC
- INT SQ WAVE FREQ MAX CCW
- BLANKING OFF
- ALL BNC INPUTS and OUTPUTS . . . No connection

5-22. POWER SUPPLY ADJUSTMENTS.

5-23. There are four major causes of out-of-tolerance power supply voltages: (1) maladjustment, (2) excessive current drawn by the load, (3) low line voltage, and (4) defective component in the power supply. Only in the first case should the power supply be adjusted. For each of the other causes, repair of the malfunction will likely restore the output voltage within tolerance. Reset a slightly out-of-tolerance supply voltage only if improved frequency calibration results.

5-24. Perform power supply adjustments only if proven by accurate measurement to be significantly outside the tolerances specified, and only if the voltage error is not caused either by excessive current being drawn through the regulator or by inadequate voltage being supplied to the regulator from the power supply rectifiers.

NOTE

The following adjustments are to be made without an RF Unit installed in the 8690B. Adjustment procedures requiring an RF Unit are given in the manual provided with the RF Unit used.

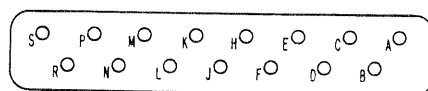

Figure 5-4. Pin Locations on Connector J11

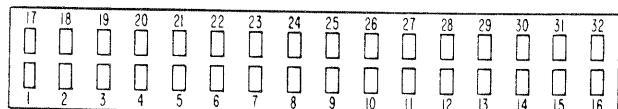

Figure 5-5. Pin Locations on Connector J12

TABLE 5-4. ADJUSTMENTS

NOTE
ALLOW 30 MINUTES WARM UP.

1. Power Supply.

Procedure

- a. Install RF Unit in 8690B.
- b. Connect 3460 Voltmeter (Table 5-3) from A5TP1 to 8690B chassis ground.
- c. Adjust A5R7 for -300 ± 0.1 Vdc.
- d. Connect 3460 Voltmeter from A14TP4 to 8690B chassis ground.
- e. Adjust A14R16 for -6.30 ± 0.05 Vdc.
- f. Connect 3460 Voltmeter from A5TP2 to 8690B chassis ground.
- g. Adjust A5R27 for $+275 \pm 0.2$ Vdc.
- h. Connect 3460 Voltmeter from A14TP3 to 8690B chassis ground.
- i. Adjust A14R21 for $+20 \pm 0.1$ Vdc.

2. Sweep Calibration: Ramp Amplitude.

Procedure

- a. Remove RF Unit from 8690B.
- b. Set 8690B controls as follows:
 SWEEP SELECTOR CW
 START/CW High end of specified range, any RF Unit
- c. Connect 3460 Voltmeter (Table 5-3) from Test Point 4 on Helix Amplifier Assembly A4 to 8690B chassis ground.
- d. Adjust A3R75 73 V Ramp Adj for $+73.00 \pm 0.01$ Vdc.

3. Sweep Calibration: Ramp Zero.

Procedure

- a. Remove RF Unit from 8690B
- b. Set 8690B controls as follows:
 SWEEP SELECTOR MANUAL
 MANUAL SWEEP MAX CW
- c. Connect 3460 Voltmeter (Table 5-3) probe from Test Point 3 on Reciprocal Amplifier Assembly A3 to 8690B chassis ground.
- d. Adjust A3R53 RAMP ZERO ADJ, for 0.0 ± 0.01 Vdc.

(Continued)

TABLE 5-4. ADJUSTMENTS

4. Sweep Calibration: Reciprocal Zero.

Procedure

- a. Remove RF Unit from 8690B.
- b. Set 8690B controls as follows:
SWEEP SELECTOR MANUAL
MANUAL SWEEP MAX CCW
- c. Connect 3460 Voltmeter (Table 5-3) probe from Test Point 7 on Reciprocal Amplifier Assembly A3 to 8690B chassis ground.
- d. Adjust A3R50 RECIPROCAL ZERO for 0.00 ± 0.01 Vdc.

5. Frequency Control Calibration; Low End.

Procedure

- a. Remove RF Unit from 8690B.
- b. Set 8690B controls as follows:
START CW
MARKER 1 - START/CW
MARKER 2 - STOP
STOP ΔF
FUNCTION START-STOP
SWEEP SELECTOR CW
} Low end of specified range, any RF Unit
- c. Connect 3460 Voltmeter (Table 5-3) from Test Point 4 on Helix Amplifier Assembly A4 to 8690B chassis ground.
- d. Adjust A1R1, START LOW FREQ ADJ. for $+3.0 \pm 0.01$ Vdc.
- e. Change 8690B controls as follows:
FUNCTION MARKER SWEEP
- f. Adjust A1R2, MARKER SWEEP START LOW FREQ ADJ. for $+3.00 \pm 0.01$ Vdc.
- g. Change 8690B controls as follows:
SWEEP SELECTOR MANUAL
MANUAL SWEEP FULL CW
- h. Adjust A1R3, MARKER SWEEP STOP LOW FREQ ADJ. for $+3.00 \pm 0.01$ Vdc.
- i. Change 8690B controls as follows:
FUNCTION START-STOP
- j. Adjust A1R4, STOP LOW FREQ ADJ. for $+3.00 \pm 0.01$ Vdc.

(Continued)

TABLE 5-4. ADJUSTMENTS

6. Helix Feedback Amplifier Gain.

Procedure

- a. Install RF Unit 8690B.
- b. Connect 3460 Digital Voltmeter from A1TP1 in RF Unit to 8690B chassis ground.
- c. Adjust A4R32, HELIX FEEDBACK ZERO ADJ for 0 ± 0.01 Vdc.

7. Marker Calibration; Low End.

Procedure

- a. Remove RF Unit from 8690B.
- b. Set 8690B controls as follows:

SWEEP SELECTOR	MANUAL	
MANUAL SWEEP	MAX CCW	
AMPLITUDE MOD	MARK 1,	
MARKER 1	}	 Low end of specified range, any RF Unit
MARKER 2			
- c. Connect oscilloscope (Table 5-1) from A11TP4 to 8690B chassis ground.
- d. Adjust A11R18, MARKER 1 LF ADJ, for spot dip on oscilloscope display.
Reset 8690B controls

MANUAL SWEEP	MAX CW
AMPLITUDE MOD	MARK 2
RELEASE	MARK 1
- e. Adjust A11R2, MARKER 2 LF ADJ, for spot dip on oscilloscope display.

8. Frequency Control Calibration; High End.

Procedure

- a. Remove RF Unit from 8690B.
- b. Set 8690B controls as follows:

START CW	}	 High end of specified range, any RF Unit
MARKER 1 - START CW			
MARKER 2 - STOP			
STOP ΔF			
FUNCTION	START-STOP	
SWEEP SELECTOR	MANUAL	
MANUAL SWEEP	MAX CW	
EXT FM BNC connector	place short from 8690B chassis ground to inner conductor	
- c. Connect 3460 Voltmeter (Table 5-3) from Test Point 4, Helix Amplifier Assembly A4, to 8690B chassis ground.
- d. Adjust A2R24, STOP HF ADJ, for $+73.00 \pm 0.01$ Vdc.
- e. Change 8690B controls as follows:

FUNCTION	MARKER SWEEP
----------	-------	--------------
- f. Adjust A2R30, MARKER SWEEP STOP HF ADJ, for $+73.00 \pm 0.01$ Vdc.
- g. Change 8690B controls as follows:

SWEEP SELECTOR	CW
----------------	-------	----
- h. Adjust A2R22, MARKER SWEEP START HF ADJ, for $+73.00 \pm 0.01$ Vdc.

(Continued)

TABLE 5-4. ADJUSTMENTS

- i. Change 8690B controls as follows:
FUNCTION ΔF
- j. Adjust A2R19, ΔF CW ADJUST, for $+73.00 \pm 0.01$ Vdc.
- k. Change 8690B control as follows:
FUNCTION EXT FM
- l. Adjust A2R38 EXT FM ZERO ADJ, for $+73.00 \pm 0.01$ Vdc. Wait at least 3 minutes to allow reciprocal amplifier to stabilize before adjusting A2R38.
- m. Remove short from EXT FM BNC connector.

9. Marker Calibration; High End.

Procedure

- a. Remove RF Unit from 8690B.
- b. Set 8690B controls as follows:
FUNCTION START-STOP
SWEEP SELECTOR. CW
AMPLITUDE MOD. MARK 1,
- c. Connect oscilloscope (Table 5-1) from A11TP4 to 8690B chassis ground.
- d. Adjust A2R23, MARKER 1 HF ADJUST, for spot dip on oscilloscope display.

Reset 8690B controls
SWEEP SELECTOR MANUAL
MANUAL SWEEP FULL CW
RELEASE MARK 1 PRESS MARK 2

- e. Adjust A2R31, MARKER 2 HF ADJUST, for spot dip on oscilloscope display.

10. ΔF Calibration: ΔF Bandwidth.

Procedure

- a. Remove RF Unit from 8690B.
- b. Set 8690B controls as follows:
FUNCTION ΔF
SWEEP SELECTOR. MANUAL
START/CW 1.05 times the low end frequency of specified range,
any RF Unit
- c. Connect 3460 Voltmeter from Test Point 4, Helix Amplifier Assembly A4, to 8690B chassis ground.
- d. Rotate MANUAL SWEEP control from MAX CCW to MAX CW, and note voltmeter reading change.
- e. Adjust A2R25, ΔF BANDWIDTH ADJUST, for voltmeter reading change of 7.0 ± 0.1 Vdc.

11. ΔF Calibration: ΔF Center Frequency.

Procedure

- a. Remove RF Unit from 8690B.
- b. Set 8690B controls as follows:
FUNCTION START-STOP
SWEEP SELECTOR. MANUAL
START/CW Low end of specified range, any RF Unit
STOP/ ΔF High end of specified range, any RF Unit

(Continued)

TABLE 5-4. ADJUSTMENTS

- c. Connect 3460 Voltmeter from Test Point 4, Helix Amplifier Assembly A4, to 8690B chassis ground.
- d. Set MANUAL SWEEP control for voltmeter reading of $+38.0 \pm 0.01$ Vdc.
- e. Change 8690B controls as follows:
 FUNCTION ΔF
- f. Adjust A2R28, ΔF CENTER ADJUST, for $+3.00 \pm 0.01$ Vdc.

12. ΔF Calibration: ΔF Zero.

Procedure

- a. Remove RF Unit from 8690B.
- b. Set 8690B controls as follows:
 FUNCTION ΔF
 SWEEP SELECTOR. MANUAL
 START /CW }
 STOP / ΔF } Low end of specified range, any RF Unit
- c. Connect 3460 Voltmeter from Test Point 4, Helix Amplifier Assembly A4, to 8690B chassis ground.
- d. Rotate MANUAL SWEEP from MAX CCW to MAX CW, and note voltmeter reading change.
- e. Adjust A2R8, ZERO ΔF ADJ, so that voltmeter reading remains at $+3.00 \pm 0.01$ Vdc during step d.

13. ALC Balance.

Procedure

- a. Remove RF Unit from 8690B.
- b. Set 8690B controls as follows:
 FUNCTION START /STOP
 SWEEP SELECTOR. CW
 ALC Depressed
- c. Connect Test Points 3 and 2 on Assembly A12 together (bases of Q4B and Q4A respectively).
- d. Short front panel XTAL (ALC INPUT) connector to chassis ground.
- e. Connect 3440 Voltmeter between A12 Assembly Test Point 1 and chassis ground.
- f. Adjust A12R7 ALC BALANCE ADJ to full counter clockwise position, and note reading on voltmeter. Voltmeter reading should be approximately -5.6 Vdc.
- g. Adjust A12R7 ALC BALANCE ADJ clockwise through a dip (dip is 10 mV deep) until the voltage is the same as noted in preceding step.
- h. Remove connection between A12 Test Points 3 and 2, and ground short from XTAL connector.

Table 5-5. J11/J12 Connections to RF Unit

Note
Refer to Figure 7-1 for explanation of wire color code.

J11 Pin Designation	Wire Color	Description of Signal
A	SH 2	115 VAC. From T2 primary, pin 2. Other side of this primary is connected to J11, pin D.
B	SH 0	115 VAC. From T2 primary, pin 1. Other side of this primary is connected to J11, pin C.
C	SH 4	115 VAC. From T2 primary, pin 3. Other side of this primary is connected to J11, pin B.
D	SH 5	115 VAC. From T2 primary, pin 4. Other side of this primary is connected to J11, pin A.
E, F, H, J, K, L	-	Not used.
M	4	Helix Voltage. From A8 HV Power Supply ahead of K3 Helix Over-current Relay to helix voltage divider on RF Unit A1 Modulator Assy.
N	3	Collector Voltage. From A8 HV Power Supply A8V1 to COLLECTOR terminal on RF Unit A3 Terminal Assy.
P	2	Helix Voltage. From A8 HV Power Supply through K3 Helix Over-current Relay to HELIX terminal on RF Unit A3 Terminal Assy.
R	-	Not used.
S	924	From junction of S3 FUNCTION switch and A2R20; Tuning Voltage and Marker Combining (Summing) Circuits. To 8707 Preset Mode Adj.
J12 Pin Designation	Wire Color	Description of Signal
1	98	Anode Interlock. Jumpered to P12, pin 17 in RF Unit.
2	908	Supplies ground for 8699B RF Unit in CW.
3	945	Blanking Signal. From S13 BLANKING switch to "B" type RF Units grid blanking circuit (8691-4B RF Units above Serial Prefix 710-); Amplitude Modulation Section.
4	9	ALC Input Signal. From J4 XTAL ALC INPUT to Option 01 8691-4A B RF Units XTAL switch S1A. Used in conjunction with J12, pin 20.
5	90	ALC Common. From A12 ALC Amplifier to RF Unit A1 Modulator Assembly. Connected to 8690 chassis at J12.
6	0	RF Unit chassis ground. Connected to 8690 chassis at J12.
7	-	Not used.
8	0	Circuit Ground Interlock. Jumpered to P12, pin 24 in RF Unit. Connected to 8690 chassis at J12.

(Continued)

Table 5-5. J11/J12 Connections to RF Unit

J12 Pin Designation	Wire Color	Description of Signal
9	6	Anode Voltage: From A3V1B Cathode Follower to ANODE terminal on RF Unit A3 Terminal Assembly.
10	927	Same as J12, pin 16. Jumpered to pin 16 at J12.
11	902	+20 VDC Interlock. Jumpered to P12, pin 27 in RF Unit.
12	9	Tuning Voltage Ramp. From A4 Helix Amp to (1) RF Unit Sweep Reference Output Circuit, and (2) jumpered to P12, pin 28 for return to 8690A A4 Helix Amp Differential Amplifier A4V5.
13	91, 0	Filament ground connected to 8690 ground junction point at rear of A7. Connects to GND terminal of RF Unit A3 Terminal Assy. 91 is ground for DS1-DS9. 0 is ground for ground junction point.
14	5	AM Signal. From A2 Calibrator Assembly to RF Unit R2 POWER LEVEL control.
15	967	ALC Signal. From A11 Marker Assembly to RF Unit R1 POWER LEVEL control.
16	927	ALC Signal. From RF Unit R1 POWER LEVEL control to A12 ALC Amp Differential Amplifier A12Q1B.
17	98	Anode Interlock. Jumpered to P12, pin 1 in RF Unit.
18	-	Not used.
19	9	Anode Voltage. From RF Unit A1R42 ANODE ADJUST to Cathode Follower A3V1B input.
20	2	ALC Input Signal. From J4 XTAL ALC INPUT to Option 01 8691-4A/B RF Units XTAL switch S1A. Used in conjunction with J12, pin 4.
21	7	-300 VDC. From A9 Rectifier Assembly to RF Unit.
22	9	Helix Feedback Return. From RF Unit A2 Freq Shape Assy to A4 Helix Amp Differential Amp A4V2B.
23	92	+275 VDC. From A5 LV Power Supply to RF Unit.
24	0	Circuit Ground Interlock. Jumpered to P12, pin 8 in RF Unit.
25	-	Not used.
26	98	Same as J12 pin 32. Jumpered to pin 32 at J12.
27	902	+20 VDC Interlock. Jumpered to P12, pin 11 in RF Unit.
28	0	Tuning Voltage Ramp. Jumpered to J12, pin 12 in RF Unit. Return signal to 8690B A4 Helix Amp Differential Amplifier A4V5. In same shielded cable as wire to J12, pin 12.
29	1	-6.3 VDC. From A14 Heater Supply to RF Unit.
30	903	RF Level Set and Leveling Signals. From RF Unit ALC GAIN CIRCUIT to Amplitude Modulation Section.
31	95	ALC Signal. From Amplitude Modulation Section to (1) input of 8691-4B RF Unit ALC GAIN CIRCUIT UNLEVELED LAMP CIRCUIT, or (2) input of 8691-7A RF Unit UNLEVELED LAMP CIRCUIT P12, pin 30.
32	98	AM Signals and Level Set Bias. From Amplitude Modulation Section to (1) 8691-4B RF Unit A4 PIN Modulator, or (2) input to 8691-7A RF Unit GRID MODULATOR CIRCUIT.

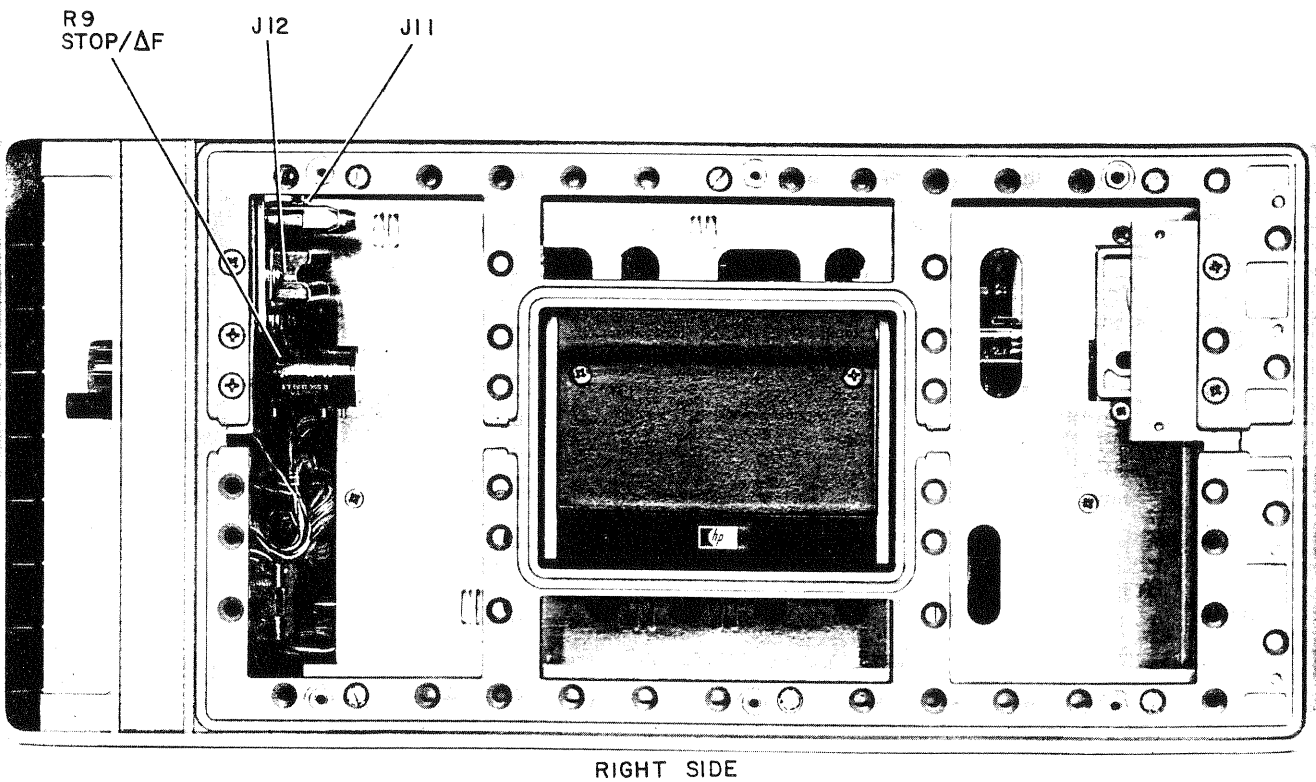
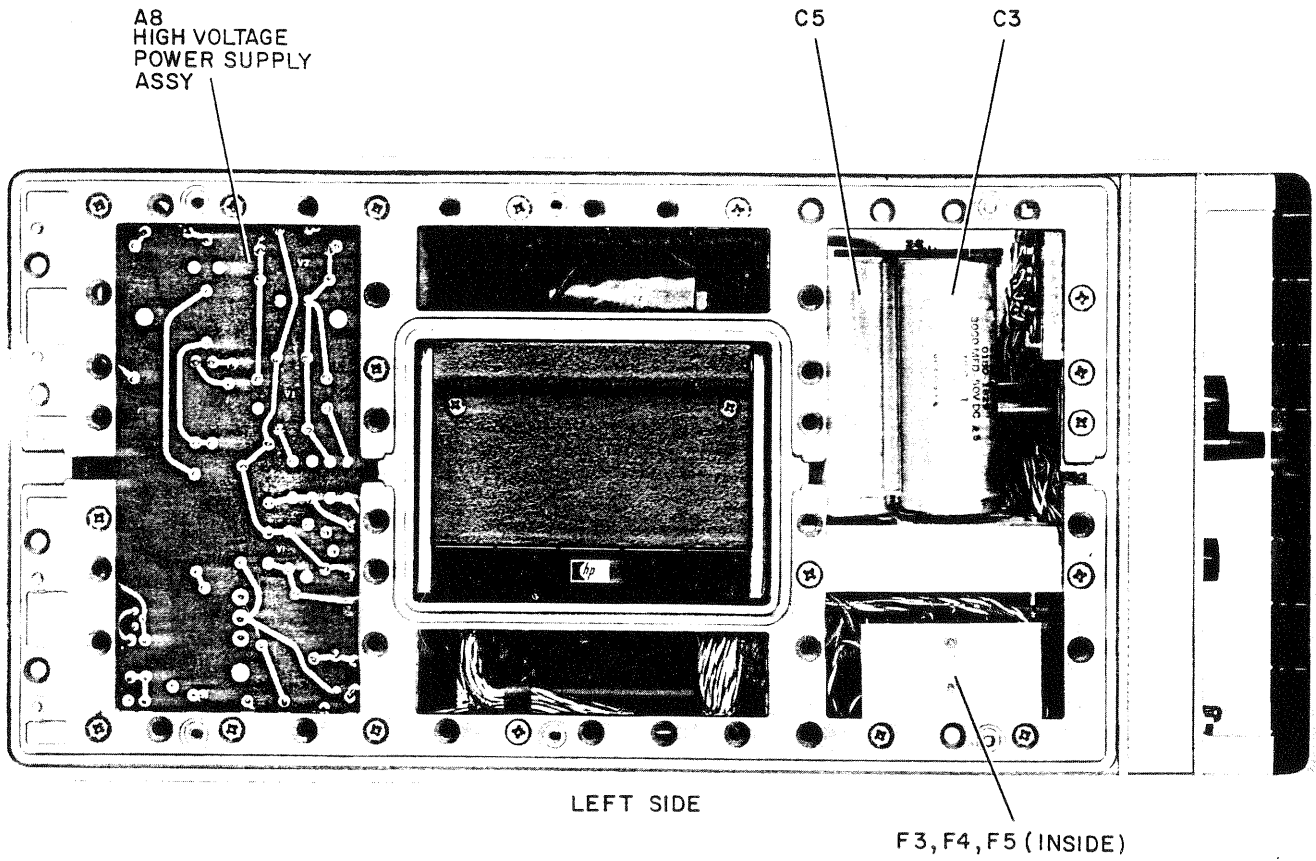

Figure 5-6. Component Identification, Left and Right Side

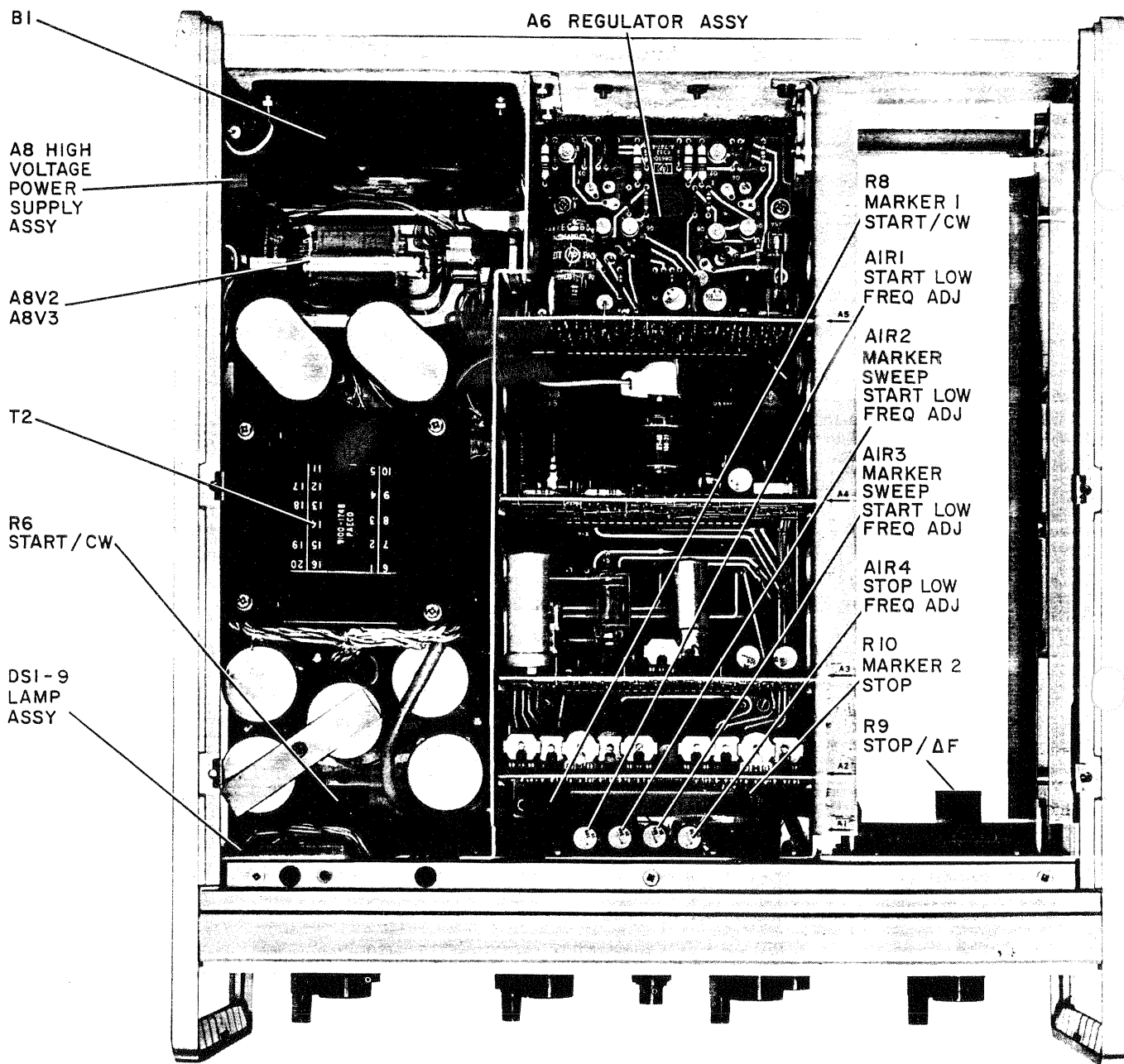

Figure 5-7. Component Identification, Interior Top View

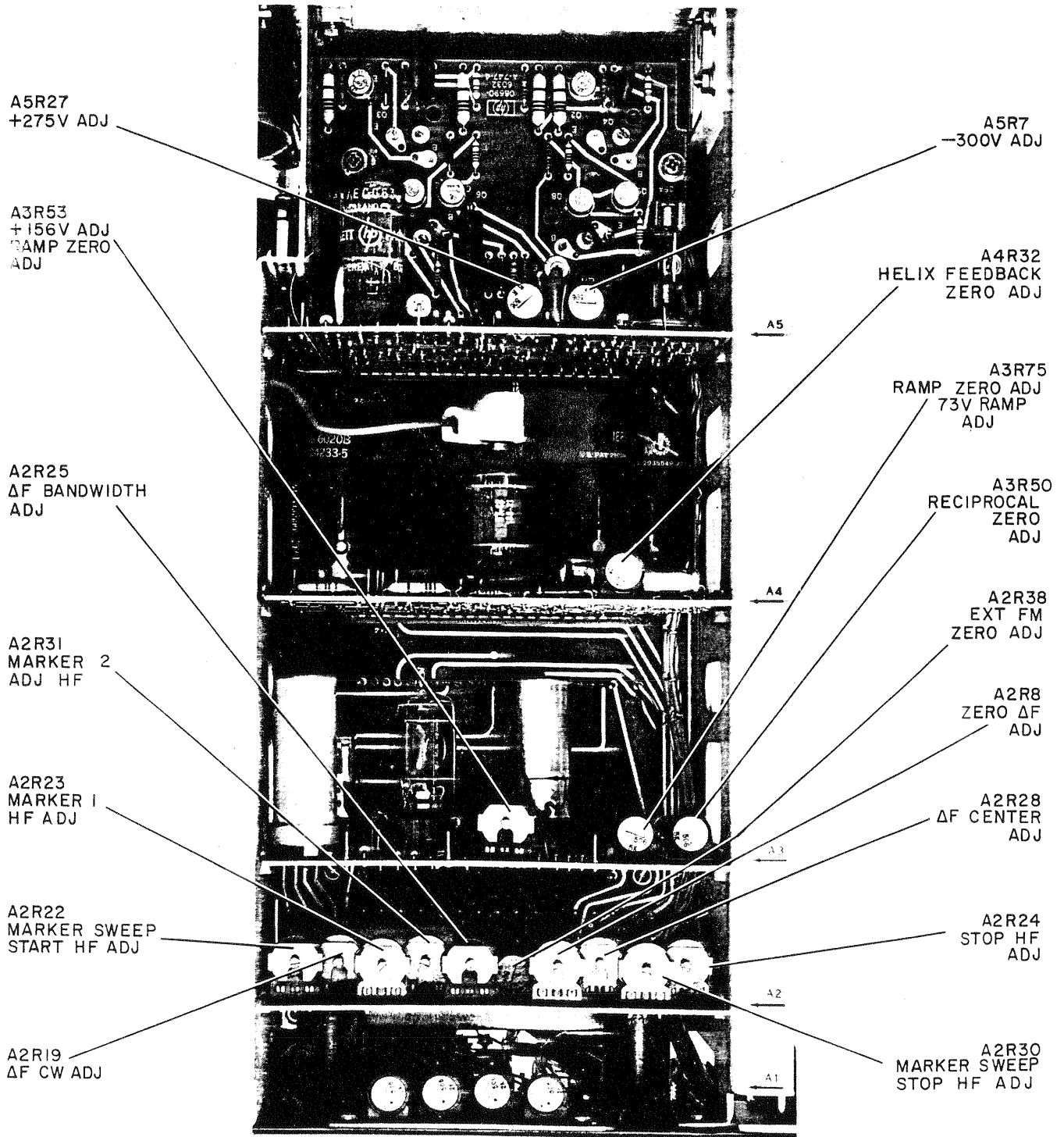

Figure 5-8. Internal Adjustment Identification, Top View

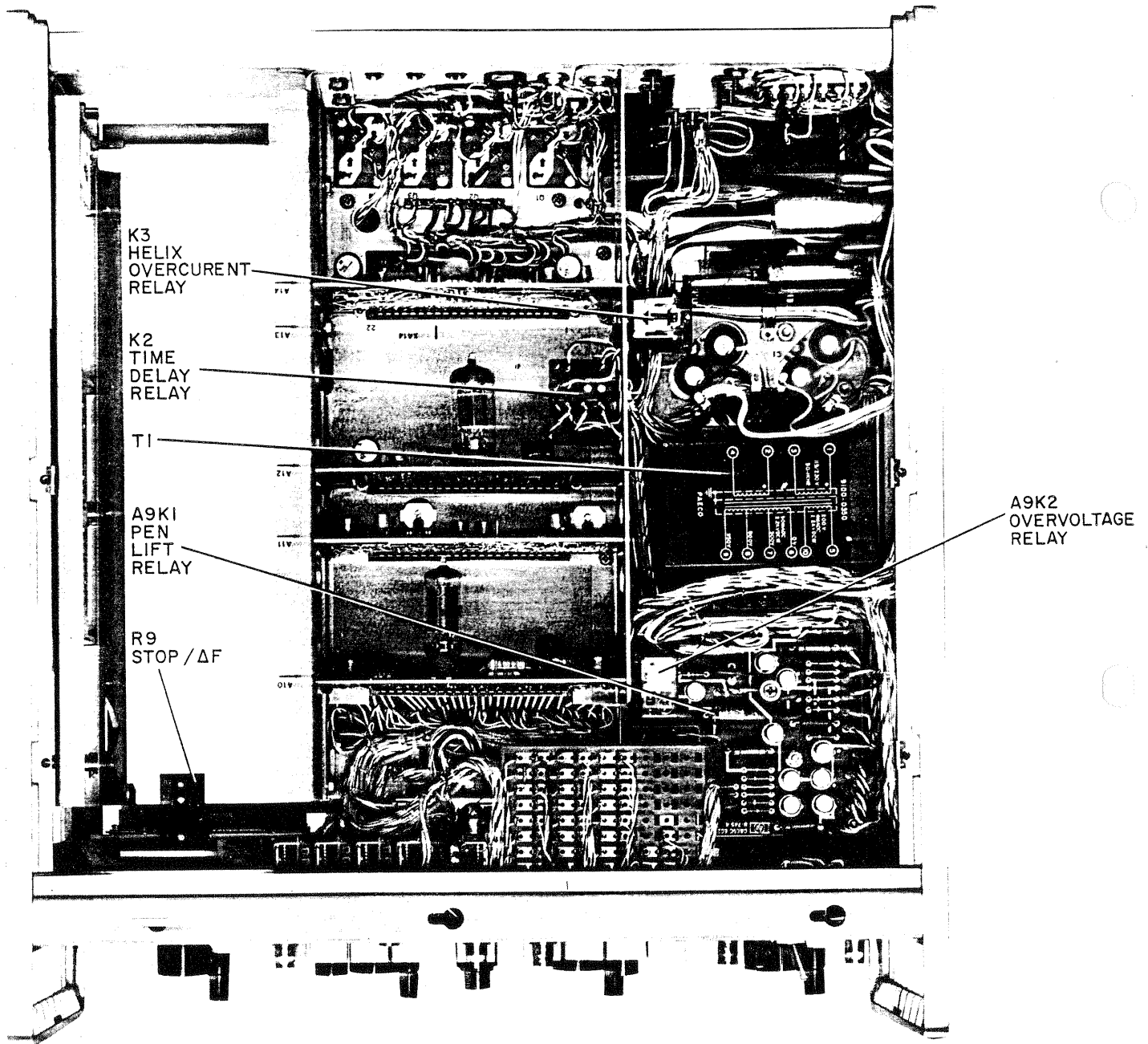

Figure 5-9. Component Identification, Interior Bottom View

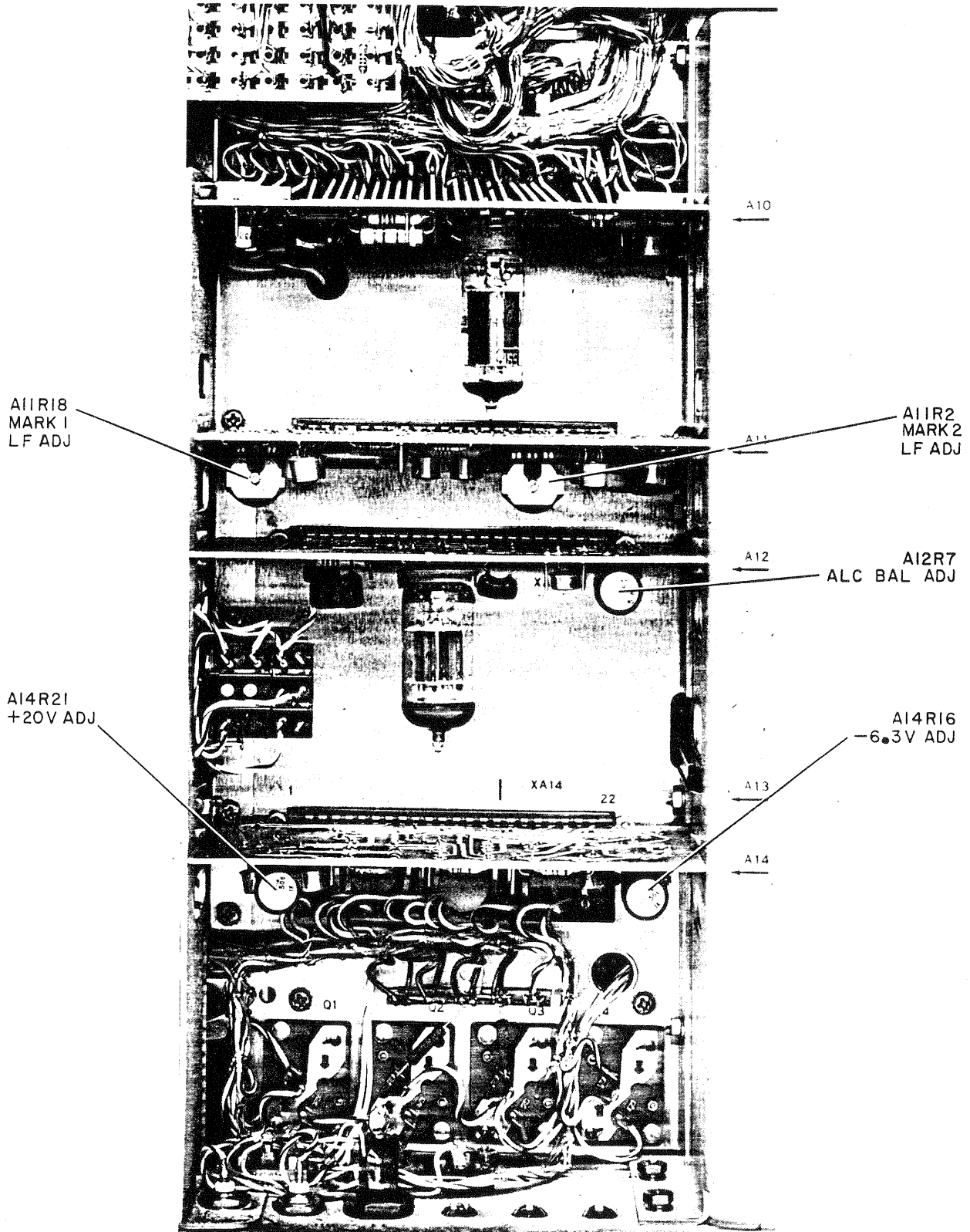

Figure 5-10. Internal Adjustment Identification, Bottom View

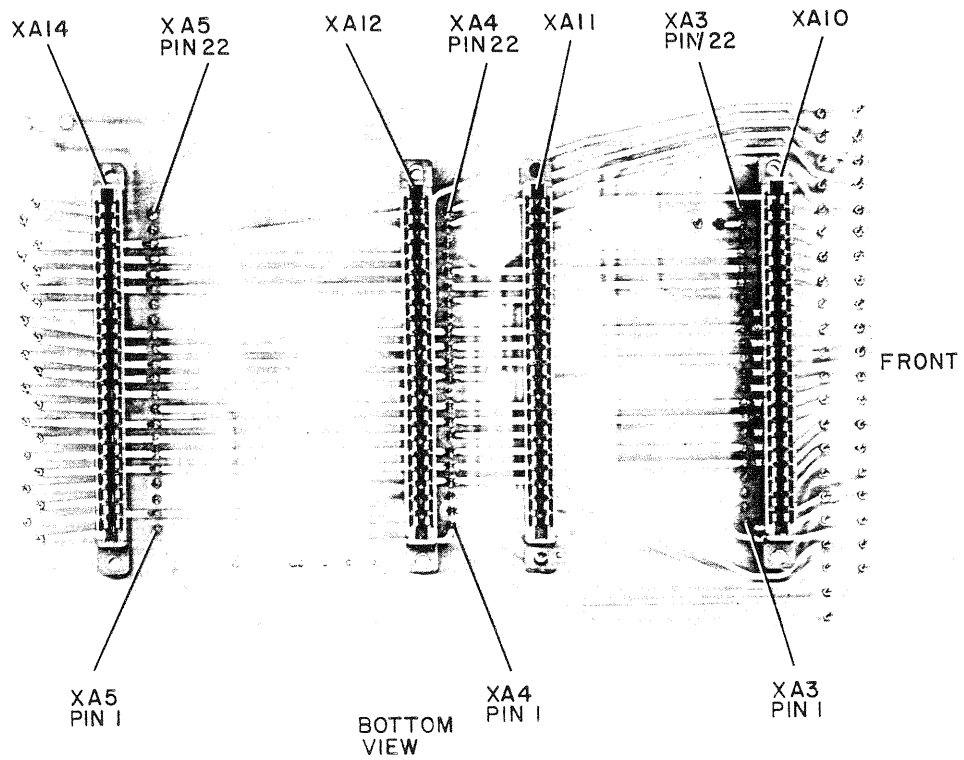
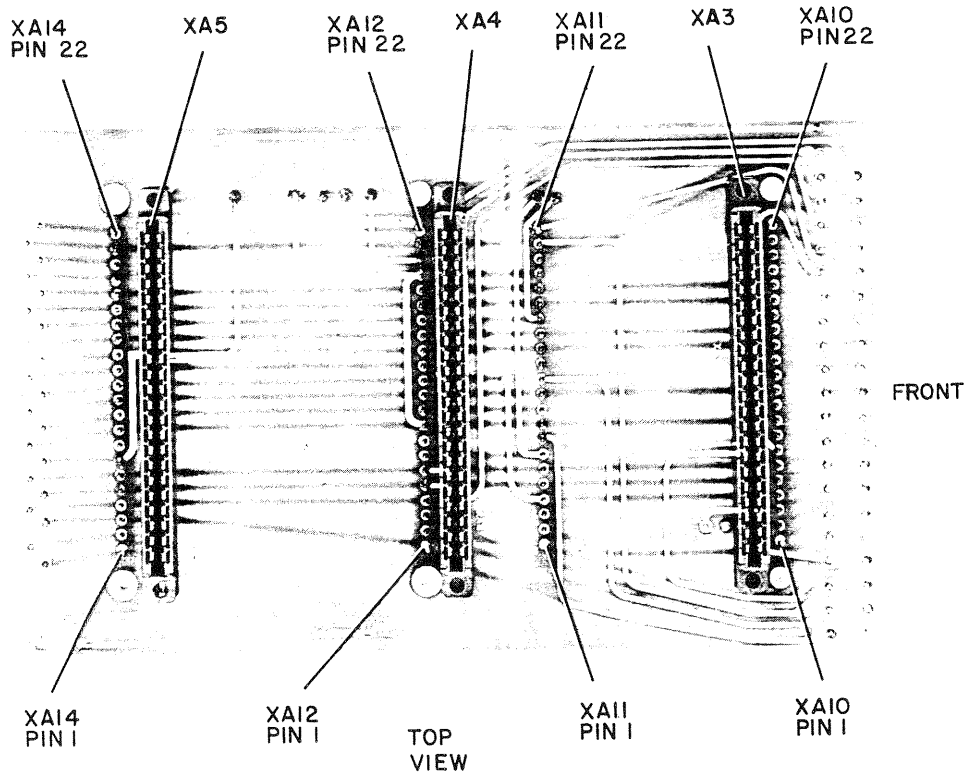

Figure 5-11. Component and Terminal Identification, Interconnection Assembly A7

Table 5-6. Interconnection Assembly A7 Wire Connection Colors

XA3		XA4		XA5		XA10	
Terminal No.	Wire Color	Terminal No.	Wire Color	Terminal No.	Wire Color	Terminal No.	Wire Color
1	914	1	(SH) WHT	1	97	1	957
2	947	2	978	2	0	2	905
3	916	3	925	3	not used	3	958
4	(SH) WHT	4	90	4	not used	4	95
5	1	5	1	5	1	5	3
6	90	6	90	6	90	6	93
7	(SH) BLK	7	934	7	934	7	(SH) WHT
8	7	8	7	8	7	8	938
9	902	9	902	9	902	9	0
10	915	10	913	10	9	10	946
11	914	11	906	11	906	11	92
12	92	12	92	12	92	12	914
13	946	13	923	13	923	13	915
14	0	14	0	14	0	14	902
15	938	15	906	15	not used	15	7
16	948	16	924	16	not used	16	(SH) BLK
17	912	17	912	17	912	17	90
18	901	18	901	18	901	18	1
19	906	19	948	19	2	19	96
20	98	20	945	20	5	20	5
21	968	21	926	21	967	21	94
22	946	22	936	22	925	22	946

NOTE

Refer to Figure 7-1 for explanation of wire color code.

XA11		XA12		XA14	
Terminal No.	Wire Color	Terminal No.	Wire Color	Terminal No.	Wire Color
1	927	1	5	1	915
2	945	2	not used	2	925
3	not used	3	945	3	5
4	906	4	2	4	2
5	901	5	901	5	901
6	912	6	912	6	912
7	924	7	not used	7	902
8	923	8	95	8	not used
9	0	9	0	9	0
10	923	10	923	10	923
11	92	11	92	11	92
12	915	12	906	12	906
13	not used	13	9	13	9
14	902	14	902	14	926
15	7	15	7	15	7
16	934	16	934	16	934
17	90	17	90	17	90
18	1	18	1	18	1
19	90	19	0	19	95
20	937	20	927	20	916
21	968	21	0	21	0
22	967	22	(SH) WHT	22	5

**5-25. ISOLATING TROUBLE
IN TRANSISTOR CIRCUITS.**

5-26. COMPONENT TROUBLE ISOLATION. The following procedures and data are given to aid in determining whether a transistor is operational. Tests are given for both in-circuit and out-of-circuit transistors and should be useful in determining whether a particular section trouble is due to a faulty transistor or an associated component.

5-27. IN-CIRCUIT TESTING. The common causes of transistor failures are internal short- and open-circuits. In transistor circuit testing the most important consideration is the transistor base-emitter junction. Like the control grid of a vacuum tube, this is the operational control point in the transistor. This junction is essentially a solid-state diode. For the transistor to conduct, the diode must conduct; that is, the diode must be forward biased. As with simple diodes, the forward-bias polarity is determined by the materials forming the junctions. Use the transistor symbol on the schematic diagram to determine the bias polarity required to forward-bias the base-emitter junction. The A part of Figure 5-12 shows transistor symbols with terminals labeled. Notice that the emitter arrow points toward the type N material. The other two columns of the illustration compare the biasing required to cause conduction and cut-off in transistors and vacuum tubes. If the transistor base-emitter diode (junction) is forward-biased the transistor conducts. If the diode is heavily forward-biased, the transistor saturates. However, if the base-emitter diode is reverse-biased the transistor is cut off (open). The voltage drop across a forward-biased emitter-base diode varies with transistor collector current. For example, a germanium transistor has a typical forward-bias, base-emitter voltage of 0.2-0.3 volts when collector current is 1-10 mA, and 0.4-0.5 volts when collector current is 10 - 100 mA. In contrast, forward-bias voltage for silicon transistors is about twice that for germanium types; about 0.5-0.6 volts when collector current is low, and about 0.8-0.9 volts when collector current is high.

5-28. Figure 5-12, part B, shows simplified versions of the three basic transistor circuits and gives the operating characteristics of each. When examining a transistor stage, first determine if the emitter-base diode is biased for conduction (forward-biased) by measuring the voltage difference between emitter and base. When using an electronic voltmeter, do not measure directly between emitter and base; there may be sufficient loop current between the voltmeter leads to damage the transistor. Instead, measure each voltage separately with respect to a voltage common point (e.g., chassis). If the emitter-base diode is forward-biased, check for amplifier action by short-circuiting base to emitter while observing collector voltage. The short circuit eliminates base-emitter bias and should cause the transistor to stop conducting (cut off). Collector voltage should then shift to near the supply voltage. Any difference is due to leakage current through the transistor and, in general, the smaller the current, the better the transistor. If collector voltage does not change the transistor has either an

emitter-collector short circuit or emitter-base open circuit.

5-29. OUT-OF-CIRCUIT TESTING. The two common causes of transistor failure are internal short- and open-circuits. Remove the transistor from the circuit and use an ohmmeter to measure internal-resistance. See Table 5-7 for measurement data.

Table 5-7. Out-of-Circuit Transistor Resistance Measurements

Transistor Type		Connect Ohmmeter		Measure Resistance (ohms)
		Pos. lead to	Neg. lead to	
PNP Ger- manium	Small Signal	emitter	base*	200-500
		emitter	collector	10K - 100K
	Power	emitter	base*	30 - 50
		emitter	collector	several hundred
NPN Silicon	Small Signal	base	emitter	1K - 3K
		collector	emitter	very high (might read open)
	Power	base	emitter	200 - 1000
		collector	emitter	high, often greater than 1 M
* To test for transistor action, add collector-base short. Measured resistance should decrease.				

5-30. TUBE, SEMICONDUCTOR REPLACEMENT.

5-31. Table 5-9 lists checks to be made after replacement of certain electron tubes and semiconductors (e.g., diodes, transistors). Replacement of unlisted items does not affect critical Sweep Oscillator functions or operating voltages.

Note

Do not change an operating voltage or calibration adjustment unless it is either definitely outside specified tolerance or calibration accuracy of a dependent function is unsatisfactory. Improving a marginal adjustment can adversely affect calibration.

5-32. ETCHED CIRCUITS.

5-33. The etched circuit boards in the Sweep Oscillator are of the plated-through type consisting of metallic conductors bonded to both sides of insulating material. The metallic conductors are extended through the component mounting holes by a plating process. Soldering can be done from either side of the board with equally good results. Table 5-10 lists recommended tools and materials. Following are recommendations and precautions pertinent to etched circuit repair work.

A. TRANSISTOR BIASING			
DEVICE	SYMBOL	CUT OFF	CONDUCTING
VACUUM TUBE			
N P N TRANSISTOR			
P N P TRANSISTOR			

B. AMPLIFIER CHARACTERISTICS			
CHARACTERISTIC	COMMON BASE	COMMON EMITTER	COMMON COLLECTOR
INPUT Z	30-50 Ω	500-1500 Ω	20-500K Ω
OUTPUT Z	300-500K Ω	30-50K Ω	50-1000 Ω
VOLTAGE GAIN	500-1500	300-1000	< 1
CURRENT GAIN	< 1	25-50	25-50
POWER GAIN	20-30 db	25-40 db	10-20 db

Figure 5-12. Transistor Biasing and Operating Characteristics

CAUTION

Most ohmmeters can supply enough current or voltage to damage a transistor. Before using an ohmmeter to measure transistor forward or reverse resistance, check its open-circuit voltage and short-circuit current output ON THE RANGE TO BE USED. Open -circuit voltage must not exceed 1.5 volts and short-circuit current must be less than 3 mA. See Table 5-8 for safe resistance ranges for some common ohmmeters.

Table 5-8. Safe Ohmmeter Range for Transistor Resistance Measurements

Ohmmeter	Safe Range (s)	Open Ckt Voltage	Short Ckt Current	Lead	
				Color	Polarity
hp 412A hp 427A	R x 1 k R x 10 k R x 100 k R x 1M R x 10M	1.0V 1.0V 1.0V 1.0V 1.0V	1 mA 100 μ A 10 μ A 1 μ A 0.1 μ A	Red Blk	+ -
hp 410C	R x 1 k R x 10 k R x 100 k R x 1M R x 10M	1.3V 1.3V 1.3V 1.3V 1.3V	0.57 mA 57 μ A 5.7 μ A 0.5 μ A 0.05 μ A	Red Blk	+ -
hp 410B	R x 100 R x 1 k R x 10 k R x 100 k R x 1M	1.1V 1.1V 1.1V 1.1V 1.1V	1.1 mA 110 μ A 11 μ A 1.1 μ A 0.11 μ A	Blk Red	+ -
Simpson 260	R x 100	1.5V	1 mA	Red Blk	+ -
Simpson 269	R x 1 k	1.5V	0.82 mA	Blk Red	+ -
Triplet 630	R x 100 R x 1 k	1.5V 1.5V	3.25 mA 325 μ A	Varies with Serial Number	
Triplet 310	R x 10 R x 100	1.5V 1.5V	750 μ A 75 μ A		

Table 5-9. Checks Following Tube, Semiconductor Replacement

Reference Designation	Check	Reference Designation	Check
A3CR3 A3CR4	Adjustments 3, 4, 5 (Table 5-4)	A5V1	-83V supply voltage +275V supply voltage, ripple, regulation
A3CR5 A3CR6	Adjustment 4 (Table 5-4)	A5V2	-83V supply voltage
A3V1	+156V supply, BWO anode voltage	A6Q1, A6Q2 A5Q1-Q4	+275V supply voltage, ripple, regulation
A3V2	+156V supply	A6Q3, A6Q4 A5Q5-Q8	-83V supply voltage
A3V3	+156V supply, +81V supply	A8Q1	Turn-on time delay
A3V4	Adjustment 3, 4, 5 (Table 5-4)	A11CR16 A11Q1-Q8	Performance Tests 8, 9, 11, 16, 17, 18 (Table 5-2)
A3V5 A3V6	Adjustment 4 (Table 5-4)	A12Q1-Q4 A12V1	Performance Tests 2, 3, 4 (Table 5-2)
A4CR8	Performance Tests 5, 6, 7 (Table 5-2)	A14CR1	12.6V supply ripple, regulation
A4Q1 A4Q2 A4V1	Adjustments 3, 4, 5 (Table 5-4)	A14CR2	12.6V supply output voltage
A4V2	Performance Tests 5, 6, 7 (Table 5-2)	A14Q1, A14Q2	12.6V supply
A4V3 A4V4	Performance Tests 8, 9, 11 (Table 5-2)	Q1 A14Q3-Q6	+20V supply
A4V5 A4V6	Performance Tests 5, 6, 7 (Table 5-2)	Q2, Q3 A14Q7, A14Q8	-6.3V supply

a. Avoid unnecessary component substitution: it can result in damage to the circuit board and/or adjacent components.

b. Do not use a high-power soldering iron on etched circuit boards. Excessive heat may lift a conductor or damage the board.

c. Use a suction device (Table 5-10) or wooden toothpick to remove solder from component mounting holes. DO NOT USE A SHARP METAL OBJECT SUCH AS AN AWL OR TWIST DRILL FOR THIS PURPOSE. SHARP OBJECTS MAY DAMAGE THE PLATED-THROUGH CONDUCTOR.

d. After soldering, remove excess flux from the soldered areas and apply a protective coating to prevent contamination and corrosion. See Table 5-10 for recommendations.

e. When removing a multiple-connection component held tightly in a socket, such as a vacuum tube, loosen it gradually using gentle side-to-side or rotary motion to avoid damage to the plated-through conductors.

5-34. COMPONENT REPLACEMENT.

a. Remove defective component from circuit board.

b. Remove solder from mounting holes using a suction desoldering aid (Table 5-10) or wooden toothpick.

c. Shape leads of replacement component to match mounting hole spacing.

d. Insert component leads into mounting holes, and position component as original was positioned. DO NOT FORCE LEADS OF REPLACEMENT COMPONENT INTO MOUNTING HOLES. Sharp lead ends may damage plated-through conductor.

Table 5-10. Etched Circuit Soldering Equipment

Item	Use	Specification	Item Recommended
Soldering Tool	Soldering Unsoldering	Wattage rating: 37.5 Tip Temp: 750 - 800°F Tip Size: 1/8" OD	Ungar #776 Hangel with Ungar #1237 Heating Unit
Soldering Tip, general purpose	Soldering Unsoldering	Shape: chisel Size: 1/8"	Ungar #PL113
De-soldering aid	Unsoldering multi- connection components (e.g., tube sockets)	Suction device to remove molten solder from connection	Soldapullt by the Edsyn Company, Arleta, California
Resin (flux) solvent	Remove excess flux from soldered area before application of protective coating	Must not dissolve etched circuit base board material or conductor bonding agent	Freon Acetone Lacquer Thinner Isopropyl Alcohol (100% dry)
Solder	Component replacement Circuit board repair Wiring	Resin (flux) core, high tin content (60/40 tin/lead), 18 gauge (SWG) preferred	
Protective Coating	Contamination, corrosion protection after soldering	Good electrical insulation, corrosion-prevention properties	Krylon #1302* Humiseal Protective Coating, Type 1B12 by Columbia Technical Corp. Woodside 77, New York
* Krylon, Inc., Norristown, Pennsylvania			

Note

Axial lead components, such as resistors and tubular capacitors, can be replaced without unsoldering. Clip leads near body of defective component, remove component and straighten leads left in board. Wrap leads of replacement component one turn around original leads. Solder wrapped connection, and clip off excess lead.

5-35. TUBE SOCKET REPLACEMENT. There are three ways to remove a tube socket from the etched circuit board:

- a. Cut terminals attaching socket to circuit board, remove socket, and unsolder remaining terminal pieces individually.
- b. Using long nose pliers, break insulating material of socket away from metal connectors, then unsolder connectors from board individually.
- c. Use a special soldering iron tip designed to heat all socket connections simultaneously and remove socket as a unit; or use a suction device (Table 5-10) to desolder all connections and remove socket.

5-36. TRANSISTOR REPLACEMENT.

- a. Do not apply excessive heat. See Table 5-10 for soldering tool specifications.
- b. Use a heat sink such as pliers between transistor body and hot soldering iron.
- c. When installing a replacement transistor, ensure sufficient lead length to dissipate heat of soldering by maintaining about the same length of exposed lead as used for original transistor.

5-38. Transistor Q1, Q2, Q3, Q4, Q5 (series regulators, power supplies) and BWO heater over-voltage protection diode CR2 are high current types which require good thermal contact with mounting surfaces for adequate heat dissipation. To assure good thermal contact for a replacement transistor, coat both sides of the black insulator with Dow Corning #5 silicone compound or equivalent before fastening the transistor to the chassis. When replacing diode CR2, coat the diode case outside surface before adding the heat dissipater, and coat both sides of both black insulator before bolting the dissipater assembly to the sub-chassis. Dow Corning #5 compound is available in 8-oz. tubes from Hewlett - Packard; order hp Stock Number 8500-0059.

5-39. A12Q1 LEAD IDENTIFICATION.

5-40. ALC Amplifier transistor A12Q1 is a dual transistor (i.e., two transistors in one case). For this configuration, the locating tab which protrudes from the rim of the transistor case identifies the collectors, not the emitters.

5-41. TROUBLESHOOTING.

5-42. Check the fuses to ensure that one or more are not open. Make a thorough visual inspection for burned out or loose components, loose connections, contaminated switch contacts or any condition that may suggest a source of trouble.

5-43. TROUBLE ISOLATION. Figures 5-13, 5-14, and 5-15 suggest a logical approach to troubleshooting the 8690B. They are meant to give an understanding of the instrument, and to isolate a problem down to a specific area. From there, normal troubleshooting procedures should be used to isolate the faulty component. Circuits in the 8690B RF Unit combinations are divided according to the predominant effect of each on the basic circuit functions in the instrument. The nine basic functions are: 1) power output, 2) sweep, 3) calibration, 4) linearity, 5) amplitude, 6) frequency modulation, 7) blanking, 8) markers, and 9) power supply. These nine functions provide the basis for the troubleshooting analysis given in Figures 5-14 and 5-15.

5-44. Figures 5-14 and 5-15 are troubleshooting flow diagrams. Figure 5-13 shows the symbols used and the constant meaning of each symbol. Generally, the flow is from top to bottom and left to right. Entry transfers from another part of the flow diagram always

enter from the left and exit transfers leave to the right. Whenever possible, a given path or subject is shown complete on one page. If branching occurs, transfer points are keyed with corresponding letters or numbers.

5-45. Figure 5-14 provides an index for all troubleshooting flow diagrams. The indexing sequence is divided into the eight basic circuit functions. The Troubleshooting Flow Index can be used in two ways. To make a quick determination of the general area and degree (minor or major) of the circuit malfunction, the index can be entered at any defined entry point. Choose the entry point that corresponds with the "Function To Be Performed" symbol that best describes the particular problem encountered. The basic circuit functions are given at the bottom of each Troubleshooting Flow Index page to assist in locating the proper entry point.

5-46. The Troubleshooting Flow Index can also be used to completely determine the circuit malfunction. A decision of which entry point in the index to choose is not required. To use the index in this way, start at the beginning of the first flow sequence and continue through the index until branching to the Detailed Troubleshooting Flow, Figure 5-15, occurs. It is important that the procedures listed in Figure 5-14 be performed in the order listed. Each step provides the basis on which the indications of a subsequent step are analyzed.

5-47. The Detailed Troubleshooting Flow diagram, Figure 5-15, provides a continuation of the troubleshooting analysis started in the Troubleshooting Flow Index, Figure 5-14. As in Figure 5-14, perform the detailed troubleshooting procedures in the order specified. Subsequent decisions assume that certain previous indications and results have been obtained. The procedures in Figure 5-15 are intended only to suggest the most probable functional circuit failure and to give a general direction in which to look before starting a component-by-component troubleshooting procedure. The flow diagrams are based on the assumption that only one basic function circuit has failed.

5-48. DETAILED TROUBLESHOOTING. To assist detailed troubleshooting, normal operation waveforms are given in Section VII. Specific conditions of waveform measurement are stated adjacent to the appropriate waveform. DC voltage levels are shown for each element of every active component (e.g., transistor). Waveform and voltage measurement conditions are noted on each schematic. Instrument settings other than those noted are as stated in Paragraph 5-21, Adjustment Control Settings.

5-49. The power supplies provide dc operating voltages for all circuits in the Sweep Oscillator - RF Unit combinations. Thus, a fault in the power supply sections can result in a false trouble indication within any of the dependent basic functional circuits. However, never adjust a power supply voltage if the dc output is only slightly out of tolerance. Adjustment of a slightly out of tolerance supply voltage can degrade the performance of one or more instrument functions.

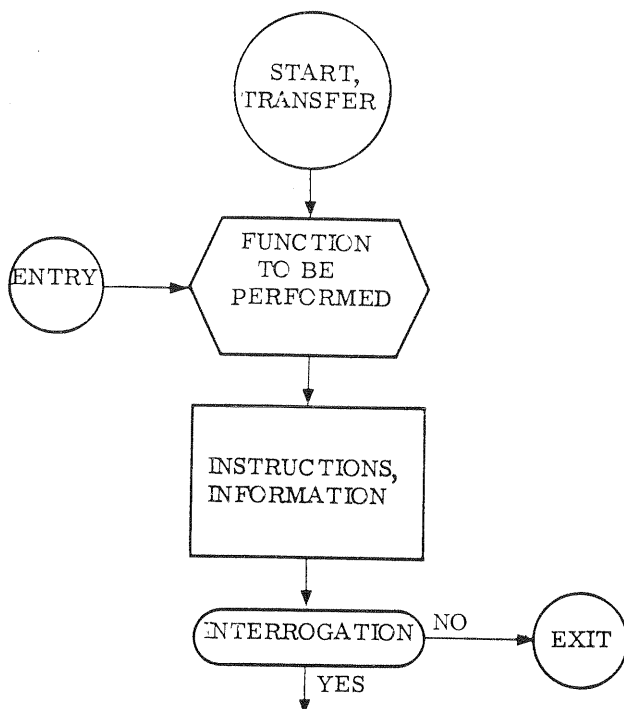

Figure 5-13. Flow Diagram Symbols and Definitions

5-50. Normal variation in component operating characteristics account for variation in normal operating voltages when various RF Unit - Sweep Oscillator combinations are used. For example, a $\pm 10\%$ variation in the voltages shown at the collector of A14Q5 (+20 volt supply) would be normal while variation in dc voltages within the regulators of the +20 volt supply would be ± 0.2 volt. Normal variation for the regulators in the 6.3 volt supply would be

± 0.1 volt and $\pm 5\%$ for the regulators of the 12.6 volt supply.

5-51. Measurements within the transistorized power supplies should be made with reference to 8690A chassis ground. This will avoid damage to transistors caused by loop currents which may result if the measuring instrument reference potential is not at ground potential.

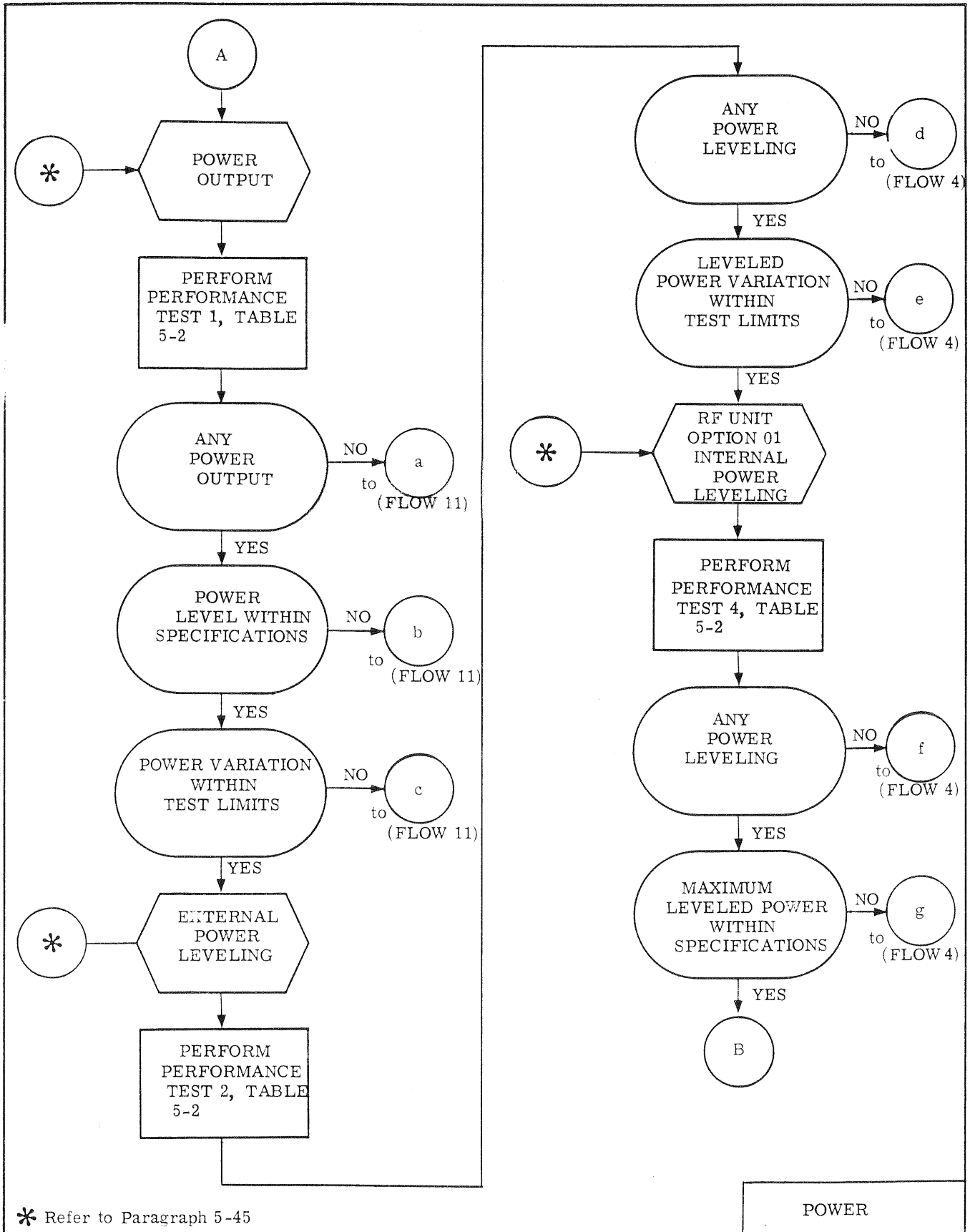

Figure 5-14. Troubleshooting Flow Index

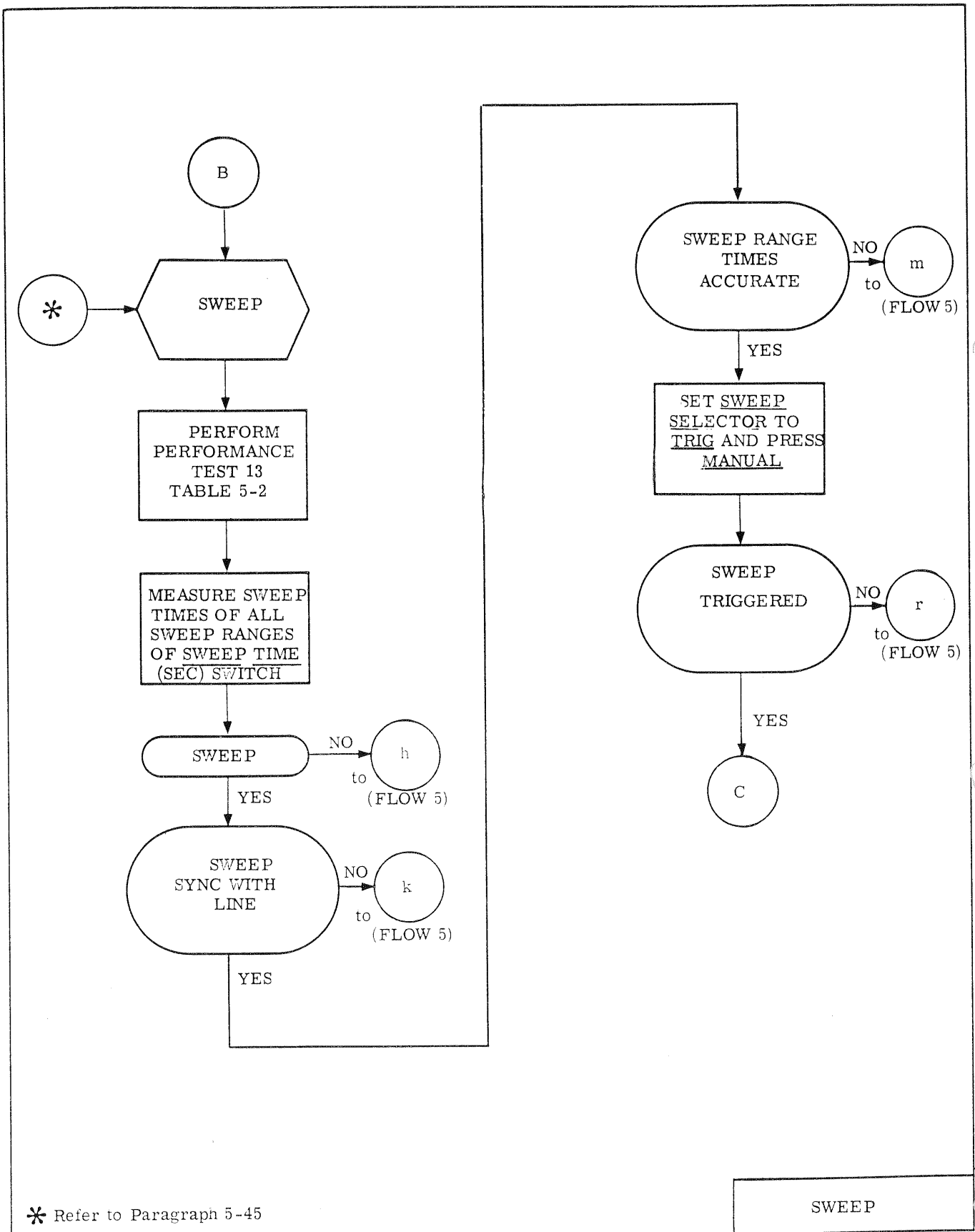

Figure 5-14. Troubleshooting Flow Index (Continued)

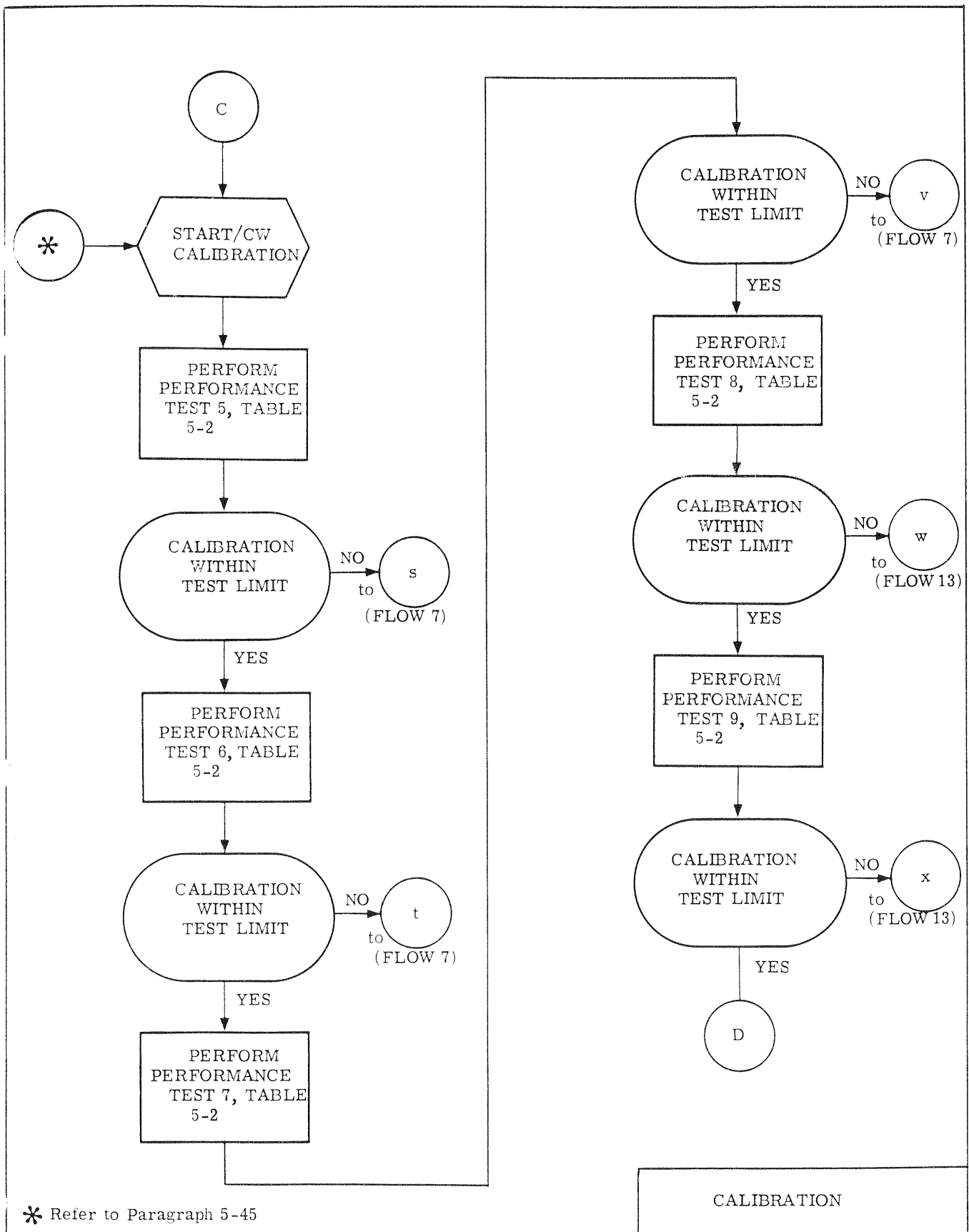

Figure 5-14. Troubleshooting Flow Index (Continued)

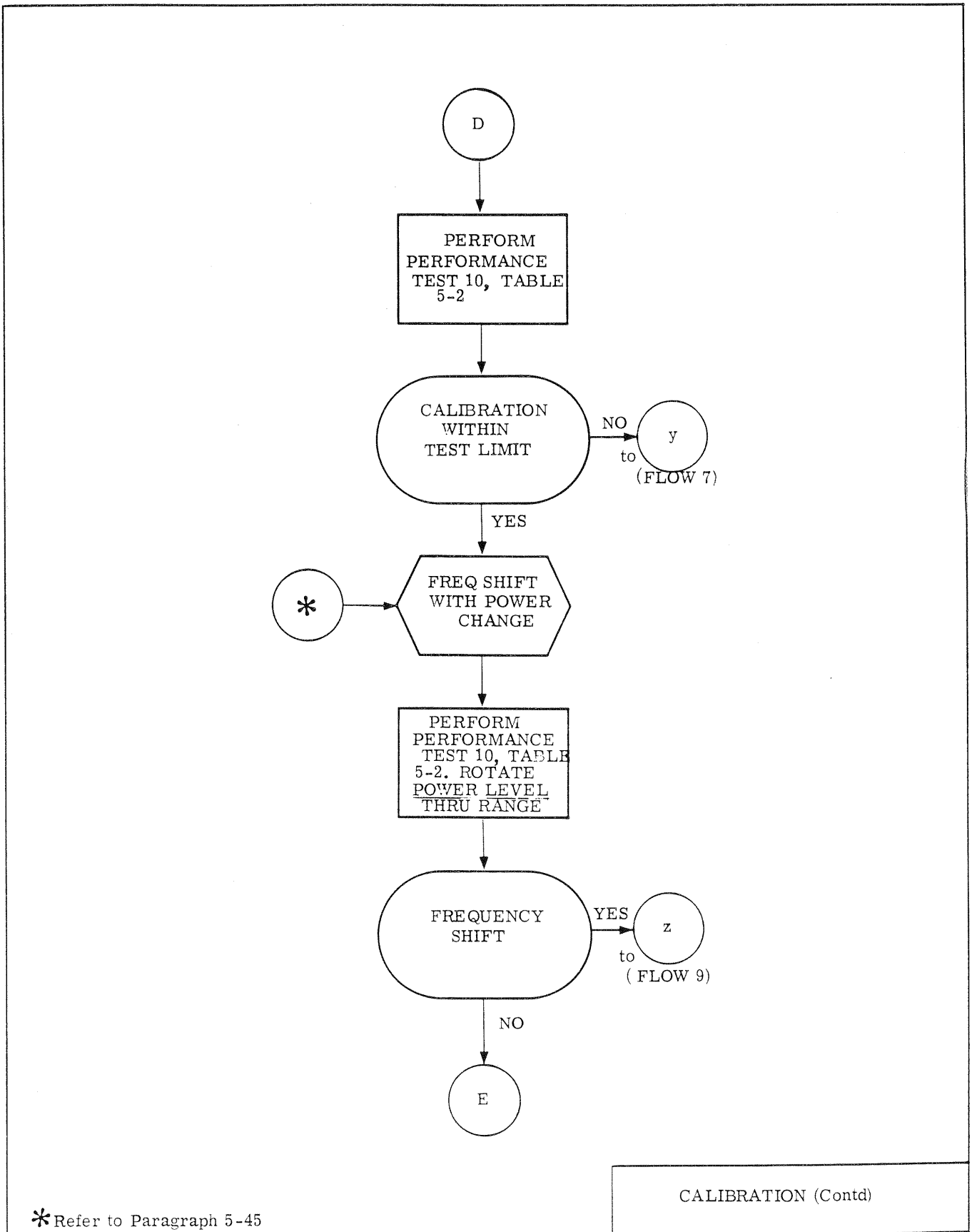

Figure 5-14. Troubleshooting Flow Index (Continued)

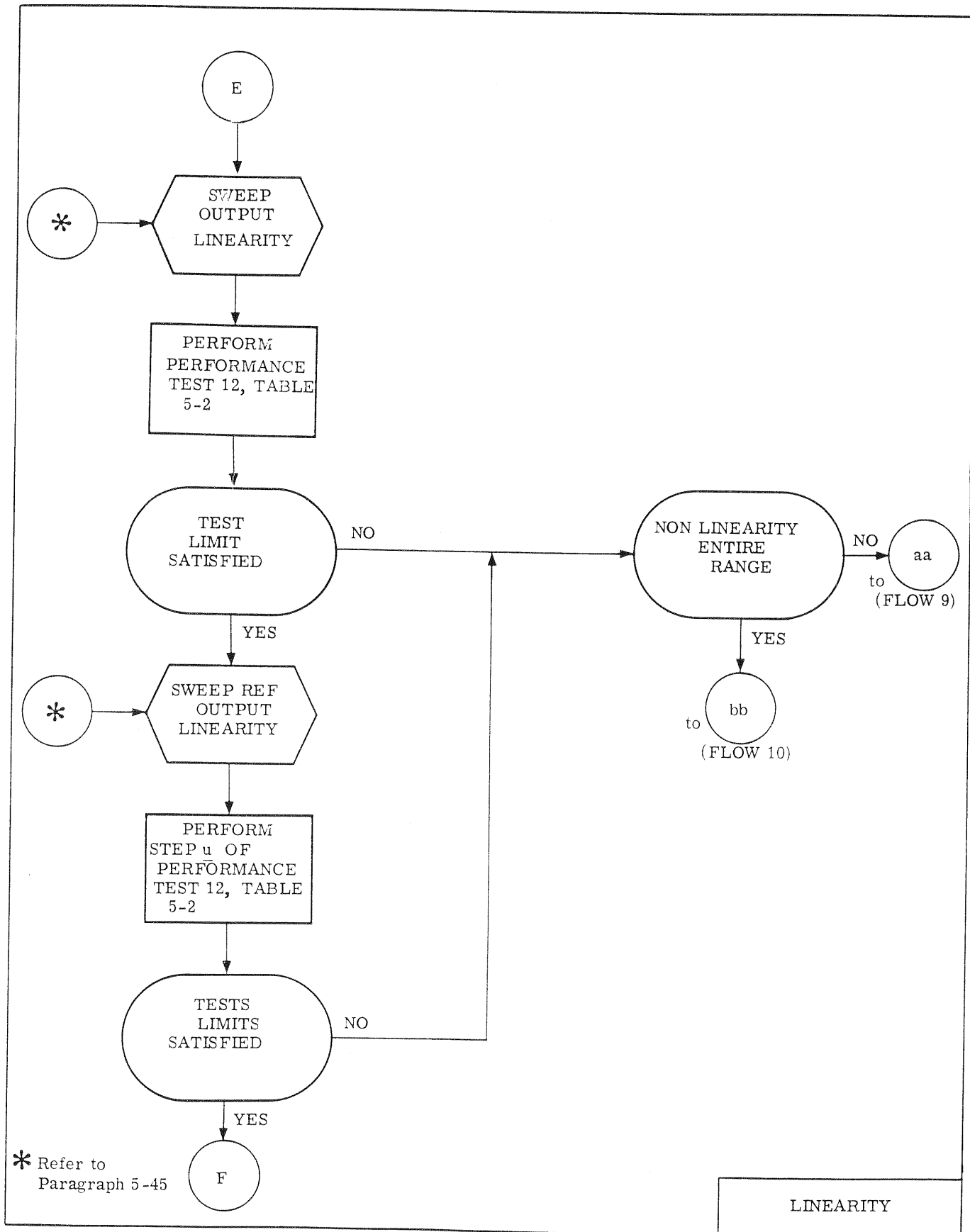

Figure 5-14. Troubleshooting Flow Index (Continued)

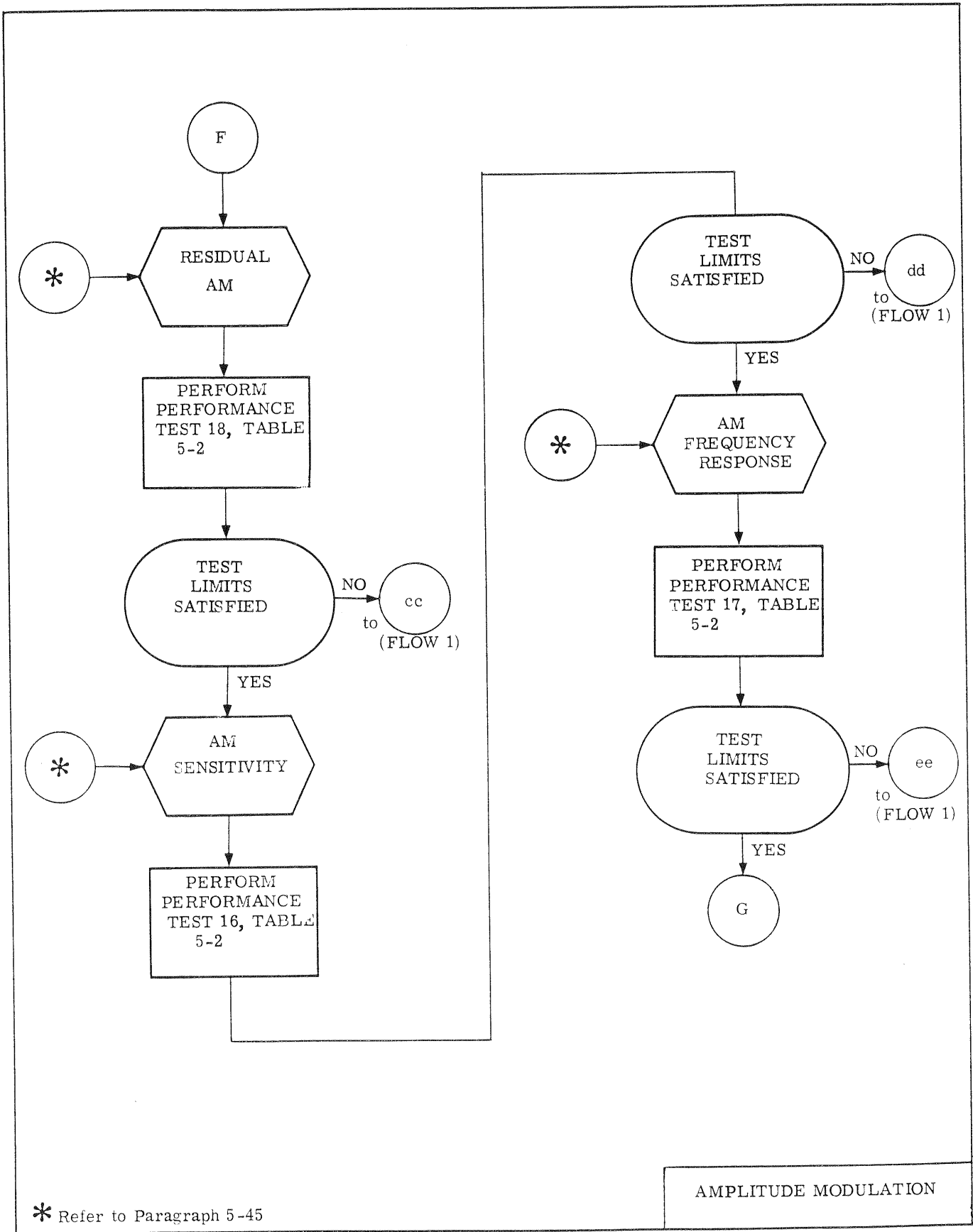

Figure 5-14. Troubleshooting Flow Index (Continued)

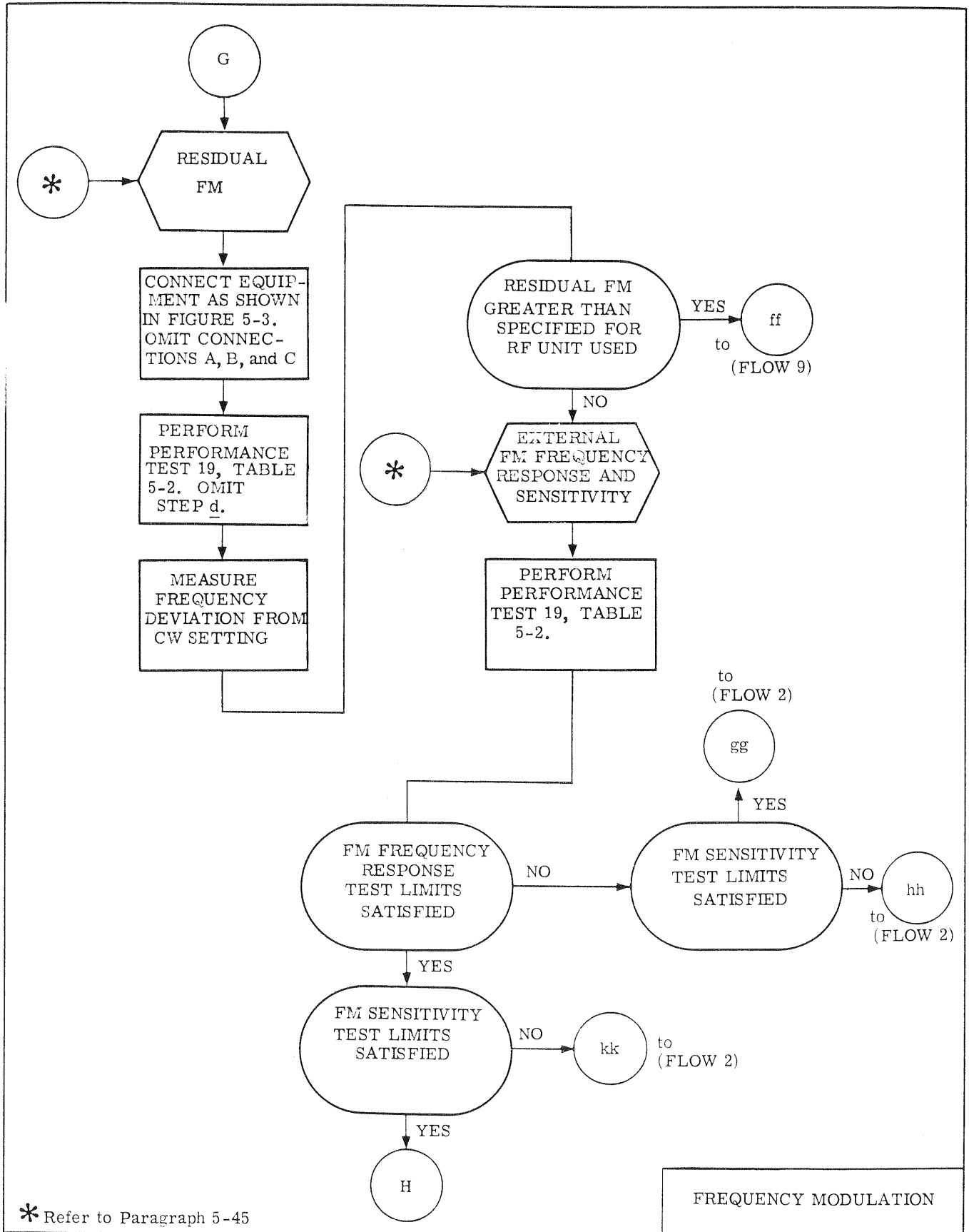

Figure 5-14. Troubleshooting Flow Index (Continued)

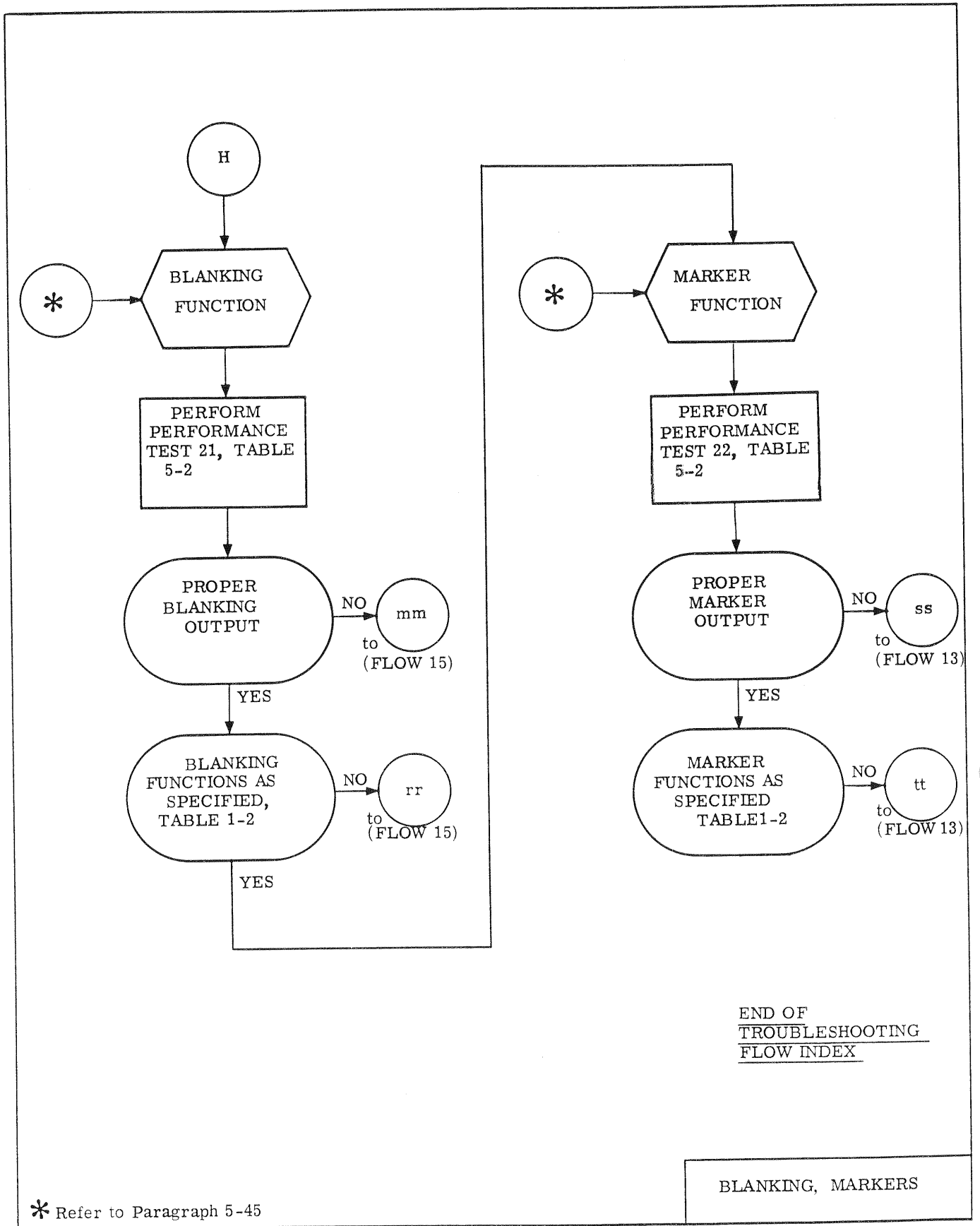
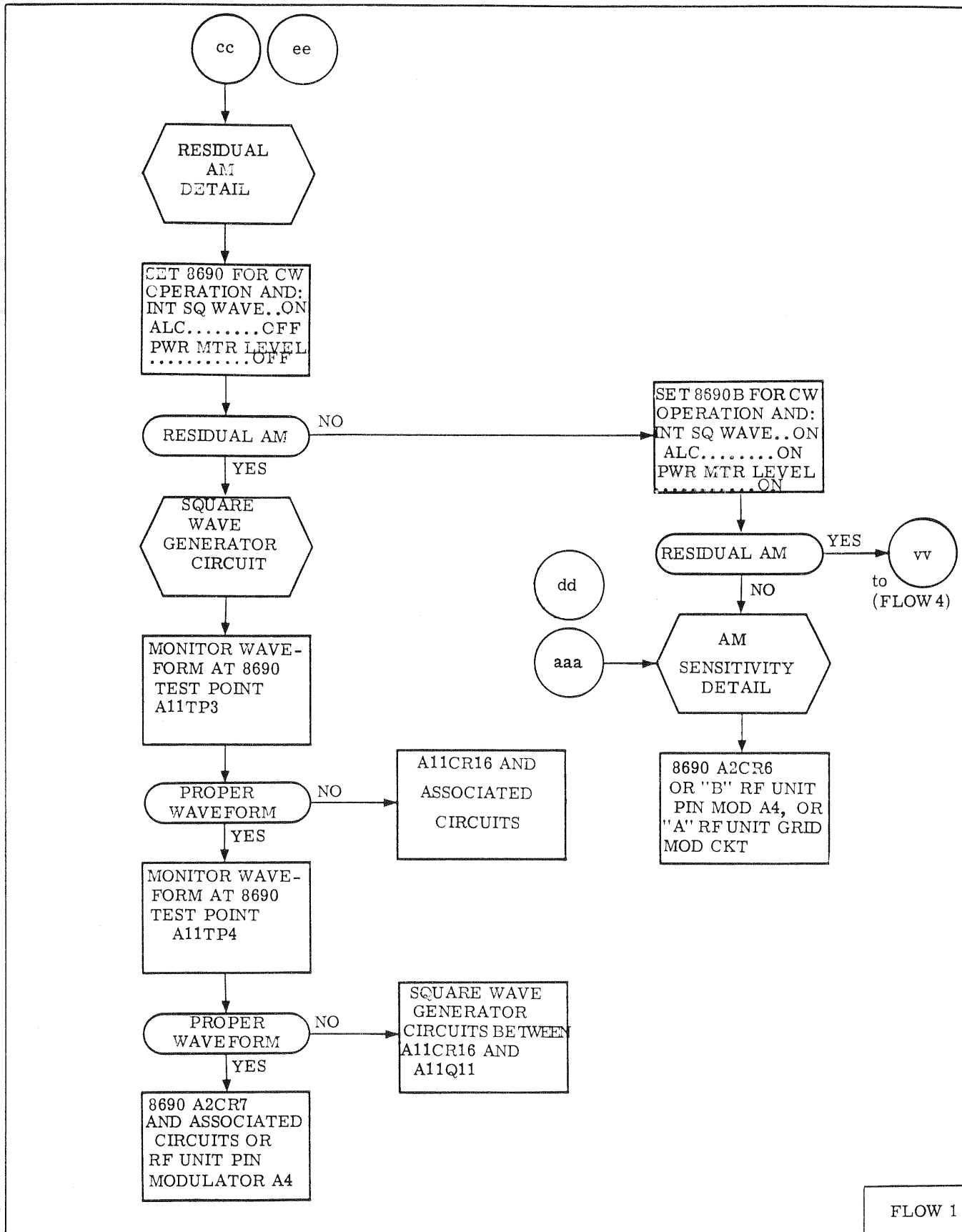

Figure 5-14. Troubleshooting Flow Index (Continued)



FLOW 1

Figure 5-15. Detailed Troubleshooting Flow

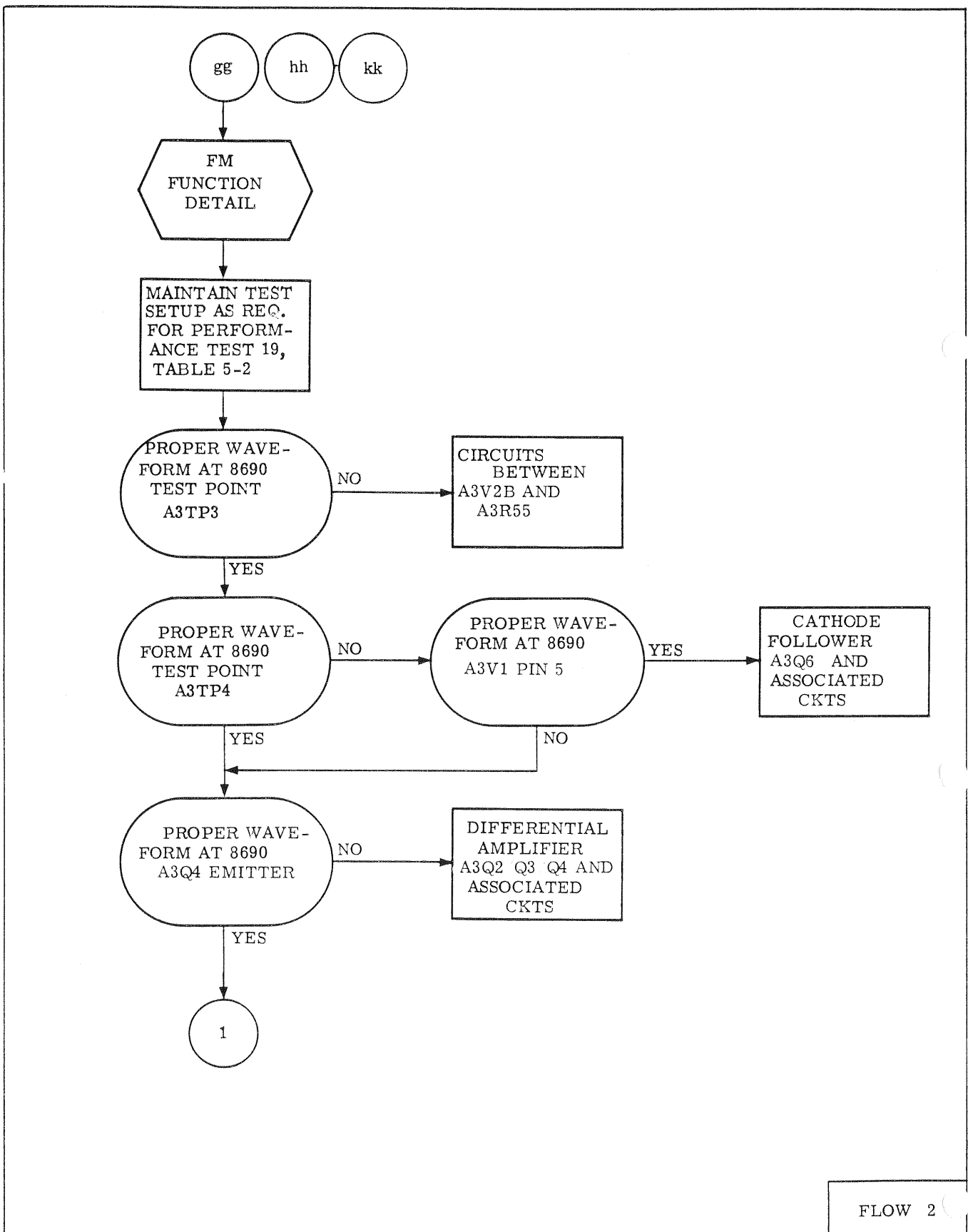

Figure 5-15. Detailed Troubleshooting Flow (Continued)

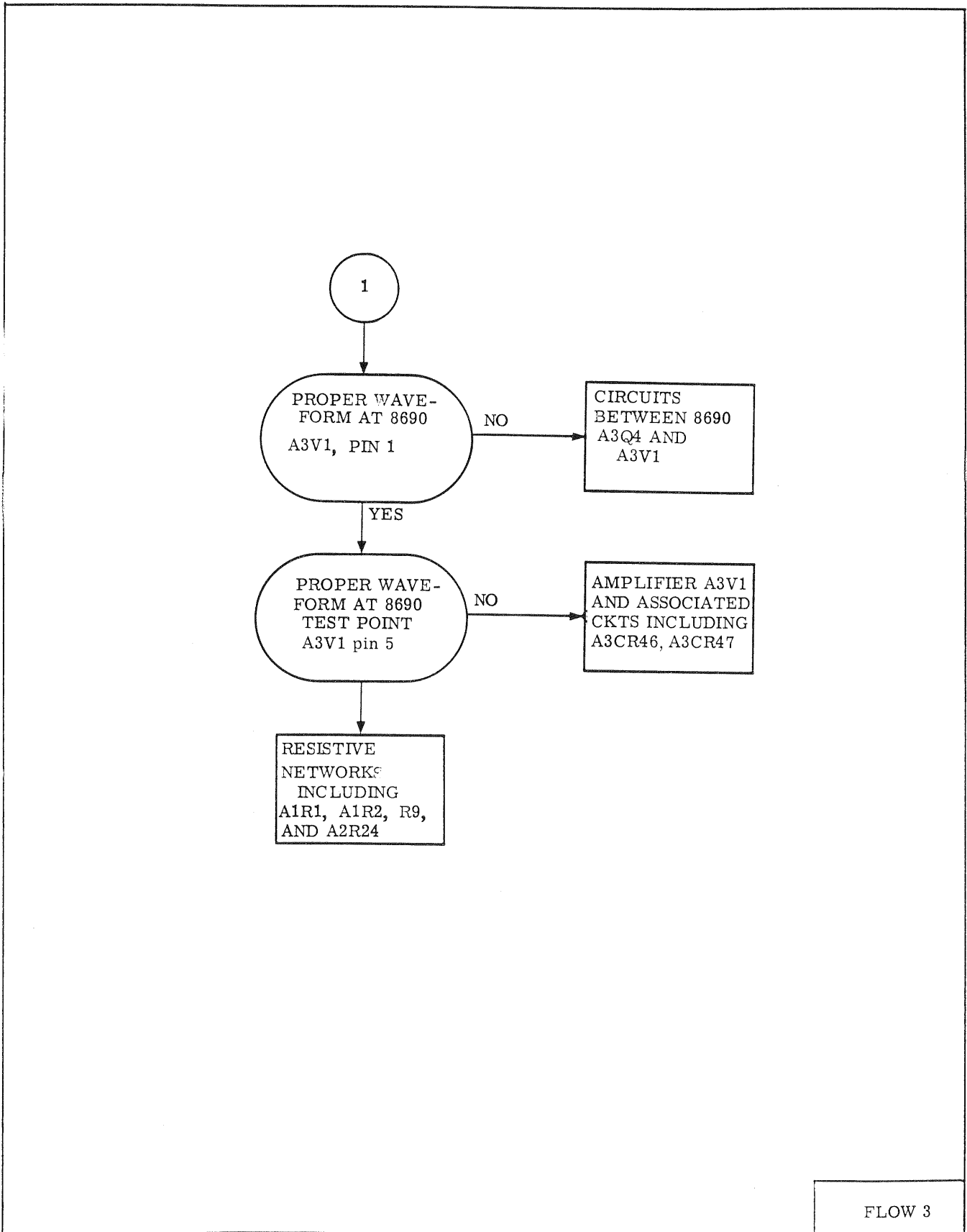

Figure 5-15. Detailed Troubleshooting Flow (Continued)

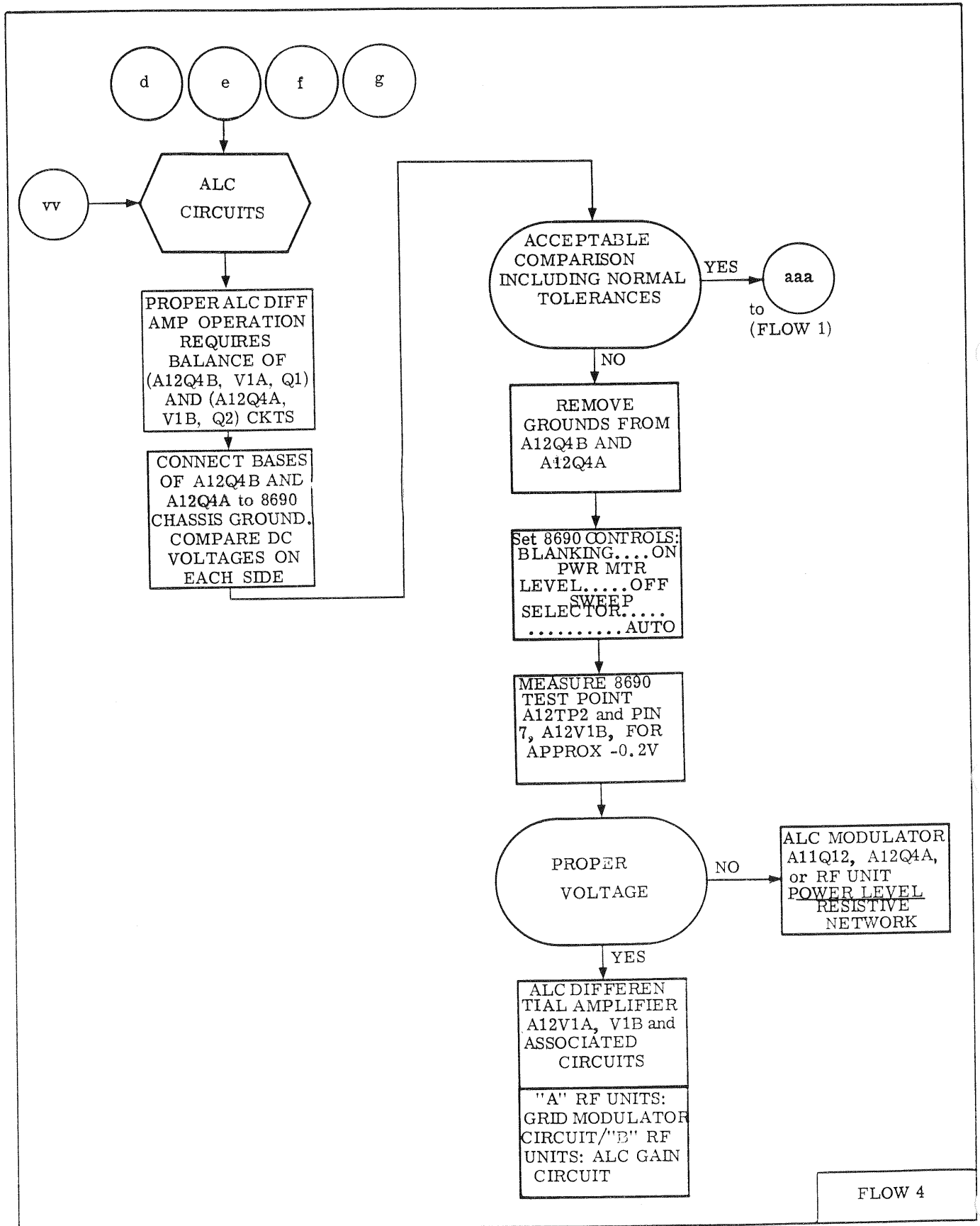

Figure 5-15. Detailed Troubleshooting Flow (Continued)

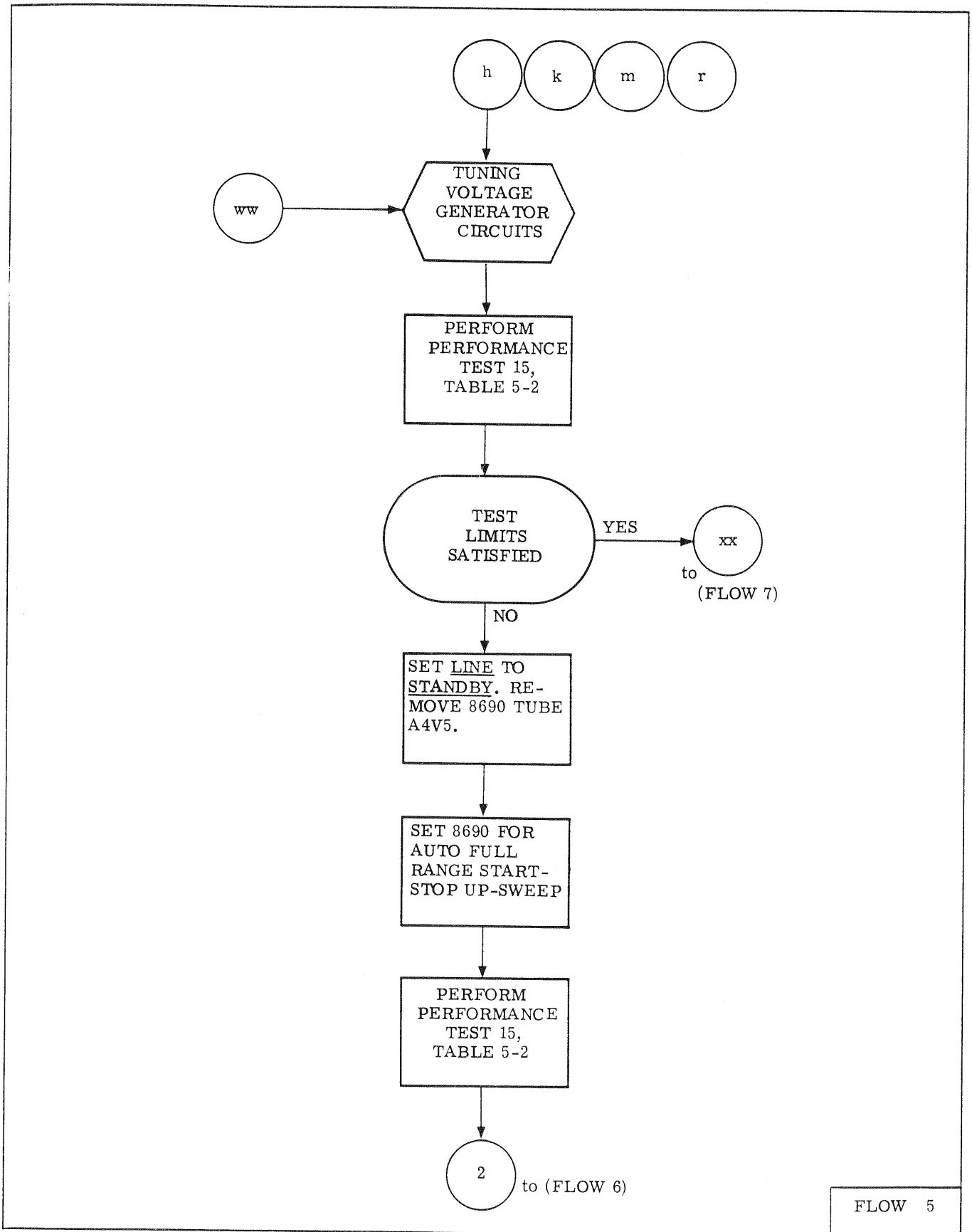
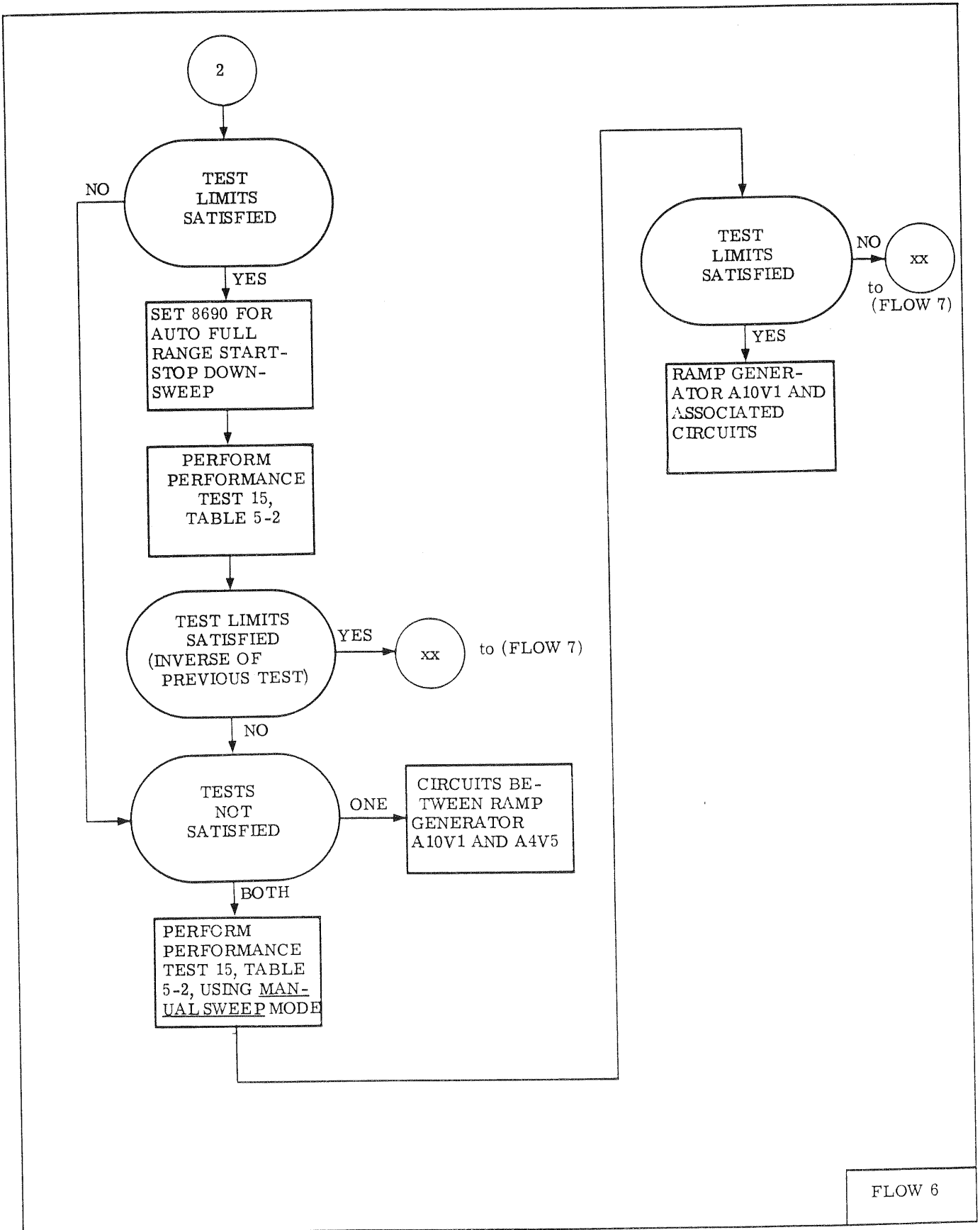

Figure 5-15. Detailed Troubleshooting Flow (Continued)



FLOW 6

Figure 5-15. Detailed Troubleshooting Flow (Continued)

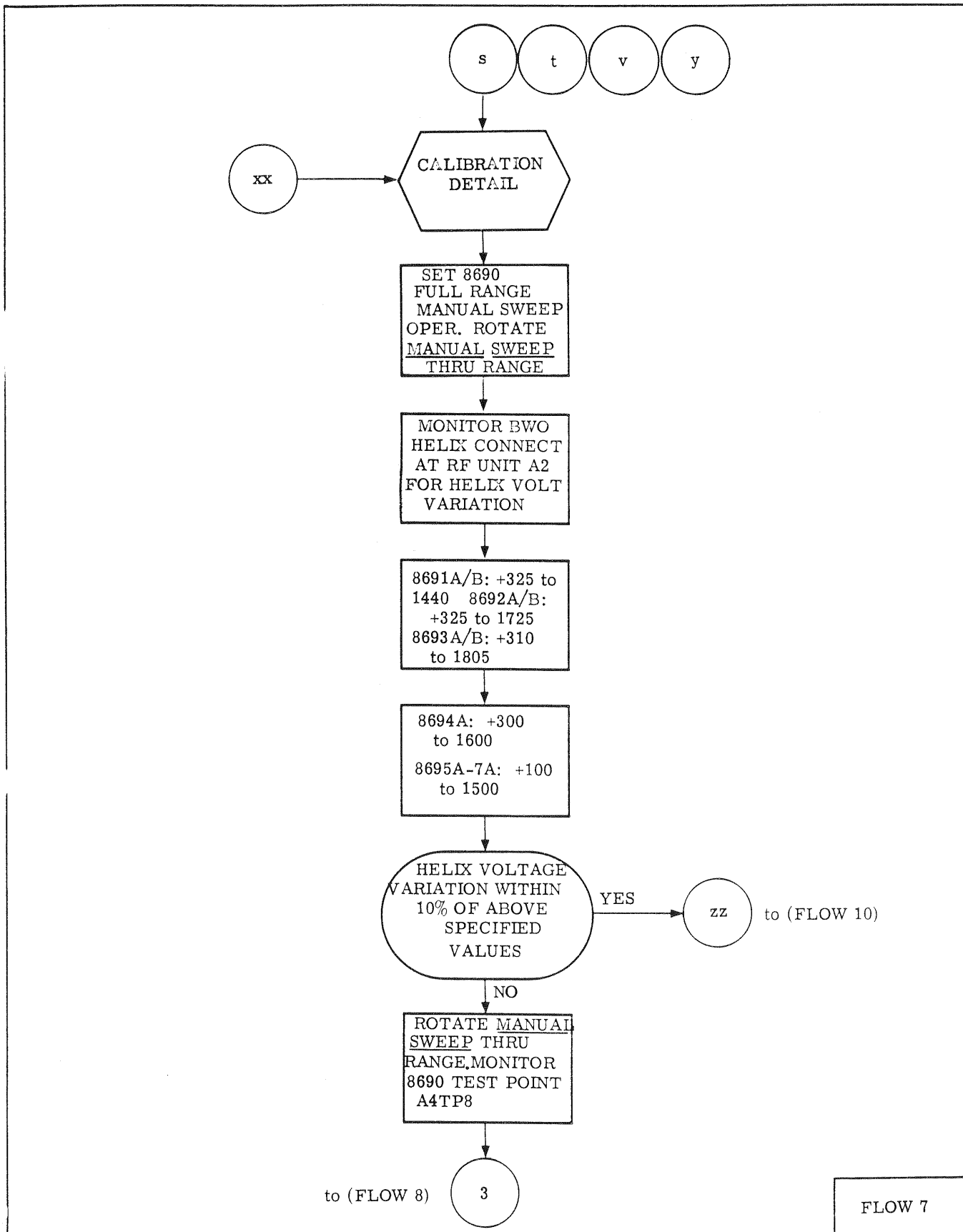

Figure 5-15. Detailed Troubleshooting Flow (Continued)

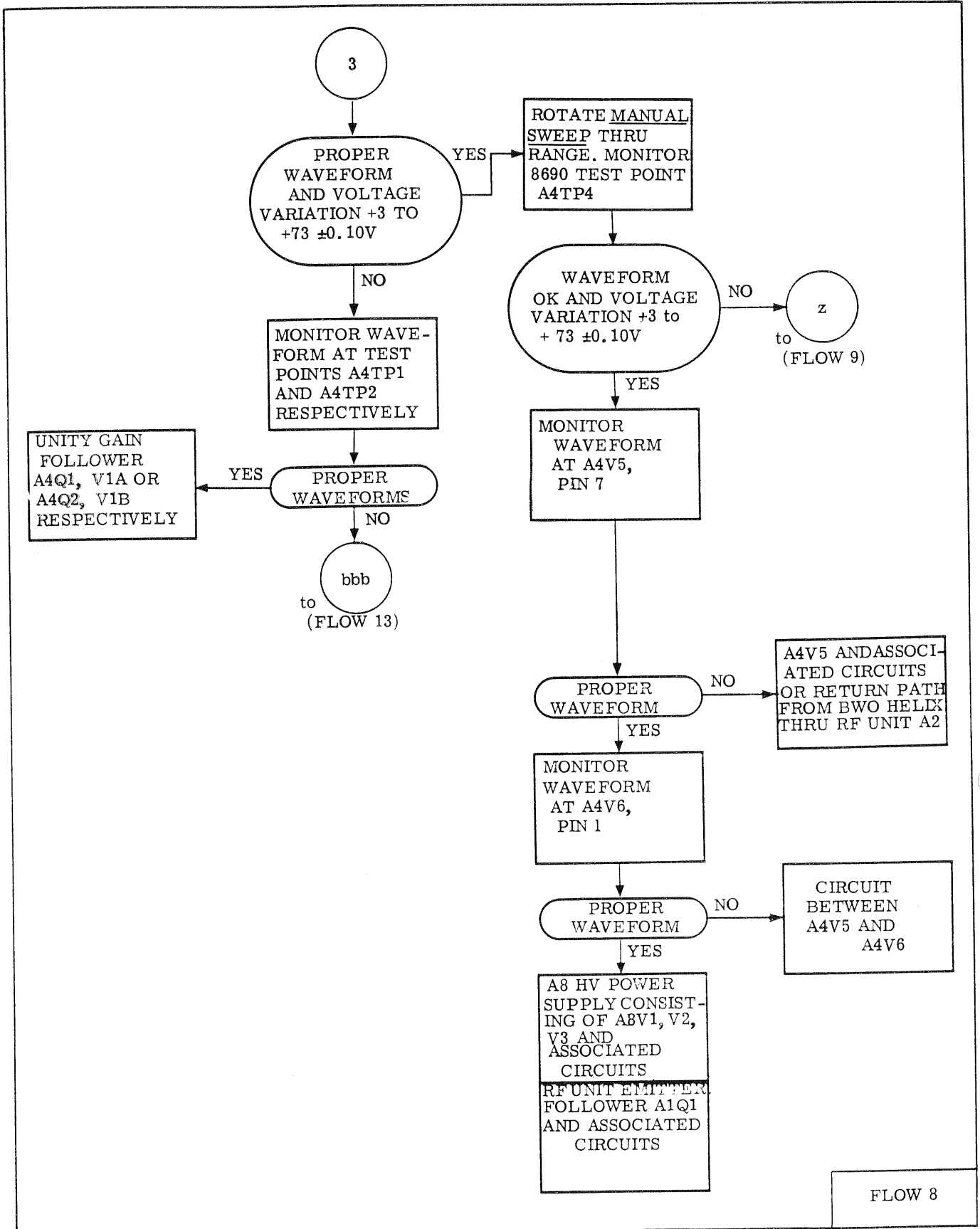
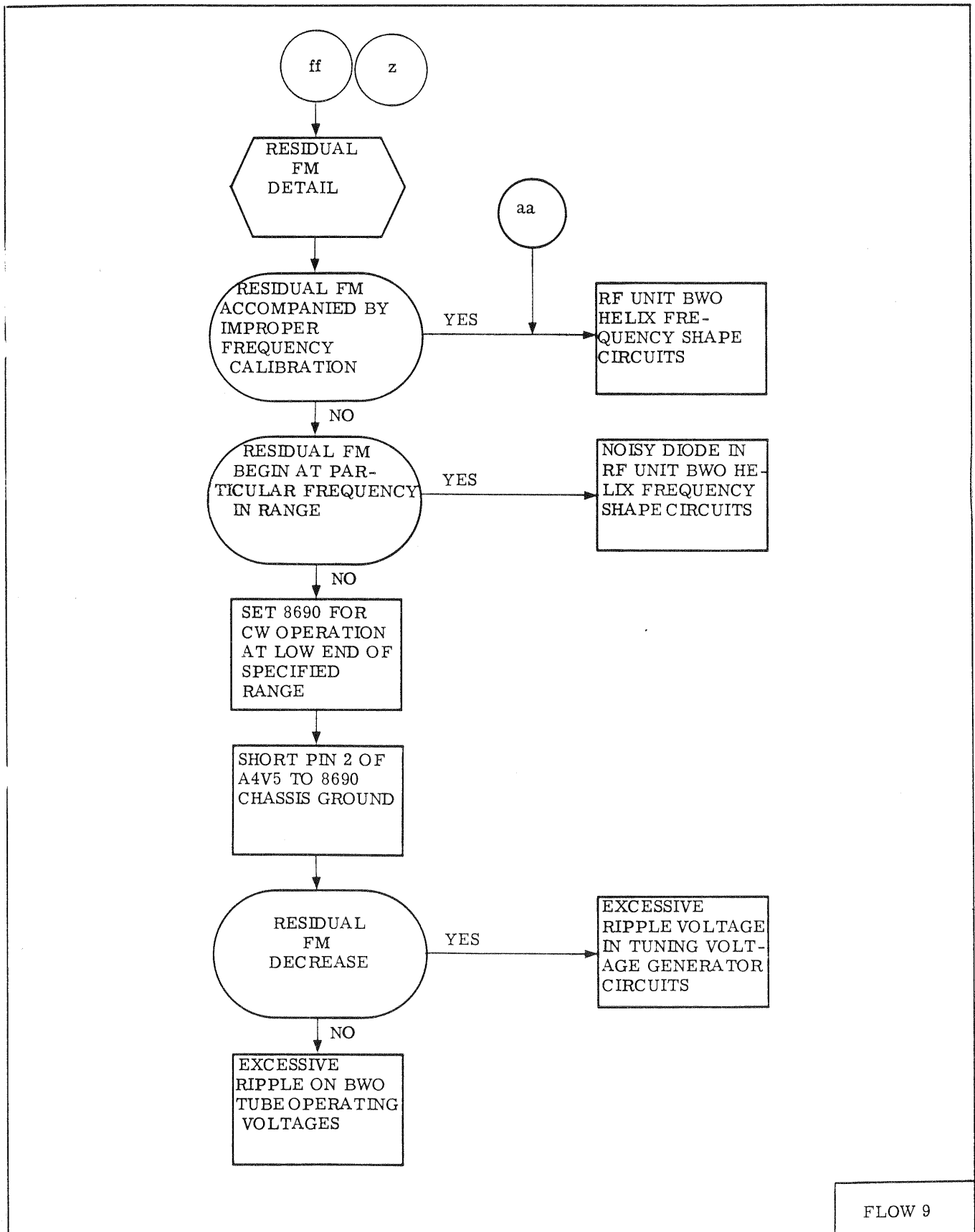

Figure 5-15. Detailed Troubleshooting Flow (Continued)



FLOW 9

Figure 5-15. Detailed Troubleshooting Flow (Continued)

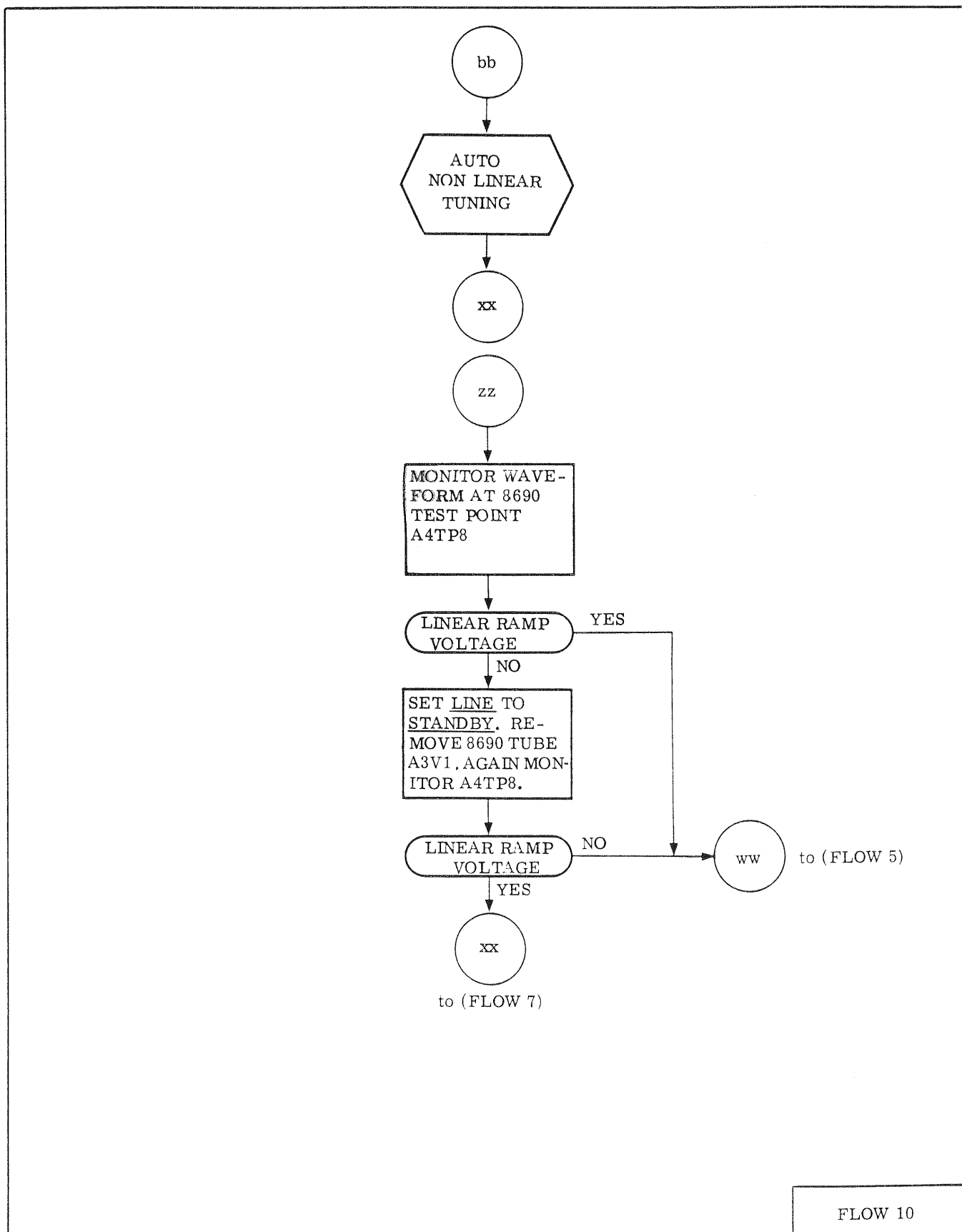

Figure 5-15. Detailed Troubleshooting Flow (Continued)

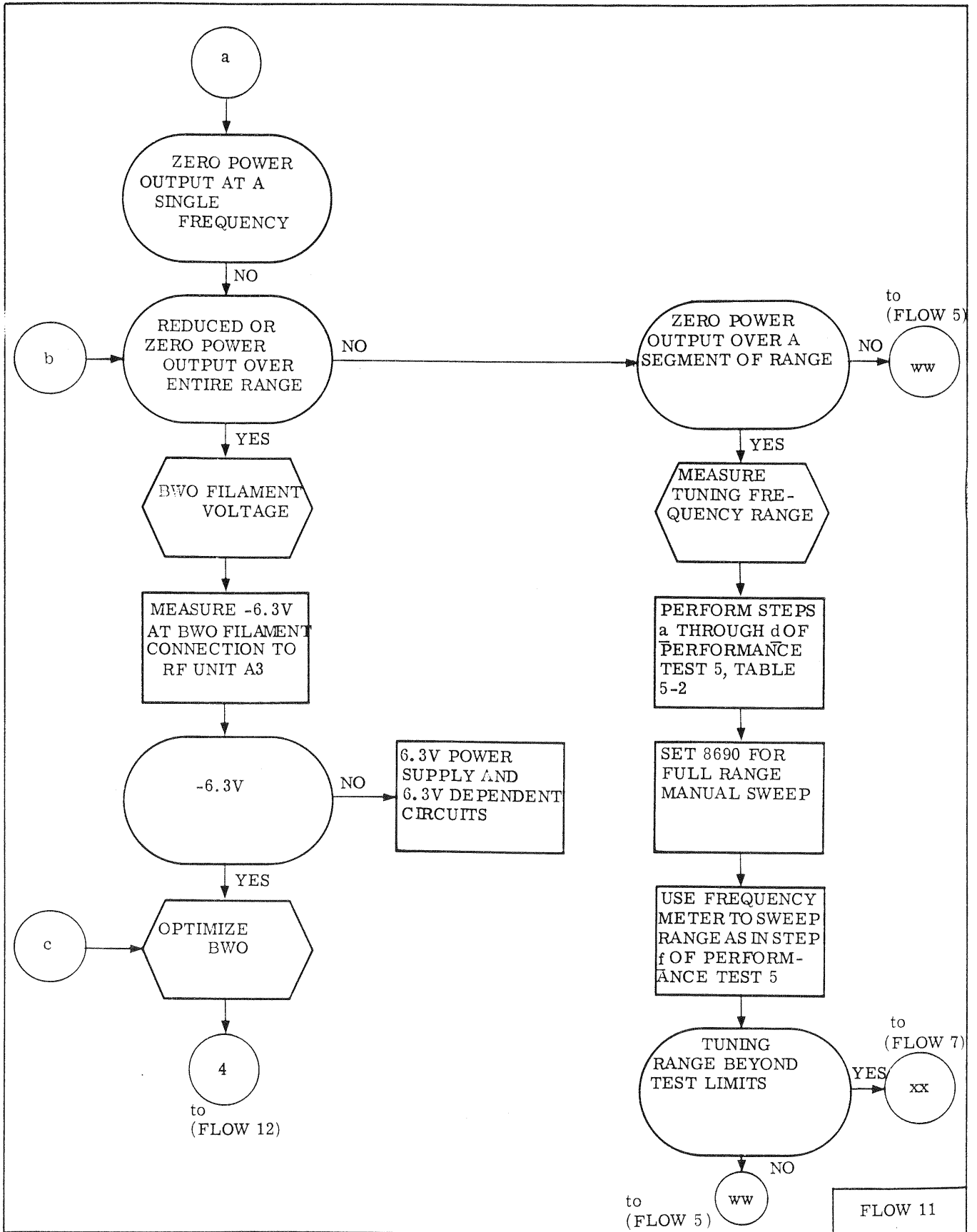

Figure 5-15. Detailed Troubleshooting Flow (Continued)

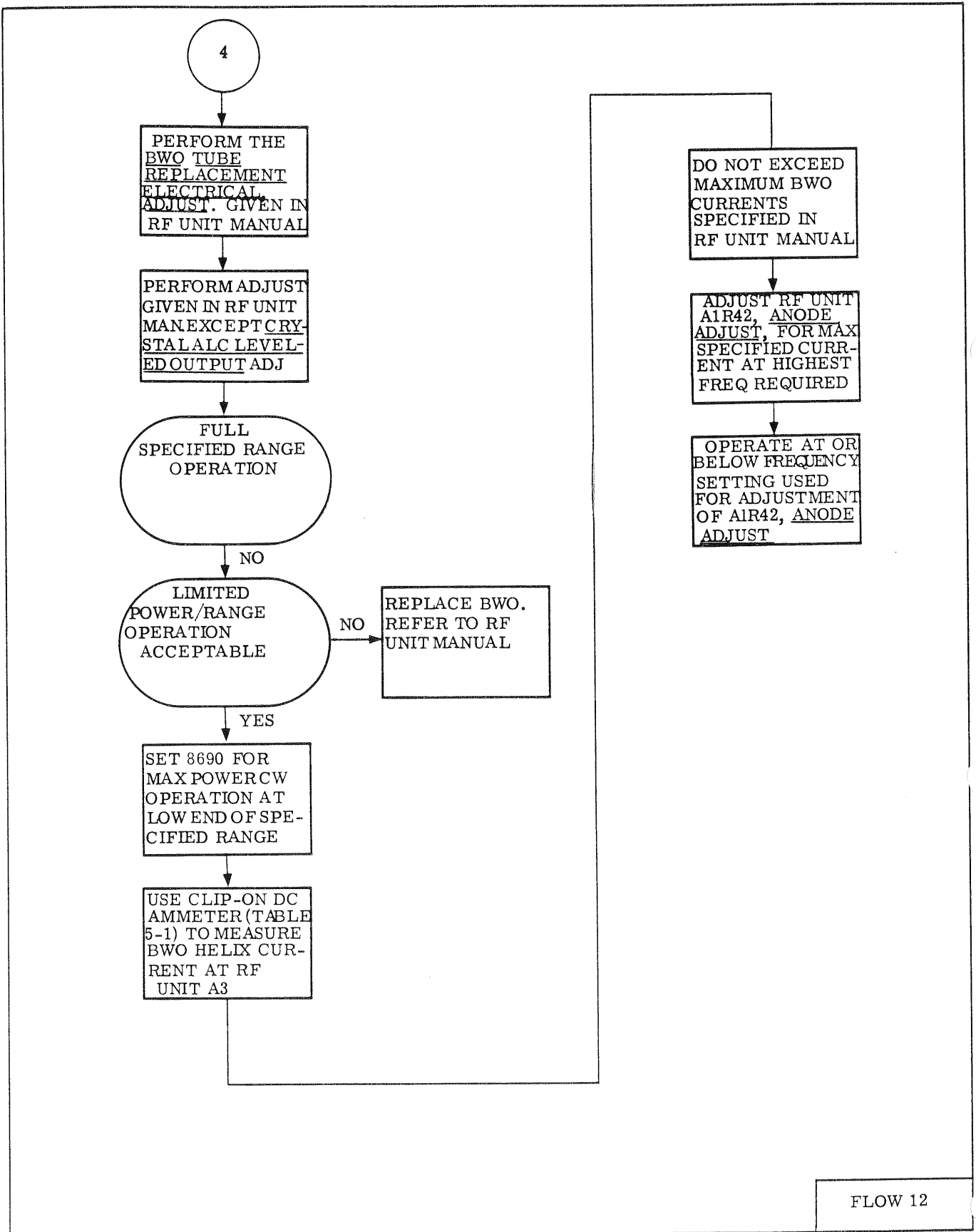

Figure 5-15. Detailed Troubleshooting Flow (Continued)

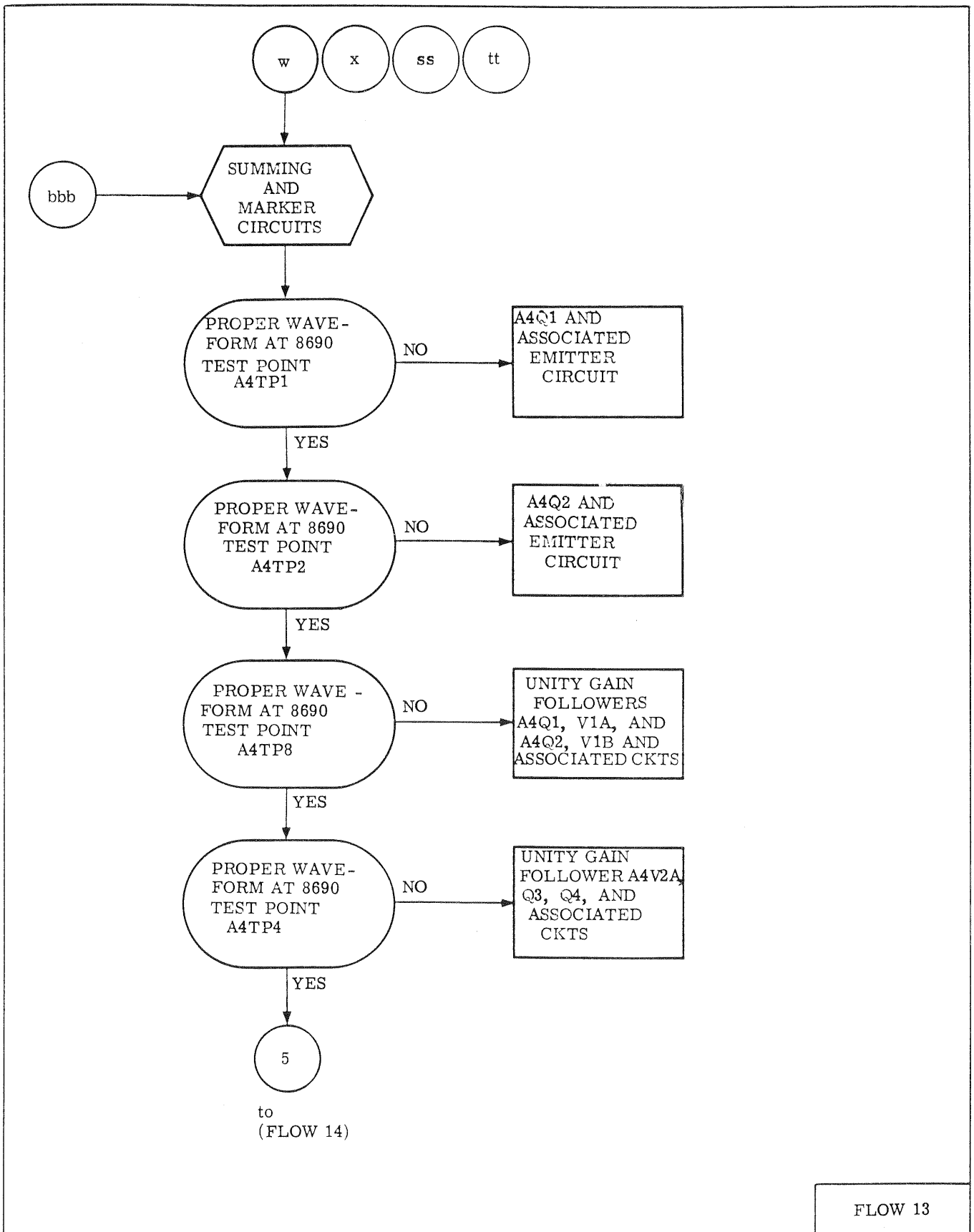
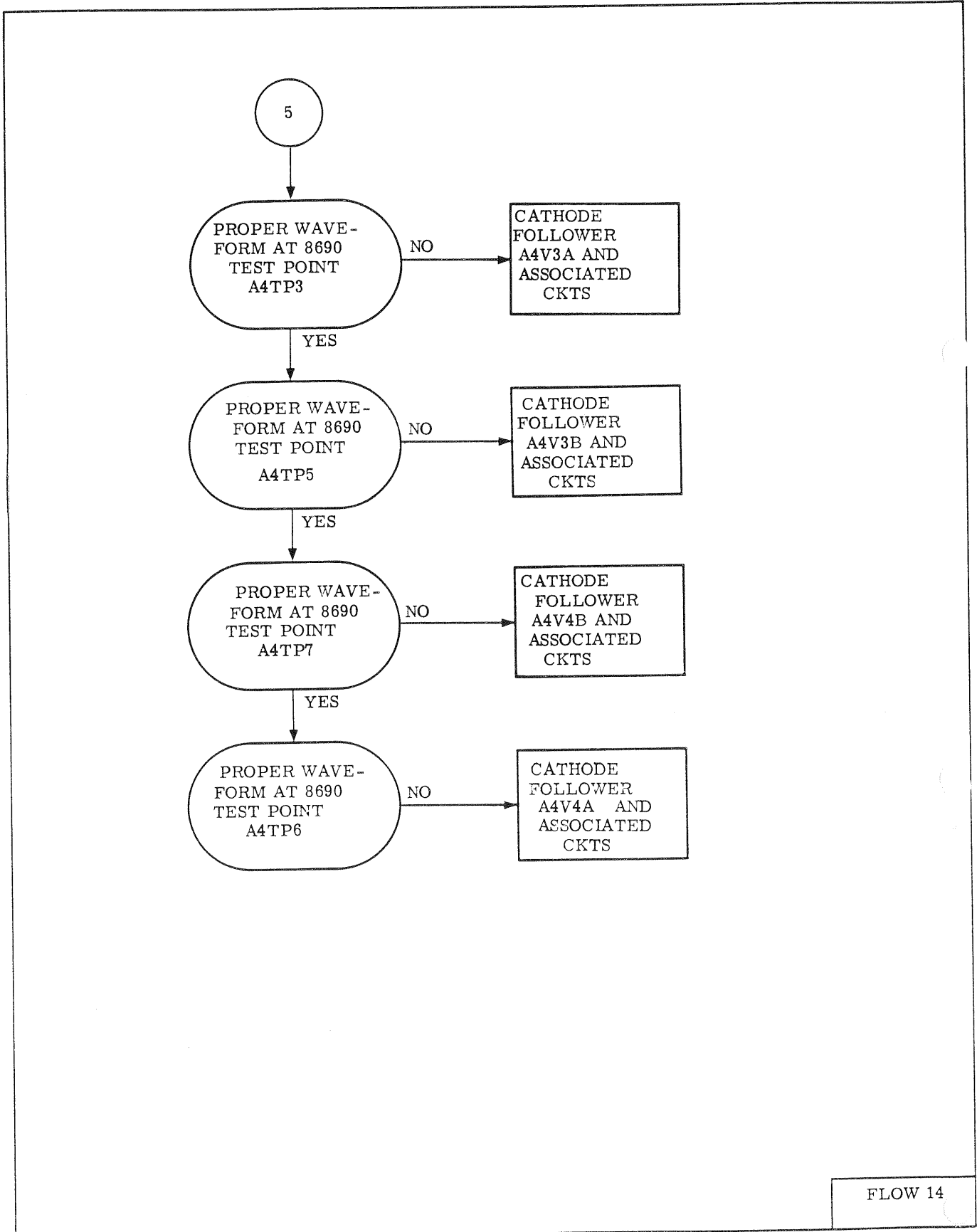
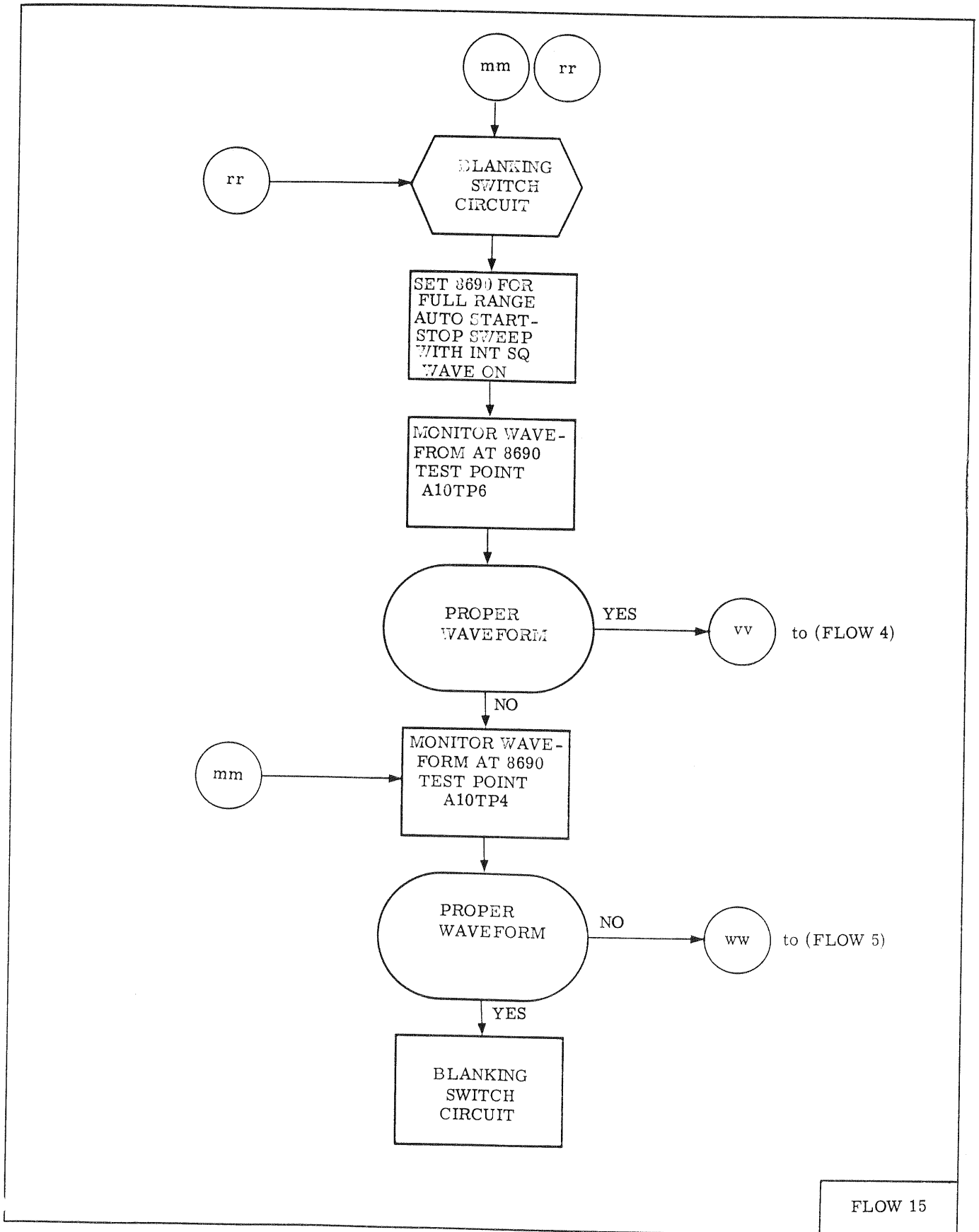

Figure 5-15. Detailed Troubleshooting Flow (Continued)



FLOW 14

Figure 5-15. Detailed Troubleshooting Flow (Continued)



FLOW 15

Figure 5-15. Detailed Troubleshooting Flow (Continued)

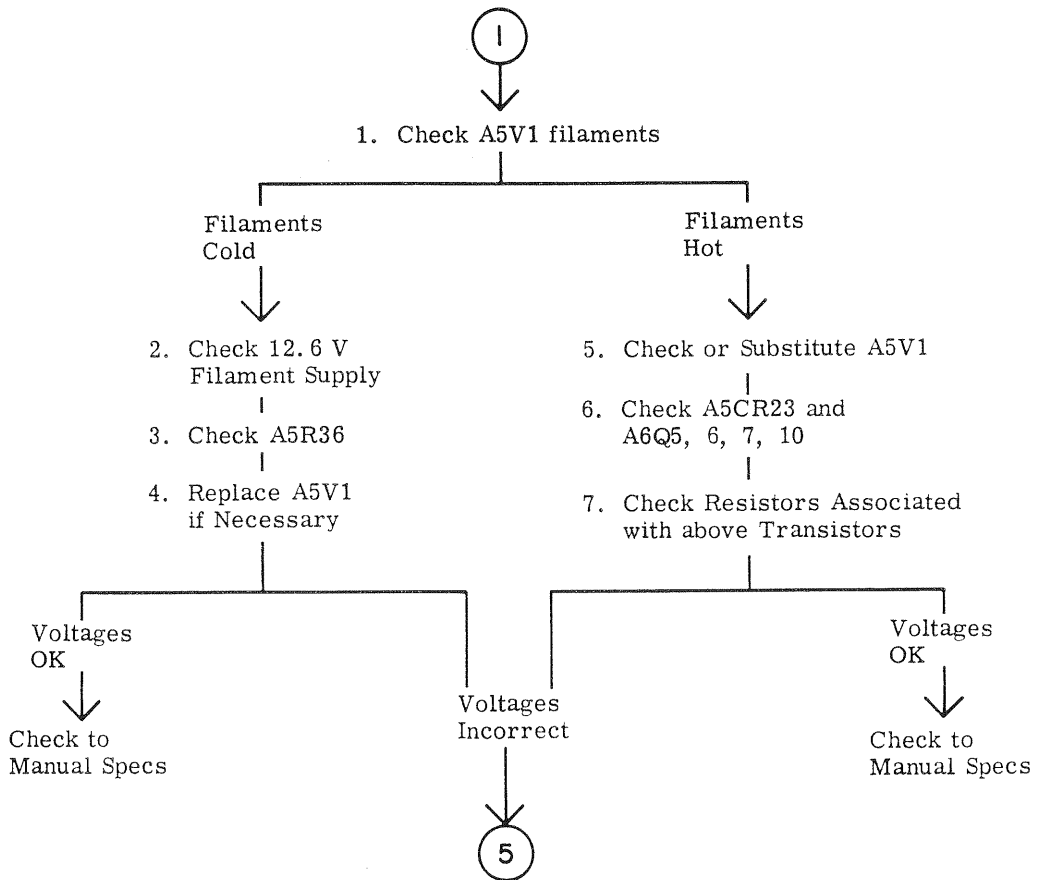
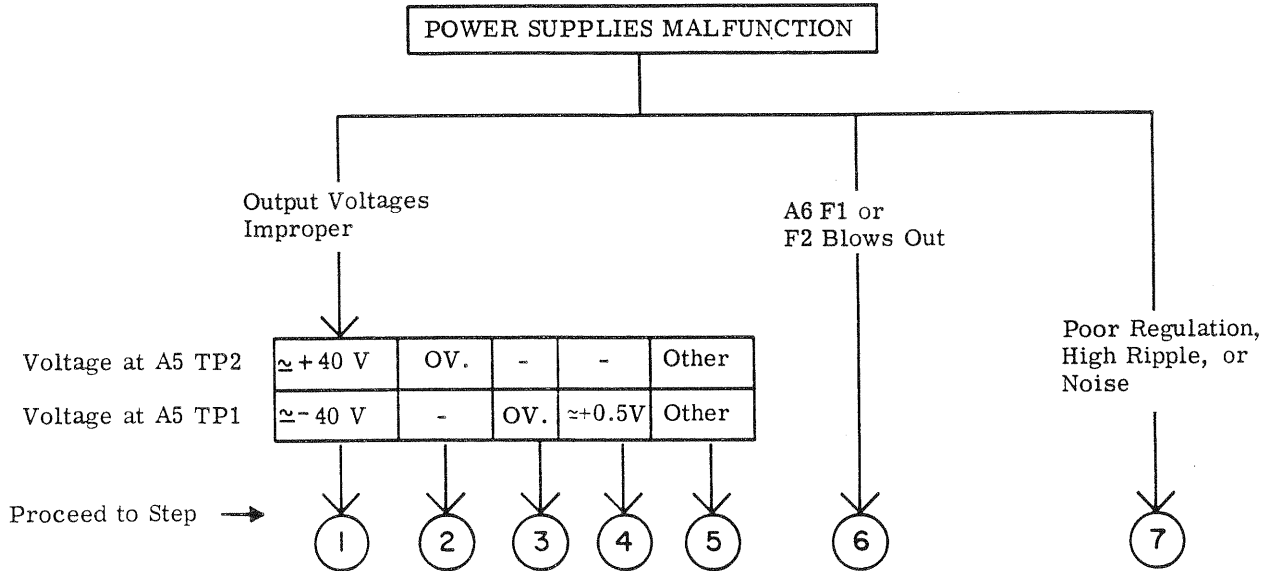

Figure 5-16. +275V and -300V Power Supply Troubleshooting Flow

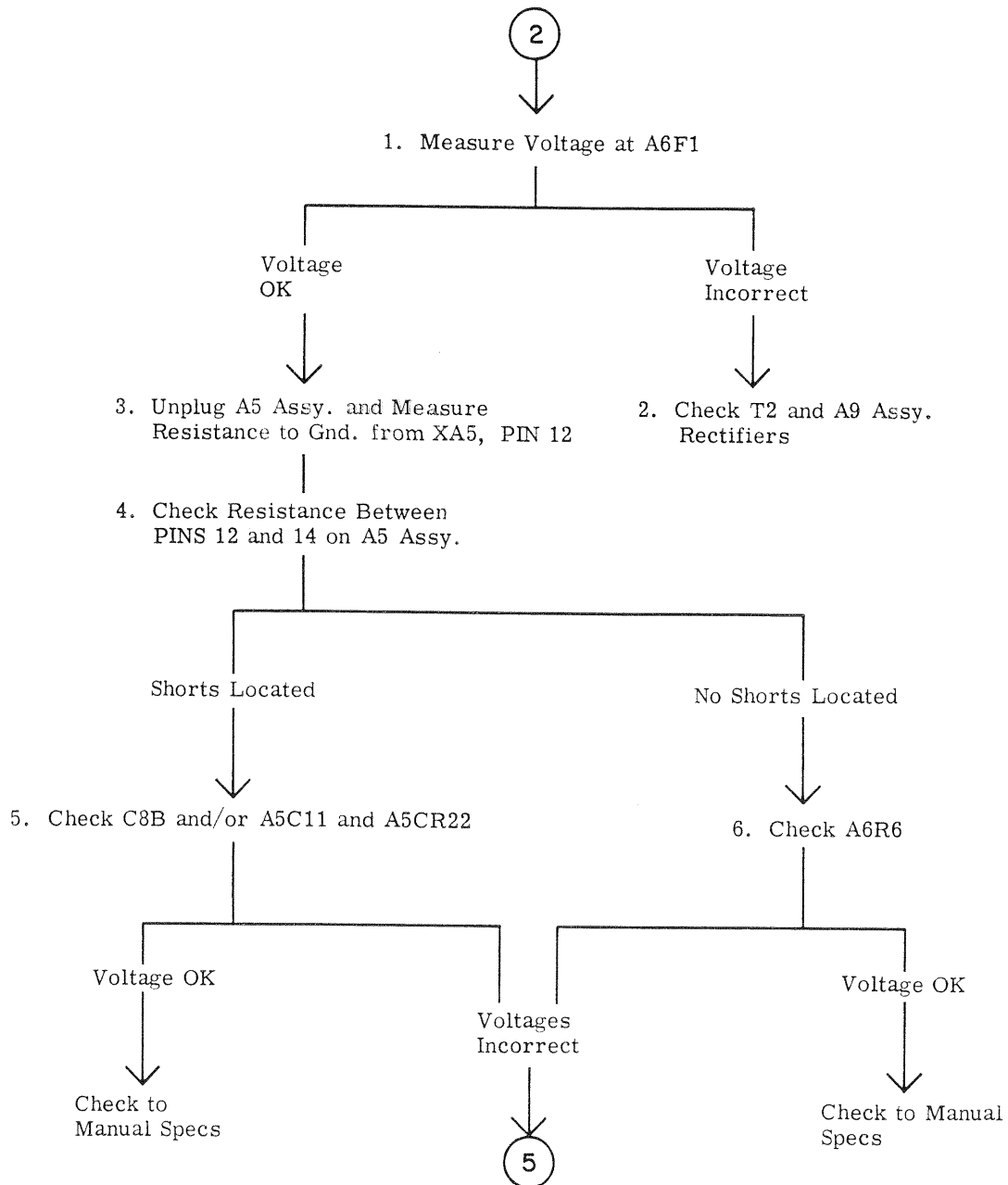

Figure 5-16. +275V and -300V Power Supply Troubleshooting Flow (Continued)

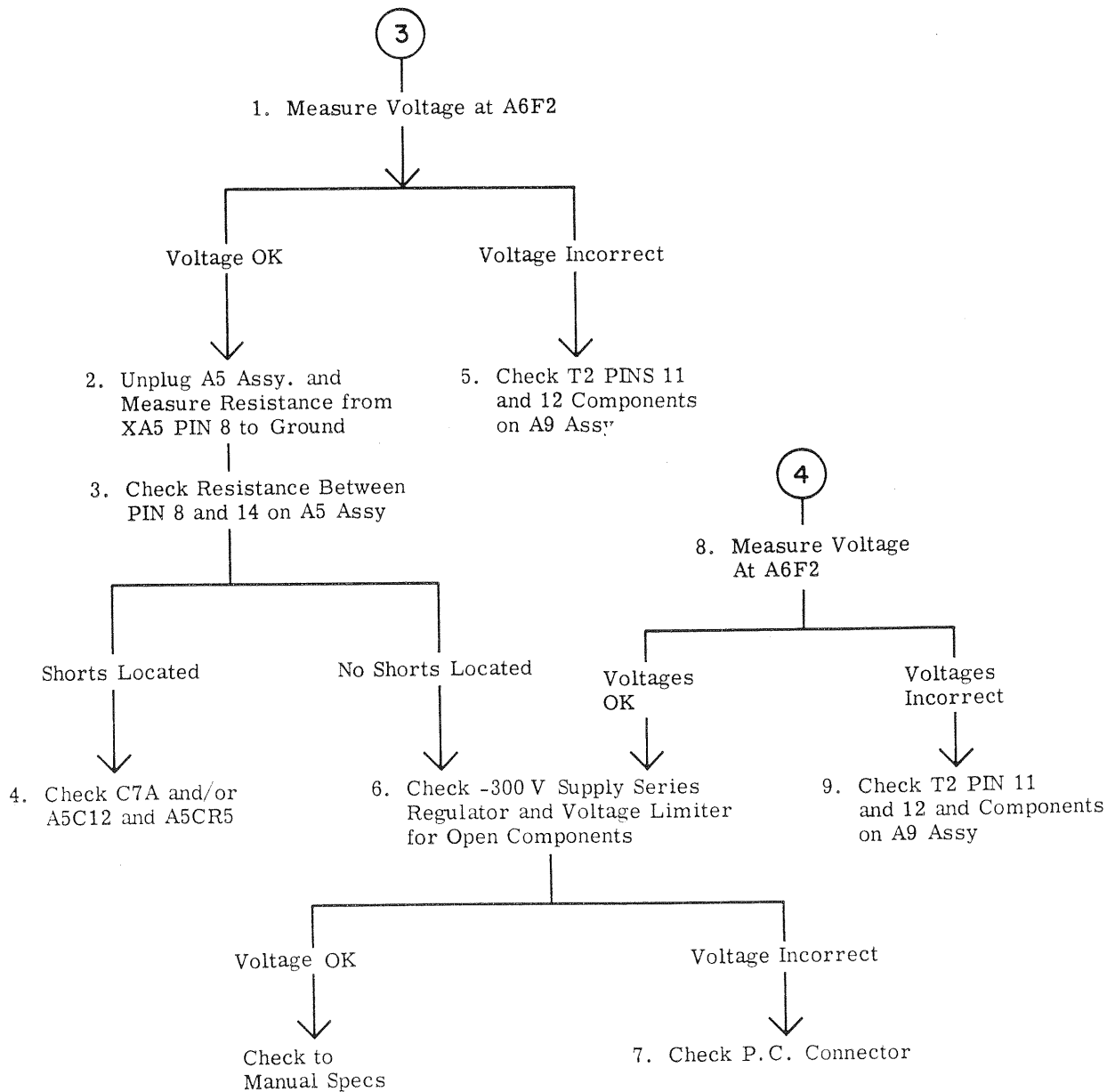

Figure 5-16. +275V and -300V Power Supply Troubleshooting Flow (Continued)

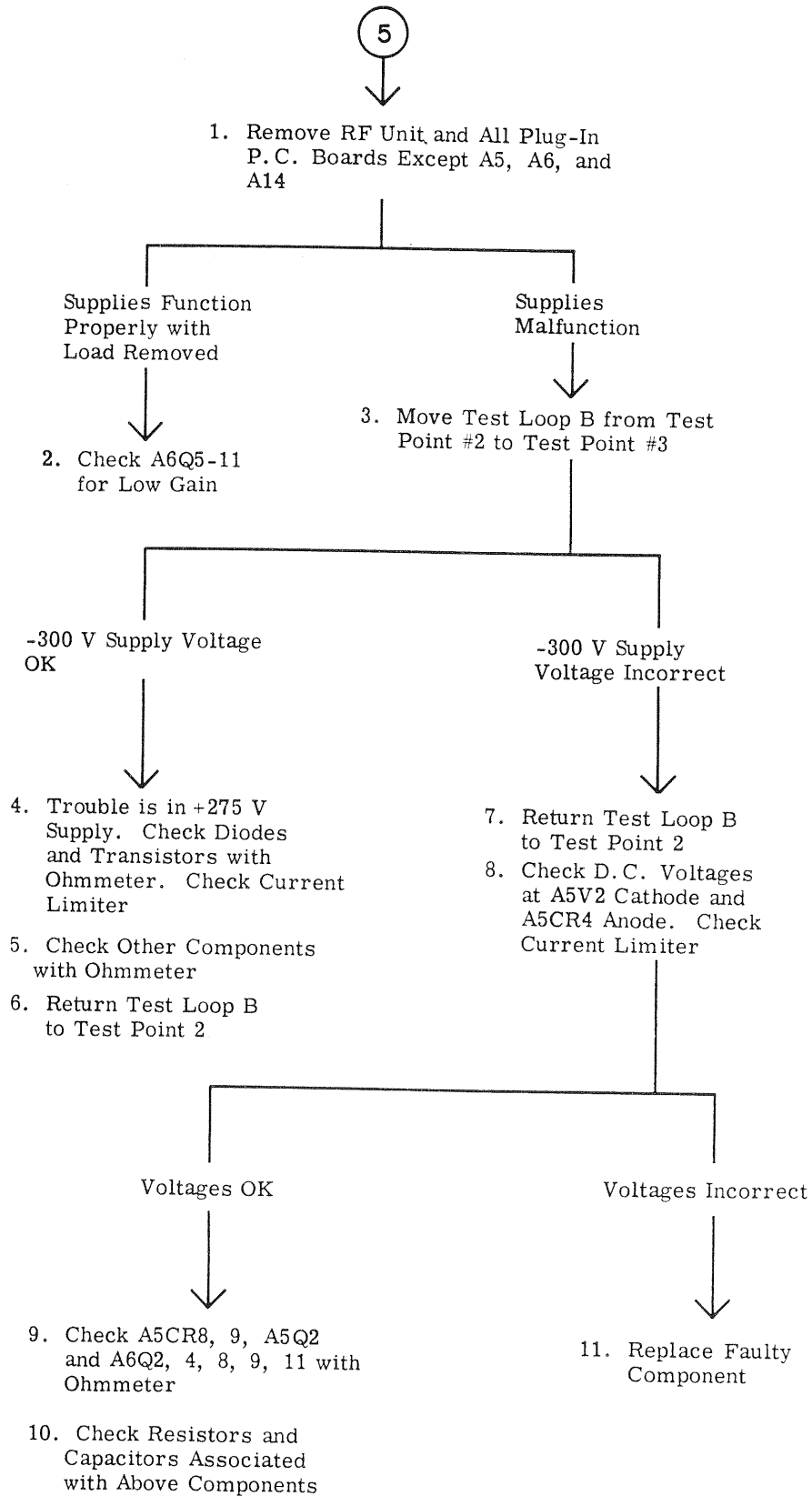

Figure 5-16. +275V and -300V Power Supply Troubleshooting Flow (Continued)

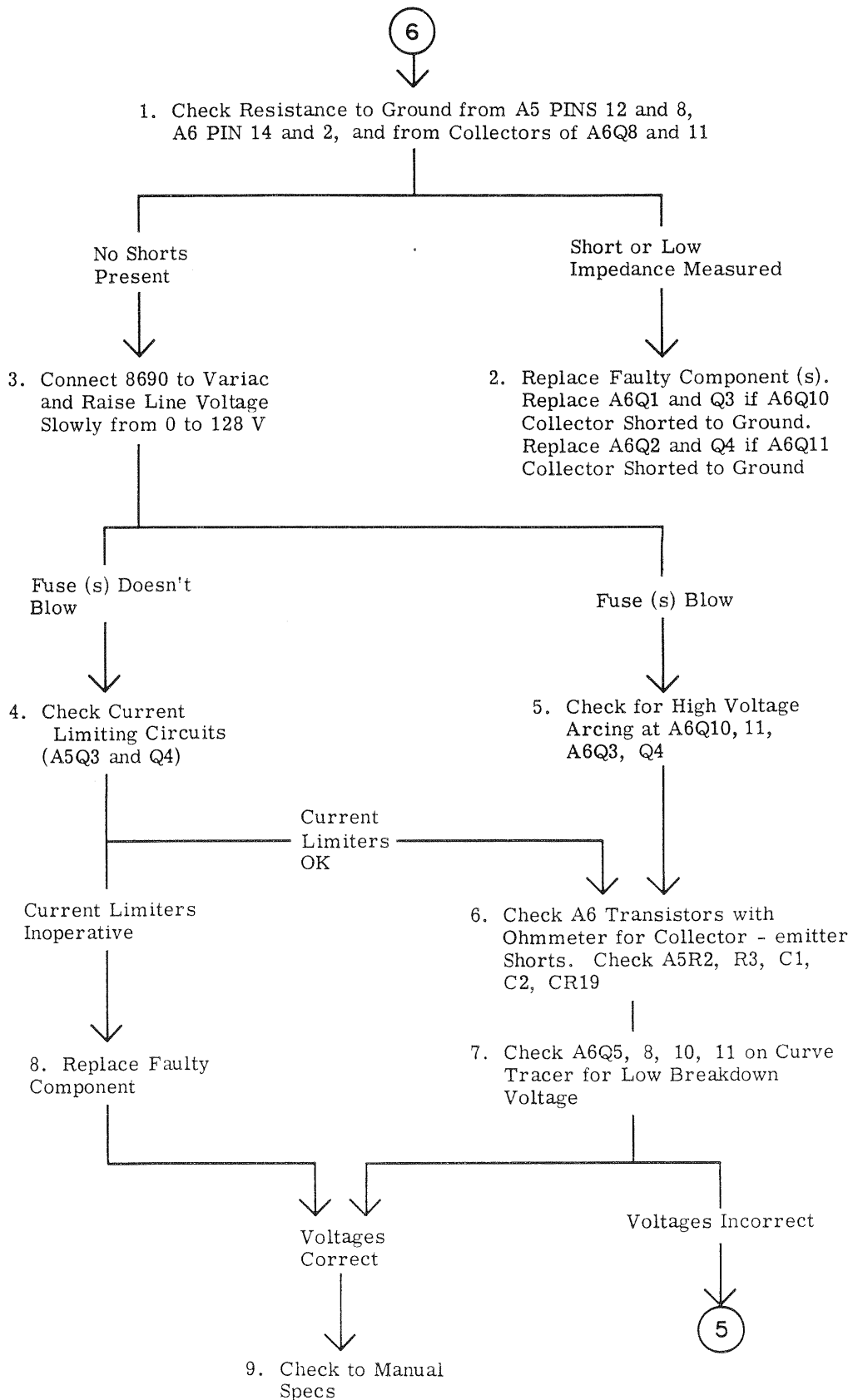

Figure 5-16. +275V and -300V Power Supply Troubleshooting Flow (Continued)

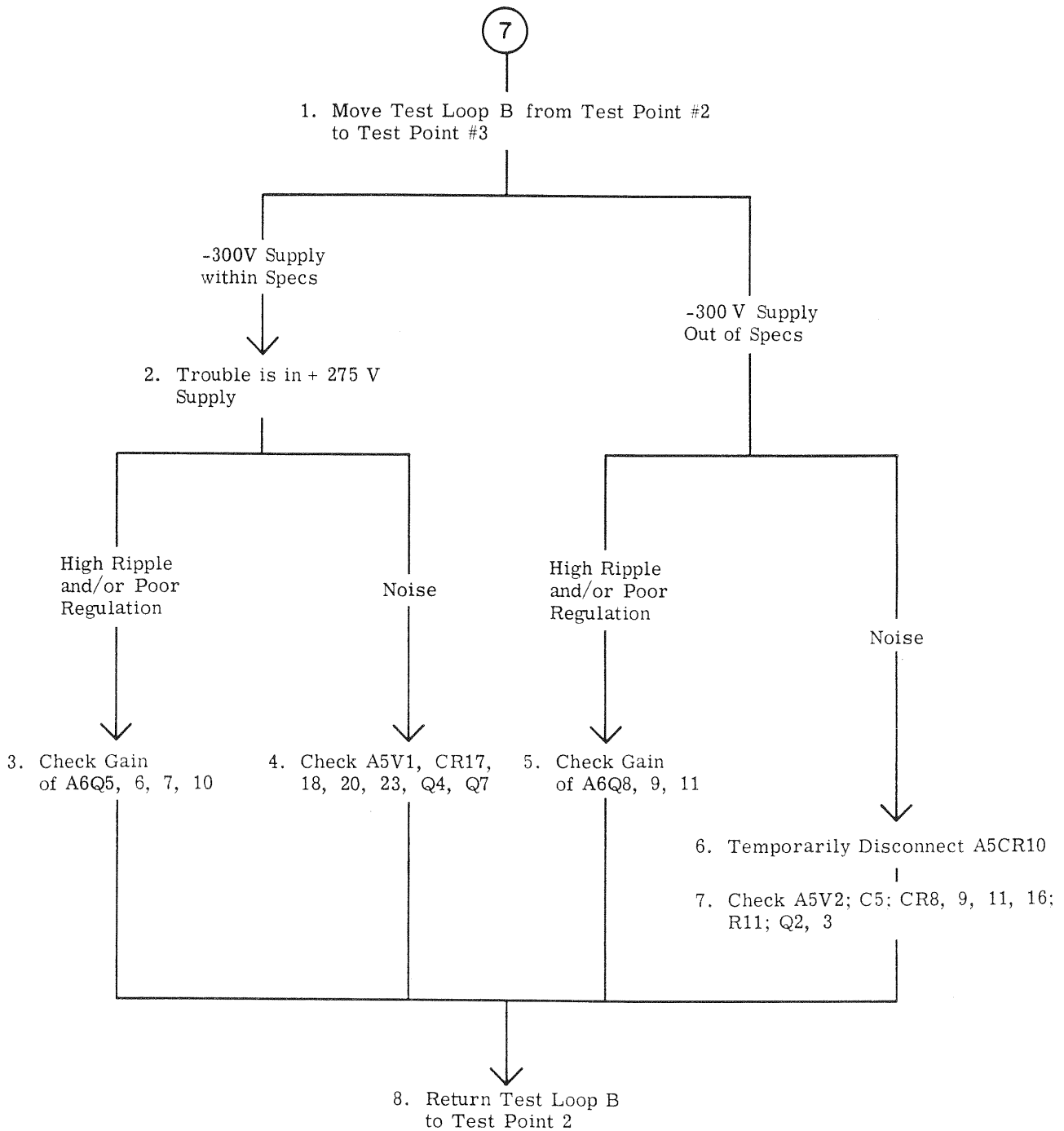

Figure 5-16. +275V and -300V Power Supply Troubleshooting Flow (Continued)

SECTION VI REPLACEABLE PARTS

6-1. INTRODUCTION.

6-2. This section contains information for ordering replacement parts. Table 6-1 lists parts in alpha-numerical order of their reference designators and indicates the description and hp stock number of each part, together with any applicable notes. Miscellaneous parts are listed at the end of Table 6-1. Table 6-2 lists parts in alpha-numerical order of their hp stock number and provides the following information on each part:

- a. Description.
- b. Manufacturer of the part in a five-digit code; see list of manufacturers in Table 6-3.
- c. Manufacturer's part number.
- d. Total quantity used (1 Q column).

6-3. ORDERING INFORMATION.

6-4. To obtain replacement parts, address order or inquiry to your local Hewlett-Packard Field Office (see list at rear of this manual for addresses). Identify parts by their Hewlett-Packard Stock numbers.

6-5. To obtain a part that is not listed, include:

- a. Instrument model number.
- b. Instrument serial number.
- c. Description of the part.
- d. Function and location of the part.

REFERENCE DESIGNATORS

A = assembly	E = misc electronic part	MP = mechanical part	TB = terminal board
B = motor	F = fuse	P = plug	TP = test point
BT = battery	FL = filter	Q = transistor	V = vacuum, tube, neon bulb, photocell, etc.
C = capacitor	J = jack	R = resistor	W = cable
CP = coupler	K = relay	RT = thermistor	X = socket
CR = diode	L = inductor	S = switch	Y = crystal
DL = delay line	M = meter	T = transformer	
DS = device signaling (lamp)			

ABBREVIATIONS

A = amperes	GE = germanium	N/C = normally closed	RMO = rack mount only
A. F. C. = automatic frequency control	GL = glass	NE = neon	RMS = root-mean square
AMPL = amplifier	GRD = ground(ed)	NI PL = nickel plate	RWV = reverse working voltage
B. F. O. = beat frequency oscillator	H = henries	N/O = normally open	S-B = slow-blow
BE CU = beryllium copper	HEX = hexagonal	NPO = negative positive zero (zero temperature coefficient)	SCR = screw
BH = binder head	HG = mercury	NRFR = not recommended for field replacement	SE = selenium
BP = bandpass	HR = hour(s)	NSR = not separately replaceable	SECT = section(s)
BRS = brass	IF = intermediate freq	OBD = order by description	SEMICON = semiconductor
BWO = backward wave oscillator	IMPG = impregnated	OH = oval head	SI = silicon
CCW = counter-clockwise	INCD = incandescent	OX = oxide	SIL = silver
CER = ceramic	INCL = include(s)	P = peak	SL = slide
CMO = cabinet mount only	INS = insulation(ed)	PC = printed circuit	SPL = special
COEF = coefficient	INT = internal	PF = picofarads = 10 ⁻¹² farads	SST = stainless steel
COM = common	K = kilo = 1000	PH BRZ = phosphor bronze	SR = split ring
COMP = composition	LEN = linear taper	PHL = Phillips	STL = steel
CONN = connector	LK WASH = lock washer	PIV = peak inverse voltage	TA = tantalum
CP = cadmium plate	LOG = logarithmic taper	P O = part of	TD = time delay
CRT = cathode-ray tube	LPF = low pass filter	POLY = polystyrene	TGL = toggle
CW = clockwise	M = milli = 10 ⁻³	PORC = porcelain	TI = titanium
DEPC = deposited carbon	MEG = meg = 10 ⁶	POS = position(s)	TOL = tolerance
DR = drive	MET FLM = metal film	POT = potentiometer	TRIM = trimmer
ELECT = electrolytic	MET OX = metallic oxide	PP = peak-to-peak	TWT = traveling wave tube
ENCAP = encapsulated	MFR = manufacturer	PT = point	U = micro = 10 ⁻⁶
EXT = external	MINAT = miniature	PWV = peak working voltage	VAR = variable
F = farads	MOM = momentary	RECT = rectifier	VDCW = dc working volts
FH = flat head	MTG = mounting	RF = radio frequency	W = with
FIL H = fillister head	MY = "mylar"	RH = round head	W = watts
FXD = fixed	N = nano (10 ⁻⁹)	RIV = reverse inverse voltage	WIV = working inverse voltage
			WW = wirewound
			W O = without

Table 6-1. Reference Designation Index

Reference Designation	Part No.	Description #	Note
A1	08690-6040	BOARD ASSY:TRIMPOT	
A1R1 THRU A1R4 A1R5	2100-1758 0698-3444	R:VAR WW 1K OHM 10% LIN 1/2W R:FXD MET FLM 316 OHM 1% 1/8W	
A2	08690-6012	BOARD ASSY:CALIBRATOR	
A2C1	0150-0052	C:FXD CER 0.05 UF 20% 400VDCW	
A2C2	0150-0012	C:FXD CER 0.01 UF 20% 1000VDCW	
A2C3	0160-2675	C:FXD MICA 8900 PF 1% 300VDCW ,FACTORY SELECTED PART	
A2C4	0170-0073	C:FXD MY 1UF 10% 600VDCW	
A2C5	0170-0022	C:FXD MY 0.1UF 20% 600VDCW	
A2C6	0160-0381	C:FXD MY 0.01 UF 10% 400VDCW	
A2C7	0160-0382	C:FXD MY 0.001 UF 10% 400VDCW	
A2C8	0140-0145	C:FXD MICA 22 PF 5%	
A2C9	0180-0197	C:FXD ELECT 2.2 UF 10% 20VDCW	
A2C10	0160-2120	C:FXD MICA 0.01 UF 1%	
A2CR1	1901-0033	DIODE:SILICON 100MA 180WV	
A2CR2	1901-0033	DIODE:SILICON 100MA 180WV	
A2CR3	1901-0033	DIODE:SILICON 100MA 180WV	
A2CR4	1901-0028	DIODE:SILICON 400 PIV 0.5 AMP	
A2CR5	1901-0033	DIODE:SILICON 100MA 180WV	
A2CR6	1901-0096	DIODE:SILICON 120V	
A2CR7	1901-0096	DIODE:SILICON 120V	
A2CR8	1901-0033	DIODE:SILICON 100MA 180WV	
A2O1	1854-0003	TRANSISTOR:NPN SILICON	
A2R1	0757-0442	R:FXD MET FLM 10.0K OHM 1% 1/8W	
A2R2	0687-8241	R:FXD COMP 820K OHM 10% 1/2W	
A2R3	0757-0482	R:FXD MET FLM 511K OHM 1% 1/8W	
A2R4	0727-0292	R:FXD CARBON 3 MEGOHM 1% 1/2W	
A2R5	0757-0461	R:FXD MET FLM 68.1K OHM 1% 1/8W	
A2R6	0698-3453	R:FXD MET FLM 196K OHM 1% 1/8W	
A2R7	0757-0461	R:FXD MET FLM 68.1K OHM 1% 1/8W	
A2R8	2100-0361	R:VAR COMP 2000 OHM 30% LIN 1/8W	
A2R9	0757-0442	R:FXD MET FLM 10.0K OHM 1% 1/8W	
A2R10	0757-0136	R:FXD MET FLM 619K OHM 1% 1/2W	
A2R11	0757-0280	R:FXD MET FLM 1K OHM 1% 1/8W	
A2R12		NOT ASSIGNED	
A2R13	0727-0292	R:FXD CARBON 3 MEGOHM 1% 1/2W	
A2R14		NOT ASSIGNED	
A2R15	0698-3425	R:FXD MET FLM 316K OHM 1% 1/2W	
A2R16	0757-0465	R:FXD MET FLM 100K OHM 1% 1/8W	
A2R17	0757-0442	R:FXD MET FLM 10.0K OHM 1% 1/8W	
A2R18	0698-3160	R:FXD MET FLM 31.6K OHM 1% 1/8W	
A2R19	2100-1473	R:VAR COMP 15K OHM 30% LIN 1/8W	
A2R20	0757-0431	R:FXD MET FLM 2.43K OHM 1% 1/8W	
A2R21	0698-3155	R:FXD MET FLM 4.64K OHM 1% 1/8W	
A2R22	2100-1474	R:VAR COMP 5K OHM 30% LIN 1/8W	
A2R23	2100-1474	R:VAR COMP 5K OHM 30% LIN 1/8W	
A2R24	2100-1474	R:VAR COMP 5K OHM 30% LIN 1/8W	
A2R25	2100-0361	R:VAR COMP 2000 OHM 30% LIN 1/8W	

See introduction to this section for ordering information

Table 6-1. Reference Designation Index (Cont.)

Reference Designation	Part No.	Description #	Note
A2R26	0757-0457	R:FXD MET FLM 47.5K OHM 1% 1/8W	
A2R27	0757-0352	R:FXD MET FLM 150K OHM 1% 1/2W	
A2R28	2100-1471	R:VAR COMP 50K OHM 30% LIN 1/8W	
A2R29		NOT ASSIGNED	
A2R30	2100-1474	R:VAR COMP 5K OHM 30% LIN 1/8W	
A2R31	2100-1474	R:VAR COMP 5K OHM 30% LIN 1/8W	
A2R32	0757-0862	R:FXD MET FLM 221K OHM 1% 1/2W	
A2R33	0757-0415	R:FXD MET FLM 475 OHM 1% 1/8W, FACTORY SELECTED PART	
A2R34	0757-0415	R:FXD MET FLM 475 OHM 1% 1/8W	
A2R35	0757-0415	R:FXD MET FLM 475 OHM 1% 1/8W	
A2R36	0757-0280	R:FXD MET FLM 1K OHM 1% 1/8W	
A2R37		NOT ASSIGNED	
A2R38	2100-1760	R:VAR WW 5K OHM 10% LIN 1/2W	
A2R39	0757-0280	R:FXD MET FLM 1K OHM 1% 1/8W	
A2R40	0757-0135	R:FXD MET FLM 511K OHM 1% 1/2W	
A3	08690-6034	BOARD ASSY:RECIPROCAL AMPLIFIER	
A3C1-		NOT ASSIGNED	
A3C9		NOT ASSIGNED	
A3C10	0180-0269	C:FXD ELECT 1.0 UF +50-10% 150VDCW	
A3C11	0180-0051	C:FXD ELECT 8 UF 350VDCW	
A3C12-		NOT ASSIGNED	
A3C39		NOT ASSIGNED	
A3C40	0170-0055	C:FXD MY 0.1UF 20% 200VDCW	
A3C41	0150-0012	C:FXD CER 0.01 UF 20% 1000VDCW	
A3C42	0140-0193	C:FXD MICA 82 PF 5% FACTORY SELECTED PART	
A3C43	0140-0216	C:FXD MICA 120 PF 2%	
A3C44	0160-2218	C:FXD MICA 1000 PF 5%	
A3C45	0160-2225	C:FXD MICA 2000 PF 5% 300VDCW	
A3C46	0150-0052	C:FXD CER 0.05 UF 20% 400VDCW	
A3C47	0150-0052	C:FXD CER 0.05 UF 20% 400VDCW	
A3CR1-		NOT ASSIGNED	
A3CR6		NOT ASSIGNED	
A3CR7	1901-0356	DIODE:SILICON 250WV	
A3CR8	1901-0029	DIODE:SILICON 600 PIV	
A3CR9-		NOT ASSIGNED	
A3CR40		NOT ASSIGNED	
A3CR41	1901-0033	DIODE:SILICON 100MA 180WV	
A3CR42	1901-0033	DIODE:SILICON 100MA 180WV	
A3CR43	1901-0033	DIODE:SILICON 100MA 180WV	
A3CR44	1902-3139	DIODE BREAKDOWN:SILICON 8.25V 5%	
A3CR45	1902-3139	DIODE BREAKDOWN:SILICON 8.25V 5%	
A3CR46	1902-3323	DIODE BREAKDOWN:42.2V 5%	
A3CR47	1902-3323	DIODE BREAKDOWN:42.2V 5%	
A3CR48	1902-0176	DIODE BREAKDOWN:47.5V 1W	

See introduction to this section for ordering information

Table 6-1. Reference Designation Index (Cont.)

Reference Designation	Part No.	Description #	Note
A3CR49	1902-3182	DIODE BREAKDOWN:SILICON 12.1V 5%	
A3CR50	1901-0033	DIODE:SILICON 100MA 180WV	
A3CR51	1901-0033	DIODE:SILICON 100MA 180WV	
A3CR52	1901-0033	DIODE:SILICON 100MA 180WV	
A3CR53	1901-0033	DIODE:SILICON 100MA 180WV	
A3CR54	1902-3002	DIODE BREAKDOWN:2.37V 5%	
A3CR55	1902-0176	DIODE BREAKDOWN:47.5V 1W	
A3K1	0490-0323	RELAY:4PDT	
A3Q1	1855-0062	TRANSISTOR:FIELD EFFECT 30V	
A3Q2	1855-0049	TRANSISTOR:DUAL N CHANNEL	
A3Q3	1853-0038	TRANSISTOR:SILICON PNP	
A3Q4	1853-0038	TRANSISTOR:SILICON PNP	
A3Q5	1853-0020	TRANSISTOR:SILICON PNP	
A3Q6	1854-0232	TRANSISTOR:SILICON NPN	
A3R1-		NOT ASSIGNED	
A3R29		NOT ASSIGNED	
A3R30	0757-0307	R:FXD MET FLM 332K OHM 1% 1/2W	
A3R31	0757-0839	R:FXD MET FLM 10K OHM 1% 1/2W	
A3R32	0757-0307	R:FXD MET FLM 332K OHM 1% 1/2W	
A3R33	0757-0839	R:FXD MET FLM 10K OHM 1% 1/2W	
A3R34	0698-3430	R:FXD MET FLM 21.5 OHM 1% 1/8W	
A3R35-		NOT ASSIGNED	
A3R39		NOT ASSIGNED	
A3R40	0757-0136	R:FXD MET FLM 619K OHM 1% 1/2W	
A3R41	0757-0059	R:FXD MET FLM 1 MEGOHM 1% 1/2W	
A3R42	0698-3592	R:FXD MET FLM 10.0 MEGOHM 1% 1/2W	
A3R43	0757-0474	R:FXD MET FLM 243K OHM 1% 1/8W	
A3R44	0757-0474	R:FXD MET FLM 243K OHM 1% 1/8W	
A3R45	0698-3647	R:FXD MET OX 15K OHM 5% 2W	
A3R46		NOT ASSIGNED	
A3R47	0757-0428	R:FXD MET FLM 1.62K OHM 1% 1/8W	
		FACTORY SELECTED PART	
A3R48	0757-0856	R:FXD MET FLM 75.0K OHM 1% 1/2W	
A3R49	0698-3451	R:FXD MET FLM 133K OHM 1% 1/8W	
A3R50	2100-1760	R:VAR WW 5K OHM 10% LIN 1/2W	
A3R51	0698-3451	R:FXD MET FLM 133K OHM 1% 1/8W	
A3R52	0757-0457	R:FXD MET FLM 47.5K OHM 1% 1/8W	
A3R53	2100-1473	R:VAR COMP 15K OHM 30% LIN 1/8W	
A3R54	0757-0446	R:FXD MET FLM 15K OHM 1% 1/8W	
A3R55	0811-2993	R:FXD WW 500K OHM 1% 1/4W	
A3R56	0811-2993	R:FXD WW 500K OHM 1% 1/4W	
A3R57	0764-0031	R:FXD MET OX 47K OHM 5% 2W	
A3R58	0757-0135	R:FXD MET FLM 511K OHM 1% 1/2W	
A3R59	0757-1094	R:FXD MET FLM 1.47K OHM 1% 1/8W	
A3R60	0698-3175	R:FXD MET FLM 147K OHM 1% 1/2W	

See introduction to this section for ordering information

Table 6-1. Reference Designation Index (Cont.)

Reference Designation	Part No.	Description #	Note
A3R61	0698-3451	R:FXD MET FLM 133K OHM 1% 1/8W	
A3R62	0757-0135	R:FXD MET FLM 511K OHM 1% 1/2W	
A3R63	0757-0860	R:FXD MET FLM 121K OHM 1% 1/2W	
A3R64	0757-0289	R:FXD MET FLM 13.3K OHM 1% 1/8W	
A3R65	0757-0860	R:FXD MET FLM 121K OHM 1% 1/2W	
A3R66	0757-0459	R:FXD MET FLM 56.2K OHM 1% 1/8W	
A3R67	0757-0279	R:FXD MET FLM 3.16K OHM 1% 1/8W	
A3R68	0687-4751	R:FXD COMP 4.7 MEGOHM 10% 1/2W	
A3R69	0698-3424	R:FXD MET FLM 237K OHM 1% 1/2W	
A3R70	0764-0028	R:FXD MET OX 100K OHM 5% 2W	
A3R71	0757-0280	R:FXD MET FLM 1K OHM 1% 1/8W	
A3R72	0757-0467	R:FXD MET FLM 121K OHM 1% 1/8W	
A3R73	0686-3055	R:FXD COMP 3 MEGOHM 5% 1/2W	
A3R74	0757-1094	R:FXD MET FLM 1.47K OHM 1% 1/8W FACTORY SELECTED PART	
A3R75	2100-1760	R:VAR WW 5K OHM 10% LIN 1/2W	
A3R76	0764-0047	R:FXD MET OX 82K OHM 5% 2W	
A3R77	0757-0280	R:FXD MET FLM 1K OHM 1% 1/8W	
A3R78	0757-1094	R:FXD MET FLM 1.47K OHM 1% 1/8W	
A3R79	0757-0458	R:FXD MET FLM 51.1K OHM 1% 1/8W	
A3R80	0757-0442	R:FXD MET FLM 10K OHM 1% 1/8W	
A3V1	1923-0043	ELECTRON TUBE: 6EW6 PENTODE	
A3V2	1932-0009	ELECTRON TUBE: 5965 DUAL TRIODE	
A3V3	1940-0013	ELECTRON TUBE:82.0 +/- 1V	
A3V4	1940-0013	ELECTRON TUBE:82.0 +/- 1V	
A3	1200-0049	SOCKET:TUBE 7 PIN MINIATURE	
A3	1200-0062	SOCKET:TUBE 9 PIN MIN.	
A4	08690-6031	BOARD ASSY:HELIX AMPLIFIER	
A4C1	0140-0193	C:FXD MICA 82 PF 5%	
A4C2	0140-0195	C:FXD MICA 130 PF 5% 300 VDCW	
A4C3	0140-0201	C:FXD MICA 12 PF 5%,FACTORY SELECTED PART	
A4C4	0160-2150	C:FXD MICA 33 PF 5%,FACTORY SELECTED PART(MAY BE OMITTED)	
A4C5	0160-2218	C:FXD MICA 1000 PF 5%	
A4C6	0140-0145	C:FXD MICA 22 PF 5%	
A4C7	0180-0089	C:FXD ELECT 10UF-10%+100% 150VDCW	
A4C8	0160-0158	C:FXD MYLAR 5600PF 10%	
A4C9	0160-2217	C:FXD MICA 910 PF 5%	
A4CR1	1901-0033	DIODE:SILICON 100MA 180WV	
A4CR2	1901-0033	DIODE:SILICON 100MA 180WV	
A4CR3	1901-0033	DIODE:SILICON 100MA 180WV	
A4CR4-		NOT ASSIGNED	
A4CR5		NOT ASSIGNED	
A4CR6	1901-0033	DIODE:SILICON 100MA 180WV	
A4CR7	1901-0033	DIODE:SILICON 100MA 180WV	

See introduction to this section for ordering information

Table 6-1. Reference Designation Index (Cont.)

Reference Designation	Part No.	Description #	Note
A4CR8	1902-0038	DIODE BREAKDOWN:45.3V 5%	
A4CR9	1901-0033	DIODE:SILICON 100MA 180WV	
A4CR10	1901-0033	DIODE:SILICON 100MA 180WV	
A4Q1	1854-0071	TRANSISTOR:SILICON NPN	
A4Q2	1854-0071	TRANSISTOR:SILICON NPN	
A4Q3		NOT ASSIGNED	
A4Q4	1854-0071	TRANSISTOR:SILICON NPN	
A4Q5	1854-0071	TRANSISTOR:SILICON NPN	
A4Q6	1853-0020	TRANSISTOR:SILICON PNP	
A4Q7	1853-0020	TRANSISTOR:SILICON PNP	
A4R1	0761-0033	R:FXD MET OX 220K OHM 5% 1W	
A4R2	0757-0374	R:FXD MET FLM 485K OHM 1% 1/2W	
A4R3	0811-2993	R:FXD WW 500K OHM 1% 1/4W	
A4R4	0811-2993	R:FXD WW 500K OHM 1% 1/4W	
A4R5	0757-0374	R:FXD MET FLM 485K OHM 1% 1/2W	
A4R6	0757-0446	R:FXD MET FLM 15K OHM 1% 1/8W	
A4R7	0761-0033	R:FXD MET OX 220K OHM 5% 1W	
A4R8	0761-0033	R:FXD MET OX 220K OHM 5% 1W	
A4R9	0761-0040	R:FXD MET OX 150K OHM 5% 1W	
A4R10	0687-1261	R:FXD COMP 12 MEGOHM 10% 1/2W	
A4R11	0757-0465	R:FXD MET FLM 100K OHM 1% 1/8W	
A4R12	0698-3464	R:FXD MET FLM 1.47 MEGOHM 1% 1/2W	
A4R13	0757-0313	R:FXD MET FLM 392K OHM 1% 1/2W	
A4R14	0757-0156	R:FXD MET FLM 1.5 MEGOHM 1% 1/2W	
A4R15	0757-0156	R:FXD MET FLM 1.5 MEGOHM 1% 1/2W	
A4R16	0698-3464	R:FXD MET FLM 1.47 MEGOHM 1% 1/2W	
A4R17	0757-0465	R:FXD MET FLM 100K OHM 1% 1/8W	
A4R18	0757-0313	R:FXD MET FLM 392K OHM 1% 1/2W	
A4R19	0687-1261	R:FXD COMP 12 MEGOHM 10% 1/2W	
A4R20	0757-0367	R:FXD MET FLM 100K OHM 1% 1/2W	
A4R21	0757-0313	R:FXD MET FLM 392K OHM 1% 1/2W	
A4R22	0757-0367	R:FXD MET FLM 100K OHM 1% 1/2W	
A4R23	0757-0313	R:FXD MET FLM 392K OHM 1% 1/2W	
A4R24	0757-0454	R:FXD MET FLM 33.2K OHM 1% 1/8W	
A4R25	0757-0857	R:FXD MET FLM 82.5K OHM 1% 1/2W	
A4R26	0757-0482	R:FXD MET FLM 511K OHM 1% 1/8W	
A4R27	0757-0059	R:FXD MET FLM 1 MEGOHM 1% 1/2W	
A4R28	0761-0032	R:FXD MET OX 56K OHM 5% 1W	
A4R29	0757-0444	R:FXD MET FLM 12.1K OHM 1% 1/8W	
A4R30	0761-0031	R:FXD MET OX 82K OHM 5% 1W	
A4R31	0757-0401	R:FXD MET FLM 100 OHM 1% 1/8W	
A4R32	2100-1759	R:VAR WW 2K OHM 5% 1W	
A4R33	0770-0009	R:FXD MET OX 47K OHM 5% 4W	
A4R34	0757-0442	R:FXD MET FLM 10.0K OHM 1% 1/8W	
A4V1	1932-0049	ELECTRON TUBE:CK647	

See introduction to this section for ordering information

Table 6-1. Reference Designation Index (Cont.)

Reference Designation	Part No.	Description #	Note
A4V2	1932-0067	ELECTRON TUBE: 12AY7	
A4V3	1932-0030	ELECTRON TUBE: 12AX7	
A4V4	1932-0049	ELECTRON TUBE: CK647	
A4V5	1923-0046	ELECTRON TUBE: 6EJ7 (EF 184) PENTODE	
A4V6	1923-0045	ELECTRON TUBE: 7239 PENTODE	
A5	08690-6033	BOARD ASSY: LOW VOLTAGE POWER SUPPLY	
A5C1	0150-0012	C: FXD CER 0.01 UF 20% 1000VDCW	
A5C2	0150-0012	C: FXD CER 0.01 UF 20% 1000VDCW	
A5C3	0150-0052	C: FXD CER 0.05 UF 20% 400VDCW	
A5C4	0150-0121	C: FXD CER 0.1UF +80%-20% 50VDCW	
A5C5	0150-0012	C: FXD CER 0.01 UF 20% 1000VDCW	
A5C6	0150-0012	C: FXD CER 0.01 UF 20% 1000VDCW	
A5C7	0160-2199	C: FXD MICA 30 PF 5%	
A5C8	0160-2218	C: FXD MICA 1000 PF 5%	
A5C9	0160-0174	C: FXD CER 0.47 UF +80-20% 25VDCW	
A5C10	0150-0052	C: FXD CER 0.05 UF 20% 400VDCW	
A5C11	0150-0052	C: FXD CER 0.05 UF 20% 400VDCW	
A5C12	0150-0052	C: FXD CER 0.05 UF 20% 400VDCW	
A5CR1	1902-0176	DIODE BREAKDOWN: 47.5V 1W	
A5CR2	1902-0176	DIODE BREAKDOWN: 47.5V 1W	
A5CR3	1902-0197	DIODE BREAKDOWN: SILICON 82.5V 5%	
A5CR4	1902-0025	DIODE, BREAKDOWN: 10.0V 5% 400 MW	
A5CR5	1901-0029	DIODE: SILICON 600 PIV	
A5CR6	1902-3369	DIODE BREAKDOWN: 61.9V 400MW	
A5CR7	1902-3369	DIODE BREAKDOWN: 61.9V 400MW	
A5CR8	1901-0033	DIODE: SILICON 100MA 180V	
A5CR9	1901-0033	DIODE: SILICON 100MA 180V	
A5CR10	1902-3428	DIODE BREAKDOWN: SILICON 100V 5%	
A5CR11	1901-0033	DIODE: SILICON 100MA 180V	
A5CR12	1902-3290	DIODE BREAKDOWN: SILICON 31.6V 5%	
A5CR13	1901-0033	DIODE: SILICON 100MA 180V	
A5CR14	1901-0033	DIODE: SILICON 100MA 180V	
A5CR15	1901-0033	DIODE: SILICON 100MA 180V	
A5CR16	1901-0029	DIODE: SILICON 600 PIV	
A5CR17	1902-0025	DIODE, BREAKDOWN: 10.0V 5% 400 MW	
A5CR18	1901-0029	DIODE: SILICON 600 PIV	
A5CR19	1901-0029	DIODE: SILICON 600 PIV	
A5CR20	1901-0029	DIODE: SILICON 600 PIV	
A5CR21	1901-0029	DIODE: SILICON 600 PIV	
A5CR22	1901-0029	DIODE: SILICON 600 PIV	
A5CR23	1901-0033	DIODE: SILICON 100MA 180V	
A5Q1	1854-0022	TRANSISTOR: NPN SILICON	
A5Q2	1854-0475	TRANSISTOR DUAL: SILICON NPN	

See introduction to this section for ordering information

Table 6-1. Reference Designation Index (Cont.)

Reference Designation	Part No.	Description #	Note
A5Q3	1854-0003	TRANSISTOR:NPN SILICON	
A5Q4	1854-0003	TRANSISTOR:NPN SILICON	
A5R1	0812-0018	R:FXD WW 100 OHM 3% 5W	
A5R2	0819-0027	R:FXD WW 10K OHM 5% 20W	
A5R3	0764-0031	R:FXD MET OX 47K OHM 5% 2W	
A5R4	0812-0018	R:FXD WW 100 OHM 3% 5W	
A5R5	0757-0856	R:FXD MET FLM 75.0K OHM 1% 1/2W	
A5R6	0757-0460	R:FXD MET FLM 61.9K OHM 1% 1/8W	
A5R7	2100-1760	R:VAR WW 5K OHM 10% LIN 1/2W	
A5R8	0757-0130	R:FXD MET FLM 162K OHM 1% 1/2W	
A5R9	0757-0280	R:FXD MET FLM 1K OHM 1% 1/8W	
A5R10	0698-3175	R:FXD MET FLM 147K OHM 1% 1/2W	
A5R11	0757-0458	R:FXD MET FLM 51.1K OHM 1% 1/8W	
A5R12	0757-0463	R:FXD MET FLM 82.5K OHM 1% 1/8W	
A5R13	0764-0031	R:FXD MET OX 47K OHM 5% 2W	
A5R14	0764-0031	R:FXD MET OX 47K OHM 5% 2W	
A5R15	0757-0133	R:FXD MET FLM 383K OHM 2% 1/2W	
A5R16	0757-0465	R:FXD MET FLM 100K OHM 1% 1/8W	
A5R17	0757-0063	R:FXD MET FLM 196K OHM 1% 1/2W	
A5R18	0698-3444	R:FXD MET FLM 316 OHM 1% 1/8W	
A5R19	0698-0085	R:FXD MET FLM 2.61K OHM 1% 1/8W	
A5R20	0757-0003	R:FXD MET FLM 26.1 OHM 1% 1/2W	
A5R21	0757-0394	R:FXD MET FLM 51.1 OHM 1% 1/8W	
A5R22	0757-0064	R:FXD MET FLM 261K OHM 1% 1/2W	
A5R23	0698-3425	R:FXD MET FLM 316K OHM 1% 1/2W	
A5R24	0757-0465	R:FXD MET FLM 100K OHM 1% 1/8W	
A5R25	0757-0442	R:FXD MET FLM 10.0K OHM 1% 1/8W	
A5R26	0757-0129	R:FXD MET FLM 178K OHM 2% 1/2W	
A5R27	2100-1760	R:VAR WW 5K OHM 10% LIN 1/2W	
A5R28	0757-0279	R:FXD MET FLM 3.16K OHM 1% 1/8W	
A5R29	0757-0367	R:FXD MET FLM 100K OHM 1% 1/2W	
A5R30	0757-0280	R:FXD MET FLM 1K OHM 1% 1/8W	
A5R31	0698-3437	R:FXD MET FLM 133 OHM 1% 1/8W	
A5R32	0698-3175	R:FXD MET FLM 147K OHM 1% 1/2W	
A5R33	0757-0424	R:FXD MET FLM 1.10K OHM 1% 1/8W	
A5R34	0757-0984	R:FXD MET FLM 10.0 OHM 1% 1/2W	
A5R35	0757-0130	R:FXD MET FLM 162K OHM 1% 1/2W	
A5R36	0698-3388	R:FXD MET FLM 14.7 OHM 1% 1/2W	
A5R37	0757-0394	R:FXD MET FLM 51.1 OHM 1% 1/8W	
A5V1	1932-0030	ELECTRON TUBE:12AX7	
A5V2	1940-0013	ELECTRON TUBE:82.0 +/- 1V	
A6	08690-6032	BOARD ASSY:REGULATOR	
A6C1	0150-0052	C:FXD CER 0.05 UF 20% 400VDCW	

See introduction to this section for ordering information

Table 6-1. Reference Designation Index (Cont.)

Reference Designation	Part No.	Description #	Note
A6C2	0150-0052	C:FXD CER 0.05 UF 20% 400VDCW	
A6CR1	1902-3381	DIODE BREAKDOWN:68.1V 400MW	
A6CR2	1902-3381	DIODE BREAKDOWN:68.1V 400MW	
A6CR3	1901-0029	DIODE:SILICON 600 PIV	
A6CR4	1902-0554	DIODE BREAKDOWN:10V 1W	
A6CR5	1901-0033	DIODE:SILICON 100MA 180WV	
A6CR6	1901-0033	DIODE:SILICON 100MA 180WV	
A6CR7	1902-3381	DIODE BREAKDOWN:68.1V 400MW	
A6CR8	1902-3381	DIODE BREAKDOWN:68.1V 400MW	
A6F1	2110-0004	FUSE:CARTRIDGE 1/4 AMP 250V	
A6F2	2110-0004	FUSE:CARTRIDGE 1/4 AMP 250V	
A6Q1	1854-0232	TRANSISTOR:SILICON NPN	
A6Q2	1854-0232	TRANSISTOR:SILICON NPN	
A6Q3	1854-0237	TRANSISTOR:SILICON NPN 2N3738	
A6Q4	1854-0237	TRANSISTOR:SILICON NPN 2N3738	
A6Q5	1854-0079	TRANSISTOR:SILICON 2N3439	
A6Q6	1854-0039	TRANSISTOR:SILICON 2N3053	
A6Q7	1854-0079	TRANSISTOR:SILICON 2N3439	
A6Q8	1854-0079	TRANSISTOR:SILICON 2N3439	
A6Q9	1854-0039	TRANSISTOR:SILICON 2N3053	
A6Q10	1854-0080	TRANSISTOR:SILICON	
A6Q11	1854-0080	TRANSISTOR:SILICON	
A6R1	0757-0856	R:FXD MET FLM 75.0K OHM 1% 1/2W	
A6R2	0757-0856	R:FXD MET FLM 75.0K OHM 1% 1/2W	
A6R3	0757-0401	R:FXD MET FLM 100 OHM 1% 1/8W	
A6R4	0757-0461	R:FXD MET FLM 68.1K OHM 1% 1/8W	
A6R5	0757-0280	R:FXD MET FLM 1K OHM 1% 1/8W	
A6R6	0811-0005	R:FXD WW 1500 OHM 1% 5W	
A6R7	0757-0856	R:FXD MET FLM 75.0K OHM 1% 1/2W	
A6R8	0757-0856	R:FXD MET FLM 75.0K OHM 1% 1/2W	
A6R9	0757-0401	R:FXD MET FLM 100 OHM 1% 1/8W	
A6R10	0757-0280	R:FXD MET FLM 1K OHM 1% 1/8W	
A6R11	0757-0401	R:FXD MET FLM 100 OHM 1% 1/8W	
A6R12	0757-0401	R:FXD MET FLM 100 OHM 1% 1/8W	
A6R13	0757-0280	R:FXD MET FLM 1K OHM 1% 1/8W	
A6R14	0757-0280	R:FXD MET FLM 1K OHM 1% 1/8W	
A6R15	0757-0279	R:FXD MET FLM 3.16K OHM 1% 1/8W	
A6R16	0757-0279	R:FXD MET FLM 3.16K OHM 1% 1/8W	

See introduction to this section for ordering information

Table 6-1. Reference Designation Index (Cont.)

Reference Designation	Part No.	Description #	Note
A7	08690-6016	BOARD ASSY:INTERCONNECTION	
	1251-0498	CONNECTOR:PC 22 CONTACTS	
A8	08690-6017	BOARD ASSY:HIGH VOLTAGE POWER SUPPLY	
A8C1	0150-0052	C:FXD CER 0.05 UF 20% 400VDCW	
A8C2	0180-0051	C:FXD ELECT 8 UF 350VDCW	
A8C3	0150-0052	C:FXD CER 0.05 UF 20% 400VDCW	
A8C4	0160-0907	C:FXD CER 0.01 UF +80-20% 5000VDCW	
A8C5	0160-0907	C:FXD CER 0.01 UF +80-20% 5000VDCW	
A8C6	0180-0104	C:FXD ELECT 200UF 15VDCW	
A8CR1	1901-0030	DIODE:SILICON 800 PIV	
A8CR2	1901-0084	DIODE ASSY:4000 PIV	
A8CR3	1901-0084	DIODE ASSY:4000 PIV	
A8Q1	1855-0001	TRANSISTOR:SILICON	
A8R1	0757-0198	R:FXD MET FLM 100 OHM 1% 1/2W	
A8R2	0816-0017	R:FXD WW 6300 OHM 10% 10W	
A8R3	0764-0028	R:FXD MET OX 100K OHM 5% 2W	
A8R4	0816-0004	R:FXD WW 800 OHM 10% 10W	
A8R5	0812-0037	R:FXD WW 20K OHM 3% 5W	
A8R6	0687-3311	R:FXD COMP 330 OHM 10% 1/2W	
A8R7	0687-3311	R:FXD COMP 330 OHM 10% 1/2W	
A8R8	0812-0037	R:FXD WW 20K OHM 3% 5W	
A8R9	0687-3311	R:FXD COMP 330 OHM 10% 1/2W	
A8R10	0836-0006	R:FXD CARBON 20 MEGOHM 10% 1W	
A8R11	0687-3311	R:FXD COMP 330 OHM 10% 1/2W	
A8R12	0693-1511	R:FXD COMP 150 OHM 10% 2W	
A8R13	0757-0475	R:FXD MET FLM 274K OHM 1% 1/8W FACTORY SELECTED PART	
A8R14	0757-0411	R:FXD MET FLM 332 OHM 1% 1/8W	
A8V1	1940-0007	ELECTRON TUBE:0B2	
A8V2	1923-0048	ELECTRON TUBE: 8068 BEAM PENTODE	
A8V3	1923-0048	ELECTRON TUBE: 8068 BEAM PENTODE	
A9	08690-6025	BOARD ASSY:RECTIFIER	
A9C1	0160-0168	C:FXD MY 0.1 UF 10% 200VDCW	
A9C2	0160-0168	C:FXD MY 0.1 UF 10% 200VDCW	
A9C3	0150-0012	C:FXD CER 0.01 UF 20% 1000VDCW	
A9C4	0160-0168	C:FXD MY 0.1 UF 10% 200VDCW	
A9C5	0150-0012	C:FXD CER 0.01 UF 20% 1000VDCW	
A9C6	0150-0052	C:FXD CER 0.05 UF 20% 400VDCW	
A9C7	0180-0063	C:FXD ELECT 500UF -10%+100% 3VDCW	
A9CR1 THRU A9CR8	1901-0200	DIODE:SILICON 100 PIV 3A	

See introduction to this section for ordering information

Table 6-1. Reference Designation Index (Cont.)

Reference Designation	Part No.	Description #	Note
A9CR9 THRU A9CR16	1901-0030 1901-0030	DIODE:SILICON 800 PIV DIODE:SILICON 800 PIV	
A9CR17	1902-0215	DIODE,BREAKDOWN:6.49V 5%	
A9K1		NOT ASSIGNED	
A9K2	0490-0716	RELAY:4PDT 6V	
A9R1 A9R2	0684-1001	R:FXD COMP 10 OHM 10% 1/4W NOT ASSIGNED	
A9R3 A9R4 A9R5 A9R6 A9R7	0684-1001 0684-1001 0687-1001 0687-3331 0687-1001	R:FXD COMP 10 OHM 10% 1/4W R:FXD COMP 10 OHM 10% 1/4W R:FXD COMP 10 OHM 10% 1/2W R:FXD COMP 33K OHM 10% 1/2W R:FXD COMP 10 OHM 10% 1/2W	
A9R8 A9R9 A9R10 A9R11 A9R12	0816-0015 0699-0001 0687-1051 0687-1051 0687-1031	R:FXD WW 50 OHM 10% 10W R:FXD COMP 2.7 OHM 10% 1/2W R:FXD COMP 1 MEGOHM 10% 1/2W R:FXD COMP 1 MEGOHM 10% 1/2W R:FXD COMP 10K OHM 10% 1/2W	
A9RT1 A10	0839-0006 08690-6019	THERMISTOR: 10 OHM 10% AT 25C BOARD ASSY:SWEEP GENERATOR	
A10C1	0150-0012	C:FXD CER 0.01 UF 20% 1000VDCW	
A10C2	0160-2222	C:FXD MICA 1500 PF 5% 300VDCW FACTORY SELECTED PART	
A10C3 A10C4 A10C5	0140-0161 0160-2225 0140-0192	C:FXD MICA 3932 PF 1% 300VDCW C:FXD MICA 2000 PF 5% 300VDCW C:FXD MICA 68 PF 5%	
A10CR1	1901-0033	DIODE:SILICON 100MA 180WV	
A10CR2 A10CR3 A10CR4 A10CR5 A10CR6	1901-0033 1901-0033 1901-0033 1901-0033 1901-0033	DIODE:SILICON 100MA 180WV DIODE:SILICON 100MA 180WV DIODE:SILICON 100MA 180WV DIODE:SILICON 100MA 180WV NOT ASSIGNED	
A10CR7	1901-0033	DIODE:SILICON 100MA 180WV	
A10Q1	1854-0003	TRANSISTOR:NPN SILICON	
A10Q2 A10Q3 A10Q4 A10Q5 A10Q6	1854-0003 1850-0062 1850-0062 1854-0003 1854-0003	TRANSISTOR:NPN SILICON TRANSISTOR:SPL2N404A TRANSISTOR:SPL2N404A TRANSISTOR:NPN SILICON TRANSISTOR:NPN SILICON	
A10Q7	1854-0003	TRANSISTOR:NPN SILICON	
A10R1	0686-1665	R:FXD COMP 16 MEGOHM 5% 1/2W	
A10R2 A10R3 A10R4 A10R5 A10R6	0757-0863 0698-5028 0698-4347 0698-5028 0698-4347	R:FXD MET FLM 243K OHM 1% 1/2W R:FXD MET FLM 2.87 MEGOHM 1% 1/4W R:FXD MET FLM 3.92 MEGOHM 1% 1/4W R:FXD MET FLM 2.87 MEGOHM 1% 1/4W R:FXD MET FLM 3.92 MEGOHM 1% 1/4W	
A10R7 A10R8 A10R9 A10R10	0698-4348 0698-4348 0757-0473 0757-0138	R:FXD MET FLM 4.99 MEGOHM 1% 1/4W R:FXD MET FLM 4.99 MEGOHM 1% 1/4W R:FXD MET FLM 221K OHM 1% 1/8W R:FXD MET FLM 909K OHM 2% 1/2W	

See introduction to this section for ordering information

Table 6-1. Reference Designation Index (Cont.)

Reference Designation	Part No.	Description #	Note
A10R11	0764-0031	R:FXD MET OX 47K OHM 5% 2W	
A10R12	0757-0481	R:FXD MET FLM 475K OHM 1% 1/8W	
A10R13	0698-4344	R:FXD MET FLM 1.82 MEGOHM 1% 1/4W	
A10R14	0757-0476	R:FXD MET FLM 301K OHM 1% 1/8W	
A10R15	0698-4345	R:FXD MET FLM 2 MEGOHM 1% 1/4W	
A10R16	0757-0461	R:FXD MET FLM 68.1K OHM 1% 1/8W	
A10R17	0757-0442	R:FXD MET FLM 10.0K OHM 1% 1/8W	
A10R18	0757-0442	R:FXD MET FLM 10.0K OHM 1% 1/8W	
A10R19	0757-0136	R:FXD MET FLM 619K OHM 1% 1/2W	
A10R20	0757-0437	R:FXD MET FLM 4750 OHM 1% 1/8WW	
A10R21	0757-0280	R:FXD MET FLM 1K OHM 1% 1/8W	
A10R22	0757-0401	R:FXD MET FLM 100 OHM 1% 1/8W	
A10R23	0757-0280	R:FXD MET FLM 1K OHM 1% 1/8W	
A10V1	1924-0001	ELECTRON TUBE:5915 PENTAGRID	
A11	08690-6020	BOARD ASSY:MARKER	
A11C1	0140-0178	C:FXD MICA 560 PF 2%	
A11C2	0140-0178	C:FXD MICA 560 PF 2%	
A11C3	0160-0798	C:FXD POLY 0.047 UF 10% 30VDCW	
A11C4	0160-0168	C:FXD MY 0.1 UF 10% 200VDCW	
A11C5	0160-0179	C:FXD MICA 33 PF 5% 300VDCW	
A11C6	0140-0200	C:FXD MICA 390 PF 5% ,FACTORY SELECTED PART	
A11C7	0140-0179	C:FXD MICA 1000 PF 2%	
A11CR1	1901-0033	DIODE:SILICON 100MA 180WV	
A11CR2	1901-0033	DIODE:SILICON 100MA 180WV	
A11CR3	1901-0033	DIODE:SILICON 100MA 180WV	
A11CR4	1901-0033	DIODE:SILICON 100MA 180WV	
A11CR5	1901-0033	DIODE:SILICON 100MA 180WV	
A11CR6	1901-0033	DIODE:SILICON 100MA 180WV	
A11CR7	1901-0033	DIODE:SILICON 100MA 180WV	
A11CR8	1901-0033	DIODE:SILICON 100MA 180WV	
A11CR9	1901-0033	DIODE:SILICON 100MA 180WV	
A11CR10	1901-0033	DIODE:SILICON 100MA 180WV	
A11CR11	1901-0033	DIODE:SILICON 100MA 180WV	
A11CR12	1901-0033	DIODE:SILICON 100MA 190WV	
A11CR13	1901-0033	DIODE:SILICON 100MA 180WV	
A11CR14	1901-0033	DIODE:SILICON 100MA 180WV	
A11CR15	1901-0033	DIODE:SILICON 100MA 180WV	
A11CR16	1903-0002	DIODE:SILICON 4-LAYER 20V	
A11CR17	1901-0033	DIODE:SILICON 100MA 180WV	
A11CR18	1901-0033	DIODE:SILICON 100MA 180WV	
A11Q1	1854-0003	TRANSISTOR:NPN SILICON	
A11Q2	1850-0062	TRANSISTOR:SPL2N404A	
A11Q3	1850-0062	TRANSISTOR:SPL2N404A	
A11Q4	1850-0062	TRANSISTOR:SPL2N404A	
A11Q5	1854-0003	TRANSISTOR:NPN SILICON	
A11Q6	1850-0062	TRANSISTOR:SPL2N404A	

See introduction to this section for ordering information

Table 6-1. Reference Designation Index (Cont.)

Reference Designation	Part No.	Description #	Note
A11Q7	1850-0062	TRANSISTOR:SPL2N404A	
A11Q8	1850-0062	TRANSISTOR:SPL2N404A	
A11Q9	1854-0003	TRANSISTOR:NPN SILICON	
A11Q10	1854-0003	TRANSISTOR:NPN SILICON	
A11Q11	1850-0062	TRANSISTOR:SPL2N404A	
A11Q12	1853-0001	TRANSISTOR:PNP SILICON 30V 900MH	
A11R1	0698-3154	R:FXD MET FLM 4.22K OHM 1% 1/8W,FACTORY SELECTED PART	
A11R2	2100-1472	R:VAR COMP 25K OHM 30% LIN 1/8W	
A11R3	0757-0128	R:FXD MET FLM 200K OHM 1% 1/2W	
A11R4	0757-0458	R:FXD MET FLM 51.1K OHM 1% 1/8W	
A11R5	0757-0442	R:FXD MET FLM 10.0K OHM 1% 1/8W	
A11R6	0757-0430	R:FXD MET FLM 2.21K OHM 1% 1/8W	
A11R7	0757-0199	R:FXD MET FLM 21.5K OHM 1% 1/8W	
A11R8	0757-0128	R:FXD MET FLM 200K OHM 1% 1/2W	
A11R9	0757-0442	R:FXD MET FLM 10.0K OHM 1% 1/8W	
A11R10	0757-0281	R:FXD MET FLM 2.74K OHM 1% 1/8W	
A11R11	0757-0442	R:FXD MET FLM 10.0K OHM 1% 1/8W	
A11R12	0757-0128	R:FXD MET FLM 200K OHM 1% 1/2W	
A11R13	0757-0124	R:FXD MET FLM 39.2K OHM 1% 1/8W	
A11R14	0757-0436	R:FXD MET FLM 4.32K OHM 1% 1/8W	
A11R15	0757-0440	R:FXD MET FLM 7.5K OHM 1% 1/8W	
A11R16	0757-0449	R:FXD MET FLM 20K OHM 1% 1/8W	
A11R17	0698-3154	R:FXD MET FLM 4.22K OHM 1% 1/8W,FACTORY SELECTED PART	
A11R18	2100-1472	R:VAR COMP 25K OHM 30% LIN 1/8W	
A11R19	0757-0128	R:FXD MET FLM 200K OHM 1% 1/2W	
A11R20	0757-0458	R:FXD MET FLM 51.1K OHM 1% 1/8W	
A11R21	0757-0442	R:FXD MET FLM 10.0K OHM 1% 1/8W	
A11R22	0757-0430	R:FXD MET FLM 2.21K OHM 1% 1/8W	
A11R23	0757-0199	R:FXD MET FLM 21.5K OHM 1% 1/8W	
A11R24	0757-0128	R:FXD MET FLM 200K OHM 1% 1/2W	
A11R25	0757-0442	R:FXD MET FLM 10.0K OHM 1% 1/8W	
A11R26	0757-0281	R:FXD MET FLM 2.74K OHM 1% 1/8W	
A11R27	0757-0442	R:FXD MET FLM 10.0K OHM 1% 1/8W	
A11R28	0757-0128	R:FXD MET FLM 200K OHM 1% 1/2W	
A11R29	0757-0124	R:FXD MET FLM 39.2K OHM 1% 1/8W	
A11R30	0757-0436	R:FXD MET FLM 4.32K OHM 1% 1/8W	
A11R31	0757-0440	R:FXD MET FLM 7.5K OHM 1% 1/8W	
A11R32	0757-0449	R:FXD MET FLM 20K OHM 1% 1/8W	
A11R33	0757-0438	R:FXD MET FLM 5.11K OHM 1% 1/8W	
A11R34	0757-0383	R:FXD MET FLM 18.2 OHM 1% 1/8W	
A11R35	0757-0465	R:FXD MET FLM 100K OHM 1% 1/8W	
A11R36	0757-0124	R:FXD MET FLM 39.2K OHM 1% 1/8W	
A11R37	0757-0438	R:FXD MET FLM 5.11K OHM 1% 1/8W	
A11R38	0757-0424	R:FXD MET FLM 1.10K OHM 1% 1/8W	
A11R39	0757-0438	R:FXD MET FLM 5.11K OHM 1% 1/8W	
A11R40	0757-0448	R:FXD MET FLM 18.2K OHM 1% 1/8W,FACTORY SELECTED PART	

See introduction to this section for ordering information

Table 6-1. Reference Designation Index (Cont.)

Reference Designation	Part No.	Description #	Note
A11R41	0757-0441	R:FXD MET FLM 8.25K OHM 1% 1/8W	
A11R42	0757-0444	R:FXD MET FLM 12.1K OHM 1% 1/8W	
A11R43	0757-0131	R:FXD MET FLM 274K OHM 1% 1W	
A11R44	0757-0433	R:FXD MET FLM 3.32K OHM 1% 1/8W	
A11R45	0757-0453	R:FXD MET FLM 30.1K OHM 1% 1/8W	
A11R46	0757-0446	R:FXD MET FLM 15K OHM 1% 1/8W	
A11R47	0757-0863	R:FXD MET FLM 243K OHM 1% 1/2W	
A11R48	0757-0481	R:FXD MET FLM 475K OHM 1% 1/8W	
A11R49	0757-0458	R:FXD MET FLM 51.1K OHM 1% 1/8W	
A12	08690-6028	BOARD ASSY:ALC AMPLIFIER	
A12C1	0140-0198	C:FXD MICA 200 PF 5%	
A12C2	0160-2224	C:FXD MICA 1800 PF 5%	
A12C3	0140-0198	C:FXD MICA 200 PF 5%	
A12CR1	1901-0033	DIODE:SILICON 100MA 180WV	
A12CR2	1901-0033	DIODE:SILICON 100MA 180WV	
A12Q1	1853-0020	TRANSISTOR:SILICON PNP	
A12Q2	1853-0020	TRANSISTOR:SILICON PNP	
A12Q3	1854-0071	TRANSISTOR:SILICON NPN	
A12Q4	1854-0475	TRANSISTOR DUAL:SILICON NPN	
A12R1	0757-0430	R:FXD MET FLM 2.21K OHM 1% 1/8W	
A12R2	0698-3157	R:FXD MET FLM 19.6K OHM 1% 1/8W	
A12R3	0757-0059	R:FXD MET FLM 1 MEGOHM 1% 1/2W	
A12R4	0757-0307	R:FXD MET FLM 332K OHM 1% 1/2W	
A12R5	0757-0437	R:FXD MET FLM 4750 OHM 1% 1/8WW	
A12R6	0698-3156	R:FXD MET FLM 14.7K OHM 1% 1/8W	
A12R7	2100-1760	R:VAR WW 5K OHM 10% LIN 1/2W	
A12R8	0698-3156	R:FXD MET FLM 14.7K OHM 1% 1/8W	
A12R9	0757-0415	R:FXD MET FLM 475 OHM 1% 1/8W	
A12R10	0757-0307	R:FXD MET FLM 332K OHM 1% 1/2W	
A12R11	0757-0415	R:FXD MET FLM 475 OHM 1% 1/8W	
A12R12	0687-1561	R:FXD COMP 15 MEGOHM 10% 1/2W	
A12R13	0757-0437	R:FXD MET FLM 4750 OHM 1% 1/8WW	
A12R14	0757-0307	R:FXD MET FLM 332K OHM 1% 1/2W	
A12R15	0757-0273	R:FXD MET FLM 3.01K OHM 1% 1/8W	
A12R16	0757-0059	R:FXD MET FLM 1 MEGOHM 1% 1/2W	
A12R17	0757-0280	R:FXD MET FLM 1K OHM 1% 1/8W	
A12R18	0757-0401	R:FXD MET FLM 100 OHM 1% 1/8W	
A12V1	1932-0030	ELECTRON TUBE:12AX7	
A13	08690-6023	BOARD ASSY:EXTENDER	
A14	08690-6022	BOARD ASSY:HEATER SUPPLY	

See introduction to this section for ordering information

Table 6-1. Reference Designation Index (Cont.)

Reference Designation	Part No.	Description #	Note
A14C1	0150-0012	C:FXD CER 0.01 UF 20% 1000VDCW	
A14C2	0180-0205	C:FXD ALUM. 12 UF -10 +75% 150VDCW	
A14C3	0150-0012	C:FXD CER 0.01 UF 20% 1000VDCW	
A14C4	0180-0155	C:FXD ELECT 2.2UF 20% 20VDCW	
A14C5	0180-0155	C:FXD ELECT 2.2UF 20% 20VDCW	
A14C6	0180-0058	C:FXD ELECT 50UF -10%+100% 25VDCW	
A14C7	0160-0166	C:FXD MY 6800PF 10%	
A14C8	0180-0155	C:FXD ELECT 2.2UF 20% 20VDCW	
A14C9	0180-0155	C:FXD ELECT 2.2UF 20% 20VDCW	
A14C10	0180-0098	C:FXD ELECT 100 UF 20% 20VDCW	
A14CR1	1902-0188	DIODE: BREAKDOWN 4.12V 5%	
A14CR2	1902-3182	DIODE BREAKDOWN: SILICON 12.1V 5%	
A14CR3	1902-0041	DIODE: BREAKDOWN 5.11V 5% 400MW	
A14Q1	1854-0071	TRANSISTOR: SILICON NPN	
A14Q2	1854-0039	TRANSISTOR: SILICON 2N3053	
A14Q3	1854-0039	TRANSISTOR: NPN SILICON	
A14Q4	1854-0039	TRANSISTOR: SILICON 2N3053	
A14Q5	1854-0003	TRANSISTOR: NPN SILICON	
A14Q6	1854-0003	TRANSISTOR: NPN SILICON	
A14Q7	1854-0071	TRANSISTOR: SILICON NPN	
A14Q8	1854-0003	TRANSISTOR: NPN SILICON	
A14R1	0757-0269	R:FXD MET FLM 270 OHM 1% 1/8W	
A14R2	0757-0280	R:FXD MET FLM 1K OHM 1% 1/8W	
A14R3	0757-0395	R:FXD MET FLM 56.2 OHM 1% 1/8W	
A14R4	0757-0461	R:FXD MET FLM 68.1K OHM 1% 1/8W	
A14R5	0757-0473	R:FXD MET FLM 221K OHM 1% 1/8W	
A14R6	0757-0401	R:FXD MET FLM 100 OHM 1% 1/8W	
A14R7	0757-0200	R:FXD MET FLM 5.62K OHM 1% 1/8W	
A14R8	0757-0352	R:FXD MET FLM 150K OHM 1% 1/2W	
A14R9	0757-0437	R:FXD MET FLM 4750 OHM 1% 1/8W	
A14R10	0757-0862	R:FXD MET FLM 221K OHM 1% 1/2W	
A14R11	0757-0442	R:FXD MET FLM 10.0K OHM 1% 1/8W	
A14R12	0757-0442	R:FXD MET FLM 10.0K OHM 1% 1/8W	
A14R13		NOT ASSIGNED	
A14R14	0757-0401	R:FXD MET FLM 100 OHM 1% 1/8W	
A14R15	0757-0421	R:FXD MET FLM 825 OHM 1% 1/8W	
A14R16	2100-1758	R:VAR WW 1K OHM 10% LIN 1/2W	
A14R17	0757-0200	R:FXD MET FLM 5.62K OHM 1% 1/8W	
A14R18	0764-0031	R:FXD MET OX 47K OHM 5% 2W	
A14R19	0757-0417	R:FXD MET FLM 562 OHM 1% 1/8W	
A14R20	0698-3440	R:FXD MET FLM 196 OHM 1% 1/8W	
A14R21	2100-1758	R:VAR WW 1K OHM 10% LIN 1/2W	
B1	3160-0056	FAN: TUBE AXIAL	
C1	0160-0983	C:FXD PAPER 2 UF 10% 2000VDCW	
C2	0160-0983	C:FXD PAPER 2 UF 10% 2000VDCW	
C3	0180-1829	C:FXD ELECT 3000 UF +50-10% 50VDCW	
C4	0180-1829	C:FXD ELECT 3000 UF +50-10% 50VDCW	
C5	0180-0213	C:FXD ELECT 5000 UF +75-10% 25VDCW	
C6	0150-0012	C:FXD CER 0.01 UF 20% 1000VDCW	

See introduction to this section for ordering information

Table 6-1. Reference Designation Index (Cont.)

Reference Designation	Part No.	Description #	Note
C7	0180-0030	C:FXD ELECT 40/120 UF 450VDCW	
C8	0180-0030	C:FXD ELECT 40/120 UF 450VDCW	
C9		NOT ASSIGNED	
C10	0150-0093	C:FXD CER 0.01 UF +80-20% 100VDCW	
C11	0150-0093	C:FXD CER 0.01 UF +80-20% 100VDCW	
CR1	1901-0028	DIODE:SILICON 400 PIV	
CR2		NOT ASSIGNED	
CR3-CR5	1901-0033	DIODE:SILICON 100MA 180WV	
DS1	2140-0293	LAMP:INCANDESCENT 6.3V	
DS2	2140-0293	LAMP:INCANDESCENT 6.3V	
DS3	2140-0293	LAMP:INCANDESCENT 6.3V	
DS4	2140-0293	LAMP:INCANDESCENT 6.3V	
DS5	2140-0293	LAMP:INCANDESCENT 6.3V	
DS6	2140-0293	LAMP:INCANDESCENT 6.3V	
DS7	2140-0293	LAMP:INCANDESCENT 6.3V	
DS8	2140-0092	LAMP:5V 60 MA	
DS9	2140-0092	LAMP:5V 60 MA	
F1	2110-0420	FUSE:CARTRIDGE .0312 AMP 250V NORM BLOW	
F2	2110-0002	FUSE:CARTRIDGE 2 AMP 250V	
F3	2110-0014	FUSE:CARTRIDGE 4 AMP 125V SLOW BLOW	
F4	2110-0035	FUSE:CARTRIDGE 8 AMP SLOW BLOW	
F5	2110-0002	FUSE:CARTRIDGE 2 AMP 3 AG	
J1	1250-0083	CONNECTOR:BNC	
J2	1250-0083	CONNECTOR:BNC	
J3	1250-0083	CONNECTOR:BNC	
J4	1250-0083	CONNECTOR:BNC	
J5	1250-0083	CONNECTOR:BNC	
J6	1251-2357	CONNECTOR:POWER 3 PIN MALE	
J7		CONNECTOR:INCLUDES	
J7	1510-0009	BINDING POST:BLACK	
J7	1510-0008	BINDING POST:RED	
J8		NOT ASSIGNED	
J9	1250-0083	CONNECTOR:BNC	
J10	1250-0083	CONNECTOR:BNC	
J11	1251-1323	CONNECTOR:RACK & PANEL 15 CONTACTS	
J12	1251-0137	RECEPTACLE:32 CONTACT	
K1		NOT ASSIGNED	
K2	0490-0115	RELAY:3PDT 6VDC	
K3	0490-0114	RELAY:SPDT 10K OHM 2300VDCW	
K4	0490-0123	RELAY:PENLIFT	
Q1	1854-0063	TRANSISTOR:NPN SILICON 2N3055	
Q2	1854-0063	TRANSISTOR:NPN SILICON 2N3055	
Q3	1854-0063	TRANSISTOR:NPN SILICON 2N3055	
Q4	1854-0063	TRANSISTOR:NPN SILICON 2N3055	
R1	2100-0043	R:VAR COMP 500K OHM 10% LIN 2W	
R2	2100-0753	R:VAR COMP 500K OHM 20% LIN 1/2W	
R3	0687-2231	R:FXD COMP 22K OHM 10% 1/2W	
R4	0757-0792	R:FXD MET FLM 681K OHM 1% 1/4W	
R5	0757-0465	R:FXD MET FLM 100K OHM 1% 1/8W	
R6	2100-0752	R:VAR WW 50K OHM 3% LIN 4W	
R7		NOT ASSIGNED	
R8	2100-0752	R:VAR WW 50K OHM 3% LIN 4W	

See introduction to this section for ordering information

Table 6-1. Reference Designation Index (Cont.)

Reference Designation	Part No.	Description #	Note
R9	2100-0752	R:VAR WW 50K OHM 3% LIN 4W	
R10	2100-0752	R:VAR WW 50K OHM 3% LIN 4W	
R11	2100-0968	R:VAR COMP 10K OHM 30% 20CCLOG 1/4W	
R12	2100-0073	R:VAR COMP 125K OHM 20% LIN 1/4W	
R13-		NOT ASSIGNED	
R15		NOT ASSIGNED	
R16	0812-0019	R:FXD WW 0.33 OHM 5% 3W	
R17	0812-0019	R:FXD WW 0.33 OHM 5% 3W	
R18	0698-3430	R:FXD MET FLM 21.5 OHM 1% 1/8W	
R19-		NOT ASSIGNED	
R22		NOT ASSIGNED	
R23	0684-1011	R:FXD COMP 100 OHM 10% 1/4W	
R24	0686-1035	R:FXD COMP 10K OHM 5% 1/2W	
R25	0686-1035	R:FXD COMP 10K OHM 5% 1/2W	
S1		NOT ASSIGNED	
S2	3101-0052	SWITCH:PUSHBUTTON SPST	
S3	3101-0922	SWITCH:PUSHBUTTON	
S4	3101-1153	SWITCH:PUSHBUTTON	
S5	3101-1153	SWITCH:PUSHBUTTON	
S6	3101-1153	SWITCH:PUSHBUTTON	
S7	3101-1153	SWITCH:PUSHBUTTON	
S8	3101-1153	SWITCH:PUSHBUTTON	
S9	3100-2622	SWITCH:ROTARY	
S10	3100-1501	SWITCH:ROTARY	
S11	3101-0041	SWITCH:TOGGLE DPST	
S12		NOT ASSIGNED	
S13	3101-0011	SWITCH:SLIDE DPDT	
S14	3101-0034	SWITCH:SLIDE 4PDT	
T1	9100-3111	TRANSFORMER:POWER	
T2	9100-1748	TRANSFORMER:LOW VOLTAGE	
W1	8120-1348	CABLE ASSY:POWER CORD	
XF1	1400-0084	FUSEHOLDER:EXTRACTOR POST TYPE	
XF2	1400-0084	FUSEHOLDER:EXTRACTOR POST TYPE	
XF3	0510-0744	FUSEHOLDER:2 POLE FOR 1/4" DIA	
XF4	0510-0744	FUSEHOLDER:2 POLE FOR 1/4" DIA	
		MISCELLANEOUS	
	0370-0050	HANDLE:CRANK ONLY 3/8 IN. OD	
	0370-0084	KNOB:RND BLACK 5/8" DIA	
	0370-0099	KNOB:SKIRTED BAR 5/8" DIA	
	0370-0104	KNOB:BLACK BAR W/ARROW 13/16 DIA 1/4" SHAFT	
	0370-0118	KNOB:GRAY PUSHBUTTON 11/16 IN DIA	
	0370-0134	KNOB:ROUND,RED 1/2" DIA	
	0370-0331	KNOB:BLACK 1" OD	
	1220-0010	SHIELD:TUBE	
	1220-0049	SHIELD:TUBE	
	1251-0233	CONNECTOR:PC 44 CONTACTS	
	1251-1115	KEY:POLARIZING FOR CKT BD SOCKETS	

See introduction to this section for ordering information

Table 6-1. Reference Designation Index (Cont.)

Reference Designation	Part No.	Description #	Note
	1400-0084	FUSEHOLDER:EXTRACTOR POST TYPE	
	1400-0116	CLAMP:CABLE 3/16" DIA	
	1401-0007	CLIP:TUBE 1/4"	
	1410-0033	BUSHING:KNOB BRASS	
	1410-0112	BUSHING:5/16-32 THD	
	1450-0373	LAMPHOLDER ASSY(MODE INDICATOR)	
	1450-0157	LENS:LAMPHOLDER WHITE PLASTIC	
	1450-0153	LAMPHOLDER:FOR T-1 SERIES	
	1600-0118	SPACER:CAM	
	00693-022	SUPPORT:TUBE	
	00693-205	COUPLER:PDT	
	1450-0371	LENS:LAMPHOLDER, AMBER	
	08690-0012	CLAMP:CAPACITOR	
	08690-0016	COVER ASSY:TOP	
	08690-0017	COVER ASSY:BOTTOM	
	08690-0018	BRACKET:FUSEHOLDER	
	08690-0020	RF UNIT GROUNDING	
	08690-0106	SPRING	
	08690-0022	PLATE:CONNECTOR	
	08690-2002	CAM	
	08690-2003	PLATE:DETENT	
	08690-2004	SUPPORT:CAPACITOR CLAMP	
	08690-2005	SUPPORT:REG. BOARD	
	08690-2006	WINDOW:PROTECTIVE	
	08690-2035	PIN:RF UNIT GUIDE	
	08690-2037	RAIL:UPPER GUIDE	
	08690-2038	RAIL:LOWER GUIDE	
	08690-4105	GLIDE:CORNER(LIGHT GRAY)	
	08690-40002	GLIDE:CORNER(MINT GRAY)	
	08690-6041	PANEL ASSY:FRONT	
	08690-6042	DRIVE ASSY:DIAL	
	08690-2041	TRIM TOP(LIGHT GRAY)	
	08690-2042	EXTRUSION	
	3130-0321	SHIELD:ROTARY SWITCH	

See introduction to this section for ordering information

Table 6-1. Reference Designation Index (Cont.)

Reference Designation	Part No.	Description #	Note
	08690-0016	COVER ASSY:TOP	
	08690-00031	PANEL:REAR(LIGHT GRAY)	
	5000-0746	SIDE COVER	
	08690-0017	COVER ASSY:BOTTOM	
	5060-0777	KIT:RACK MOUNT	
	5060-0736	FRAME ASSY	
	5060-0222	HANDLE ASSY-SIDE	
	5060-0765	RETAINER-HANDLE ASSY.	
	5060-0767	FOOT ASSY:FM	
	1490-0030	STAND:TILT	
	5000-0053	PLATE:FLUTED ALUMINUM	
	08690-6005	PANEL:FRONT	
	08690-00033	COVER ASSY:TOP(COLIVE GRAY)	
	08690-00034	COVER ASSY:BOTTOM(COLIVE GRAY)	
	08690-00035	PANEL:REAR(MINT GRAY)	
	08690-90013	8690B/RF UNIT OVERALL SCHEMATIC	

See introduction to this section for ordering information

Table 6-2. Replaceable Parts

Part No.	Description #	Mfr.	Mfr. Part No.	TQ	RS
0140-0145	C:FXD MICA 22 PF 5%	28480	0140-0145	2	
0140-0161	C:FXD MICA 3932 PF 1% 300VDCW	28480	0140-0161	1	
0140-0178	C:FXD MICA 560 PF 2%	72136	RDM15F561G3C	2	
0140-0179	C:FXD MICA 1000 PF 2%	28480	0140-0179	1	
0140-0192	C:FXD MICA 68 PF 5%	28480	0140-0192	1	
0140-0193	C:FXD MICA 82 PF 5%	28480	0140-0193	2	
0140-0195	C:FXD MICA 130 PF 5% 300 VDCW	04062	DM15F131J 300V	1	
0140-0198	C:FXD MICA 200 PF 5%	28480	0140-0198	2	
0140-0200	C:FXD MICA 390 PF 5%	28480	0140-0200	1	
0140-0216	C:FXD MICA 120 PF 2%	28480	0140-0216	1	
0140-0201	C:FXD MICA 12PF 5%	28480	0140-0201	1	
0150-0012	C:FXD CER 0.01 UF 20% 1000VDCW	56289	29C214A3	12	
0150-0052	C:FXD CER 0.05 UF 20% 400VDCW	56289	33C17A	12	
0150-0093	C:FXD CER 0.01 UF +80-20% 100VDCW	91418	TA	2	
0150-0121	C:FXD CER 0.1UF +80%-20% 50VDCW	56289	5C50A	1	
0160-0158	C:FXD MYLAR 5600PF 10%	28480	0160-0158	1	
0160-0166	C:FXD MY 6800PF 10%	28480	0160-0166	1	
0160-0168	C:FXD MY 0.1 UF 10% 200VDCW	28480	0160-0168	4	
0160-0174	C:FXD CER 0.47 UF +80-20% 25VDCW	56289	5C11B7	1	
0160-0179	C:FXD MICA 33 PF 5% 300VDCW	04062	DM15E330J 300V	1	
0160-0381	C:FXD MY 0.01 UF 10% 400VDCW	84411	663UW	1	
0160-0382	C:FXD MY 0.001 UF 10% 400VDCW	84411	663UW	1	
0160-0798	C:FXD POLY 0.047 UF 10% 30VDCW	56289	114P4739R3S4-PYP	1	
0160-0907	C:FXD CER 0.01 UF +80-20% 5000VDCW	14655	TM50R123Z-1	2	
0160-0983	C:FXD PAPER 2 UF 10% 2000VDCW	03508	23F1246	2	
0160-2150	C:FXD MICA 33 PF 5%	28480	0160-2150	1	
0160-2120	C:FXD MICA 0.01 UF 1%	04062	RDM30F103F3C	1	
0160-2199	C:FXD MICA 30 PF 5%	28480	0160-2199	1	
0160-2217	C:FXD MICA 910 PF 5%	28480	0160-2217	1	
0160-2218	C:FXD MICA 1000 PF 5%	28480	0160-2218	3	
0160-2222	C:FXD MICA 1500 PF 5% 300VDCW	28480	0160-2222	1	
0160-2224	C:FXD MICA 1800 PF 5%	28480	0160-2224	1	
0160-2675	C:FXD MICA 8900 PF 1% 300VDCW	28480	0160-2675	1	
0160-2225	C:FXD MICA 2000 PF 5% 300VDCW	28480	0160-2225	2	
0170-0022	C:FXD MY 0.1UF 20% 600VDCW	09134	TYPE 24	1	
0170-0055	C:FXD MY 0.1UF 20% 200VDCW	56289	192P10402	1	
0170-0073	C:FXD MY 1UF 10% 600VDCW	09134	1041	1	
0180-0030	C:FXD ELECT 40/120 UF 450VDCW	56289	D32352 DFP	2	
0180-0051	C:FXD ELECT 8 UF 350VDCW	56289	D32551	2	
0180-0058	C:FXD ELECT 50UF -10%+100% 25VDCW	56289	30D506G025DD4M1	1	
0180-0063	C:FXD ELECT 500UF -10%+100% 3VDCW	56289	30D507G003DH6M1	1	
0180-0089	C:FXD ELECT 10UF-10%+100% 150VDCW	56289	30D106G150DF4	1	
0180-0098	C:FXD ELECT 100 UF 20% 20VDCW	28480	0180-0098	1	
0180-0104	C:FXD ELECT 200UF 15VDCW	56289	30D207G015DH4	1	
0180-0155	C:FXD ELECT 2.2UF 20% 20VDCW	56289	150D225X0020A2	4	
0180-0197	C:FXD ELECT 2.2 UF 10% 20VDCW	56289	150D225X9020A2	1	
0180-0205	C:FXD ALUM. 12 UF -10 +75% 150VDCW	05571	30D126G150DH4	1	
0180-0213	C:FXD ELECT 5000 UF +75-10% 25VDCW	56289	D39556	1	
0180-0269	C:FXD ELECT 1.0 UF +50-10% 150VDCW	56289	30D105F150BA2-DSM	1	
0180-1829	C:FXD ELECT 3000 UF +50-10% 50VDCW	56289	D43845-DPA	2	
0370-0050	HANDLE:CRANK ONLY 3/8 IN. OD	28480	0270-0050	4	
0370-0099	KNOB:SKIRTED BAR 5/8 DIA	28480	0370-0099	1	
0370-0104	KNOB:BLACK BAR W/ARROW 13/16 DIA 1/4 SH	28480	20370-0104	1	
0370-0118	KNOB:GRAY PUSHBUTTON 11/16 IN DIA	28480	0370-0118	9	
0370-0134	KNOB:ROUND,RED 1/2 DIA	28480	0370-0134	1	
0370-0331	KNOB:BLACK 1 OD	28480	0370-0331	4	
0490-0114	RELAY:SPDT LOK OHM 2300VDCW	77342	KA 2577-1	1	

See introduction to this section for ordering information

Table 6-2. Replaceable Parts (Cont.)

Part No.	Description #	Mfr.	Mfr. Part No.	TQ	RS
0490-0115	RELAY:3PDT 6VDC	77342	KA14DY	1	
0490-0123	RELAY	28480	0490-0123	1	
0490-0323	RELAY:4PDT	28480	0490-0323	1	
0490-0716	RELAY:4PDT 6V	70309	T255-CC-CC	1	
0510-0744	FUSEHOLDER:2 POLE FOR 1/4" DIA	75915	350277	2	
0684-1001	R:FXD COMP 10 OHM 10% 1/4W	01121	CB 1001	3	
0684-1011	R:FXD COMP 100 OHM 10% 1/4W	01121	CB 1011	1	
0686-1035	R:FXD COMP 10K OHM 5% 1/2W	01121	EB 1035	2	
0686-1665	R:FXD COMP 16 MEGOHM 5% 1/2W	01121	EB 1665	1	
0686-3055	R:FXD COMP 3 MEGOHM 5% 1/2W	01121	EB 3055	1	
0687-1001	R:FXD COMP 10 OHM 10% 1/2W	01121	EB 1001	2	
0687-1031	R:FXD COMP 10K OHM 10% 1/2W	01121	EB 1031	1	
0687-1051	R:FXD COMP 1 MEGOHM 10% 1/2W	01121	EB 1051	2	
0687-1261	R:FXD COMP 12 MEGOHM 10% 1/2W	01121	EB 1261	2	
0687-1561	R:FXD COMP 15 MEGOHM 10% 1/2W	01121	EB 1561	1	
0687-2231	R:FXD COMP 22K OHM 10% 1/2W	01121	EB 2231	1	
0687-3311	R:FXD COMP 330 OHM 10% 1/2W	01121	EB 3311	4	
0687-3331	R:FXD COMP 33K OHM 10% 1/2W	01121	EB 3331	1	
0687-4751	R:FXD COMP 4.7 MEGOHM 10% 1/2W	01121	EB 4751	1	
0687-8241	R:FXD COMP 820K OHM 10% 1/2W	01121	EB 8241	1	
0693-1511	R:FXD COMP 150 OHM 10% 2W	01121	HB 1511	1	
0698-0063	R:FXD MET FLM 5.23K OHM 1% 1/8W	28480	0698-0063	2	
0698-0085	R:FXD MET FLM 2.61K OHM 1% 1/8W	28480	0698-0085	1	
0698-3155	R:FXD MET FLM 4.64K OHM 1% 1/8W	28480	0698-3155	1	
0698-3156	R:FXD MET FLM 14.7K OHM 1% 1/8W	28480	0698-3156	2	
0698-3157	R:FXD MET FLM 19.6K OHM 1% 1/8W	28480	0698-3157	1	
0698-3160	R:FXD MET FLM 31.6K OHM 1% 1/8W	28480	0698-3160	1	
0698-3175	R:FXD MET FLM 147K OHM 1% 1/2W	28480	0698-3175	3	
0698-3388	R:FXD MET FLM 14.7 OHM 1% 1/2W	28480	0698-3388	1	
0698-3424	R:FXD MET FLM 237K OHM 1% 1/2W	28480	0698-3424	1	
0698-3425	R:FXD MET FLM 316K OHM 1% 1/2W	28480	0698-3425	2	
0698-3430	R:FXD MET FLM 21.5 OHM 1% 1/8W	28480	0698-3430	2	
0698-3437	R:FXD MET FLM 133 OHM 1% 1/8W	28480	0698-3437	1	
0698-3440	R:FXD MET FLM 196 OHM 1% 1/8W	28480	0698-3440	1	
0698-3444	R:FXD MET FLM 316 OHM 1% 1/8W	28480	0698-3444	3	
0698-3451	R:FXD MET FLM 133K OHM 1% 1/8W	28480	0698-3451	3	
0698-3453	R:FXD MET FLM 196K OHM 1% 1/8W	28480	0698-3453	1	
0698-3464	R:FXD MET FLM 1.47 MEGOHM 1% 1/2W	28480	0698-3464	2	
0698-3592	R:FXD MET FLM 10.0 MEGOHM 1% 1/2W	28480	0698-3592	1	
0698-3647	R:FXD MET OX 15K OHM 5% 2W	28480	0698-3647	1	
0698-4344	R:FXD MET FLM 1.82 MEGOHM 1% 1/4W	28480	0698-4344	1	
0698-4345	R:FXD MET FLM 2 MEGOHM 1% 1/4W	28480	0698-4345	1	
0698-4347	R:FXD MET FLM 3.92 MEGOHM 1% 1/4W	28480	0698-4347	2	
0698-4348	R:FXD MET FLM 4.99 MEGOHM 1% 1/4W	28480	0698-4348	2	
0698-5028	R:FXD MET FLM 2.87 MEGOHM 1% 1/4W	28480	0698-5028	2	
0699-0001	R:FXD COMP 2.7 OHM 10% 1/2W	01121	EB 27G1	1	
0727-0292	R:FXD CARBON 3 MEGOHM 1% 1/2W	28480	0727-0292	2	
0757-0003	R:FXD MET FLM 26.1 OHM 1% 1/2W	28480	0757-0003	1	
0757-0017	R:FXD MET FLM 247.5 OHM 1% 1/4W	28480	0757-0017	2	
0757-0059	R:FXD MET FLM 1 MEGOHM 1% 1/2W	28480	0757-0059	2	
0757-0063	R:FXD MET FLM 196K OHM 1% 1/2W	28480	0757-0063	1	
0757-0064	R:FXD MET FLM 261K OHM 1% 1/2W	28480	0757-0064	1	
0757-0124	R:FXD MET FLM 39.2K OHM 1% 1/8W	28480	0757-0124	3	
0757-0128	R:FXD MET FLM 200K OHM 1% 1/2W	28480	0757-0128	6	

See introduction to this section for ordering information

Table 6-2. Replaceable Parts (Cont.)

Part No.	Description #	Mfr.	Mfr. Part No.	TQ	RS
0757-0129	R:FXD MET FLM 178K OHM 2% 1/2W	28480	0757-0129	1	
0757-0130	R:FXD MET FLM 162K OHM 1% 1/2W	28480	0757-0130	2	
0757-0131	R:FXD MET FLM 274K OHM 1% 1W	28480	0757-0131	1	
0757-0133	R:FXD MET FLM 383K OHM 2% 1/2W	28480	0757-0133	1	
0757-0135	R:FXD MET FLM 511K OHM 1% 1/2W	28480	0757-0135	3	
0757-0136	R:FXD MET FLM 619K OHM 1% 1/2W	28480	0757-0136	3	
0757-0138	R:FXD MET FLM 909K OHM 2% 1/2W	28480	0757-0138	1	
0757-0156	R:FXD MET FLM 1.5 MEGOHM 1% 1/2W	28480	0757-0156	2	
0757-0198	R:FXD MET FLM 100 OHM 1% 1/2W	28480	0757-0198	1	
0757-0199	R:FXD MET FLM 21.5K OHM 1% 1/8W	28480	0757-0199	2	
0757-0200	R:FXD MET FLM 5.62K OHM 1% 1/8W	28480	0757-0200	2	
0757-0269	R:FXD MET FLM 270 OHM 1% 1/8W	28480	0757-0269	1	
0757-0273	R:FXD MET FLM 3.01K OHM 1% 1/8W	28480	0757-0273	1	
0757-0279	R:FXD MET FLM 3.16K OHM 1% 1/8W	28480	0757-0279	4	
0757-0280	R:FXD MET FLM 1K OHM 1% 1/8W	28480	0757-0280	15	
0757-0281	R:FXD MET FLM 2.74K OHM 1% 1/8W	28480	0757-0281	2	
0757-0289	R:FXD MET FLM 13.3K OHM 1% 1/8W	28480	0757-0289	1	
0757-0307	R:FXD MET FLM 332K OHM 1% 1/2W	28480	0757-0307	5	
0757-0313	R:FXD MET FLM 392K OHM 1% 1/2W	28480	0757-0313	4	
0757-0352	R:FXD MET FLM 150K OHM 1% 1/2W	28480	0757-0352	2	
0757-0367	R:FXD MET FLM 100K OHM 1% 1/2W	28480	0757-0367	4	
0757-0374	R:FXD MET FLM 485K OHM 1% 1/2W	28480	0757-0374	2	
0757-0383	R:FXD MET FLM 18.2 OHM 1% 1/8W	28480	0757-0383	1	
0757-0394	R:FXD MET FLM 51.1 OHM 1% 1/8W	28480	0757-0394	2	
0757-0395	R:FXD MET FLM 56.2 OHM 1% 1/8W	28480	0757-0395	1	
0757-0401	R:FXD MET FLM 100 OHM 1% 1/8W	28480	0757-0401	9	
0757-0411	R:FXD MET FLM 332 OHM 1% 1/8W	28480	0757-0411	1	
0757-0415	R:FXD MET FLM 475 OHM 1% 1/8W	28480	0757-0415	5	
0757-0417	R:FXD MET FLM 562 OHM 1% 1/8W	28480	0757-0417	1	
0757-0421	R:FXD MET FLM 825 OHM 1% 1/8W	28480	0757-0421	1	
0757-0424	R:FXD MET FLM 1.10K OHM 1% 1/8W	28480	0757-0424	2	
0757-0428	R:FXD MET FLM 1.62K OHM 1% 1/8W	28480	0757-0428	1	
0757-0430	R:FXD MET FLM 2.21K OHM 1% 1/8W	28480	0757-0430	3	
0757-0431	R:FXD MET FLM 2.43K OHM 1% 1/8W	28480	0757-0431	1	
0757-0433	R:FXD MET FLM 3.32K OHM 1% 1/8W	28480	0757-0433	1	
0757-0436	R:FXD MET FLM 4.32K OHM 1% 1/8W	28480	0757-0436	2	
0757-0437	R:FXD MET FLM 4750 OHM 1% 1/8W	28480	0757-0437	4	
0757-0438	R:FXD MET FLM 5.11K OHM 1% 1/8W	28480	0757-0438	3	
0757-0440	R:FXD MET FLM 7.5K OHM 1% 1/8W	28480	0757-0440	2	
0757-0441	R:FXD MET FLM 8.25K OHM 1% 1/8W	28480	0757-0441	1	
0757-0442	R:FXD MET FLM 10.0K OHM 1% 1/8W	28480	0757-0442	15	
0757-0444	R:FXD MET FLM 12.1K OHM 1% 1/8W	28480	0757-0444	2	
0757-0446	R:FXD MET FLM 15K OHM 1% 1/8W	28480	0757-0446	3	
0757-0448	R:FXD MET FLM 18.2K OHM 1% 1/8W	28480	0757-0448	1	
0757-0449	R:FXD MET FLM 20K OHM 1% 1/8W	28480	0757-0449	2	
0757-0453	R:FXD MET FLM 30.1K OHM 1% 1/8W	28480	0757-0453	1	
0757-0454	R:FXD MET FLM 33.2K OHM 1% 1/8W	28480	0757-0454	1	
0757-0457	R:FXD MET FLM 47.5K OHM 1% 1/8W	28480	0757-0457	2	
0757-0458	R:FXD MET FLM 51.1K OHM 1% 1/8W	28480	0757-0458	5	
0757-0459	R:FXD MET FLM 56.2K OHM 1% 1/8W	28480	0757-0459	1	
0757-0460	R:FXD MET FLM 61.9K OHM 1% 1/8W	28480	0757-0460	1	
0757-0461	R:FXD MET FLM 68.1K OHM 1% 1/8W	28480	0757-0461	5	
0757-0463	R:FXD MET FLM 82.5K OHM 1% 1/8W	28480	0757-0463	1	
0757-0465	R:FXD MET FLM 100K OHM 1% 1/8W	28480	0757-0465	7	

See introduction to this section for ordering information

Table 6-2. Replaceable Parts (Cont.)

Part No.	Description #	Mfr.	Mfr. Part No.	TQ	RS
0757-0467	R:FXD MET FLM 121K OHM 1% 1/8W	28480	0757-0467	1	
0757-0473	R:FXD MET FLM 221K OHM 1% 1/8W	28480	0757-0473	2	
0757-0474	R:FXD MET FLM 243K OHM 1% 1/8W	28480	0757-0474	2	
0757-0475	R:FXD MET FLM 274K OHM 1% 1/8W	28480	0757-0475	1	
0757-0476	R:FXD MET FLM 301K OHM 1% 1/8W	28480	0757-0476	1	
0757-0481	R:FXD MET FLM 475K OHM 1% 1/8W	28480	0757-0481	2	
0757-0482	R:FXD MET FLM 511K OHM 1% 1/8W	28480	0757-0482	2	
0757-0792	R:FXD MET FLM 681K OHM 1% 1/4W	28480	0757-0792	1	
0757-0839	R:FXD MET FLM 10K OHM 1% 1/2W	28480	0757-0839	2	
0757-0856	R:FXD MET FLM 75.0K OHM 1% 1/2W	28480	0757-0856	6	
0757-0857	R:FXD MET FLM 82.5K OHM 1% 1/2W	28480	0757-0857	1	
0757-0860	R:FXD MET FLM 121K OHM 1% 1/2W	28480	0757-0860	1	
0757-0862	R:FXD MET FLM 221K OHM 1% 1/2W	28480	0757-0862	2	
0757-0863	R:FXD MET FLM 243K OHM 1% 1/2W	28480	0757-0863	2	
0757-0984	R:FXD MET FLM 10.0 OHM 1% 1/2W	28480	0757-0984	1	
0757-1094	R:FXD MET FLM 1.47K OHM 1% 1/8W	28480	0757-1094	3	
0761-0031	R:FXD MET OX 82K OHM 5% 1W	28480	0761-0031	1	
0761-0032	R:FXD MET OX 56K OHM 5% 1W	28480	0761-0032	1	
0761-0033	R:FXD MET OX 220K OHM 5% 1W	28480	0761-0033	3	
0761-0040	R:FXD MET OX 150K OHM 5% 1W	28480	0761-0040	1	
0764-0028	R:FXD MET OX 100K OHM 5% 2W	28480	0764-0028	2	
0764-0031	R:FXD MET OX 47K OHM 5% 2W	28480	0764-0031	6	
0764-0047	R:FXD MET OX 82K OHM 5% 2W	28480	0764-0047	1	
0770-0009	R:FXD MET OX 47K OHM 5% 4W	28480	0770-0009	1	
0811-0005	R:FXD WW 1500 OHM 1% 5W	28480	0811-0005	1	
0812-0018	R:FXD WW 100 OHM 3% 5W	28480	0812-0018	2	
0812-0019	R:FXD WW 0.33 OHM 5% 3W	28480	0812-0019	2	
0812-0037	R:FXD WW 20K OHM 3% 5W	28480	0812-0037	2	
0812-0053	R:FXD WW 500K OHM 1% 1/4W	28480	0812-0053	4	
0816-0004	R:FXD WW 800 OHM 10% 10W	28480	0816-0004	1	
0816-0015	R:FXD WW 50 OHM 10% 10W	28480	0816-0015	1	
0816-0017	R:FXD WW 6300 OHM 10% 10W	28480	0816-0017	1	
0819-0027	R:FXD WW 10K OHM 5% 20W	28480	0819-0027	1	
0836-0006	R:FXD CARBON 20 MEGOHM 10% 1W	28480	0836-0006	1	
0839-0006	THERMISTOR: 10 OHM 10% AT 25C	24446	2D-754	1	
1200-0049	SOCKET:TUBE 7 PIN MINIATURE	71785	111-51-11-096	1	
1200-0062	SOCKET:TUBE 9 PIN MIN.	71785	121-51-11-060	1	
1220-0010	SHIELD:TUBE	71785	150-11-23-012	1	
1220-0049	SHIELD:TUBE	71785	TR6 6020B	5	
1250-0083	CONNECTOR:BNC	28480	1250-0083	7	
1251-0137	RECEPTACLE:32 CONTACT	02660	26-4200-32S	1	
1251-0148	CONNECTOR:POWER 3 PIN MALE	87930	1065-1	1	
1251-0233	CONNECTOR:PC 44 CONTACTS	28480	1251-0233	1	
1251-0498	CONNECTOR:PC 22 CONTACTS	28480	1251-0498	7	
1251-1115	KEY:POLARIZING FOR CKT BD SOCKETS	71785	456-99-99-193	8	
1251-1323	CONNECTOR:RACK & PANEL 15 CONTACTS	81312	SA155	1	
1400-0084	FUSEHOLDER:EXTRACTOR POST TYPE	79515	342014	4	
1400-0116	CLAMP:CABLE 3/16" DIA	28480	1400-0116	5	
1401-0007	CLIP:TUBE 1/4"	76487	36004	1	
1410-0033	BUSHING:KNOB BRASS	28480	1410-0033	4	
1410-0112	BUSHING:5/16-32 THD	28480	1410-0112	1	
1450-0152	LEN:LAMPHOLDER RED PLASTIC	08717	102XX-R	2	
1450-0153	LAMPHOLDER:FOR T-1 SERIES	08717	102SR	2	
1450-0373	LAMPHOLDER ASSY(MODE INDICATOR)	28480	1450-0373	1	
1490-0030	STAND:TILT	28480	1490-0030	1	

See introduction to this section for ordering information

Table 6-2. Replaceable Parts (Cont.)

Part No.	Description #	Mfr.	Mfr. Part No.	TQ	RS
1510-0008	BINDING POST:RED	28480	1510-0008	1	
1510-0009	BINDING POST:BLACK	28480	1510-0009	1	
1600-0118	SPACER:CAM	28480	1600-0118	2	
1850-0062	TRANSISTOR:SPL2N404A	28480	1850-0062	9	
1853-0001	TRANSISTOR:PNP SILICON 30V 900MW	28480	1853-0001	1	
1853-0020	TRANSISTOR:SILICON PNP	28480	1853-0020	5	
1853-0038	TRANSISTOR:SILICON PNP	28480	1853-0038	2	
1854-0003	TRANSISTOR:NPN SILICON	28480	1854-0003	16	
1854-0022	TRANSISTOR:NPN SILICON	28480	1854-0022	1	
1854-0039	TRANSISTOR:SILICON 2N3053	02735	2N3053	4	
1854-0063	TRANSISTOR:NPN SILICON 2N3055	02735	2N3055	4	
1854-0071	TRANSISTOR:SILICON NPN	28480	1854-0071	7	
1854-0079	TRANSISTOR:SILICON 2N3439	02735	2N3439	3	
1854-0080	TRANSISTOR:SILICON	28480	1854-0080	2	
1854-0221	TRANSISTOR DUAL:SILICON NPN	28480	1854-0221	2	
1854-0232	TRANSISTOR:SILICON NPN	28480	1854-0232	3	
1854-0237	TRANSISTOR:SILICON NPN 2N3738	04713	2N3738	2	
1855-0001	TRANSISTOR:SILICON	03508	2N1671A	1	
1855-0049	TRANSISTOR:DUAL CHANNEL	28480	1855-0049	1	
1855-0062	TRANSISTOR:FIELD EFFECT 30V	28480	1855-0062	1	
1901-0028	DIODE:SILICON 400 PIV 0.5 AMP	28480	1901-0028	2	
1901-0029	DIODE:SILICON 600 PIV	28480	1901-0029	9	
1901-0030	DIODE:SILICON 800 PIV	28480	1901-0030	9	
1901-0033	DIODE:SILICON 100MA 180WV	28480	1901-0033	56	
1901-0084	DIODE ASSY:4000 PIV	28480	1901-0084	2	
1901-0096	DIODE:SILICON 120V	28480	1901-0096	2	
1901-0200	DIODE:SILICON 100 PIV 3A	02735	1N4998	8	
1901-0356	DIODE:SILICON 250WV	28480	1901-0356	1	
1902-0025	DIODE,BREAKDOWN:10.0V 5% 400 MW	28480	1902-0025	2	
1902-0038	DIODE BREAKDOWN:45.3V 5%	28480	1902-0038	1	
1902-0041	DIODE:BREAKDOWN 5.11V 5% 400MW	28480	1902-0041	1	
1902-0176	DIODE BREAKDOWN:47.5V 1W	28480	1902-0176	4	
1902-0188	DIODE:BREAKDOWN 4.12V 5%	28480	1902-0188	1	
1902-0197	DIODE BREAKDOWN:SILICON 82.5V 5%	28480	1902-0197	1	
1902-0215	DIODE,BREAKDOWN:6.49V 5%	28480	1902-0215	1	
1902-0554	DIODE BREAKDOWN:10V 1W	28480	1902-0554	1	
1902-3002	DIODE BREAKDOWN:2.37V 5%	28480	1902-3002	1	
1902-3139	DIODE BREAKDOWN:SILICON 8.25V 5%	28480	1902-3139	2	
1902-3182	DIODE BREAKDOWN:SILICON 12.1V 5%	28480	1902-3182	2	
1902-3290	DIODE BREAKDOWN:SILICON 31.6V 5%	28480	1902-3290	1	
1902-3323	DIODE BREAKDOWN:42.2V 5%	28480	1902-3323	2	
1902-3369	DIODE BREAKDOWN:61.9V 400MW	28480	1902-3369	2	
1902-3381	DIODE BREAKDOWN:68.1V 400MW	28480	1902-3381	4	
1902-3428	DIODE BREAKDOWN:SILICON 100V 5%	28480	1902-3428	1	
1903-0002	DIODE:SILICON 4-LAYER 20V	28480	1903-0002	1	
1923-0043	ELECTRON TUBE:PENTODE 6EW6	33173	6EW6	1	
1923-0045	ELECTRON TUBE: 7239 PENTODE	33173	7239	1	
1923-0046	ELECTRON TUBE: 6EJ7 (EF 184) PENTODE	73445	6EJ7 (EF184)	1	
1923-0048	ELECTRON TUBE: 8068 BEAM PENTODE	33173	8068	2	
1924-0001	ELECTRON TUBE:5915 PENTAGRID	86684	5915	1	
1932-0009	ELECTRON TUBE: 5965 DUAL TRIODE	33173	5965	1	
1932-0030	ELECTRON TUBE:12AX7	02735	12AX7	3	
1932-0049	ELECTRON TUBE:CK647	07933	CK647	3	
1940-0007	ELECTRON TUBE:0B2	02735	0B2	1	

See introduction to this section for ordering information

Table 6-2. Replaceable Parts (Cont.)

Part No.	Description #	Mfr.	Mfr. Part No.	TQ	RS
1940-0013	ELECTRON TUBE:82.0 +/- 1V	74276	Z82R7	3	
2100-0043	R:VAR COMP 500K OHM 10% LIN 2W	28480	2100-0043	1	
2100-0073	R:VAR COMP 125K OHM 20% LIN 1/4W	28480	2100-0073	1	
2100-0361	R:VAR COMP 2000 OHM 30% LIN 1/8W	28480	2100-0361	2	
2100-0752	R:VAR WW 50K OHM 3% LIN 4W	28480	2100-0752	4	
2100-0753	R:VAR COMP 500K OHM 20% LIN 1/2W	28480	2100-0753	1	
2100-0968	R:VAR COMP 10K OHM 30% 20CCLOG 1/4W	28480	2100-0968	1	
2100-1471	R:VAR COMP 50K OHM 30% LIN 1/8W	28480	2100-1471	1	
2100-1472	R:VAR COMP 25K OHM 30% LIN 1/8W	28480	2100-1472	2	
2100-1473	R:VAR COMP 15K OHM 30% LIN 1/8W	28480	2100-1473	2	
2100-1474	R:VAR COMP 5K OHM 30% LIN 1/8W	28480	2100-1474	5	
2100-1523	R:VAR WW 2K OHM 5% 1W	28480	2100-1523	1	
2100-1758	R:VAR WW 1K OHM 10% LIN 1/2W	28480	2100-1758	6	
2100-1760	R:VAR WW 5K OHM 10% LIN 1/2W	28480	2100-1760	6	
2110-0002	FUSE:CARTRIDGE 2 AMP 3 AG	75915	312.002	1	
2110-0004	FUSE:CARTRIDGE 1/4 AMP 250V	75915	3AG/CAT. 312.250	2	
2110-0014	FUSE:CARTRIDGE 4 AMP 125V SLOW BLOW	71400	MDX-4	1	
2110-0035	FUSE:CARTRIDGE 8 AMP SLOW BLOW	71400	MDL 8	1	
2110-0055	FUSE:CARTRIDGE 4 AMP 250V	75915	312006	1	
2110-0066	FUSE:0.1A 125V	75915	313.600	1	
2140-0092	LAMP:5V 60 MA	28480	2140-0092	2	
2140-0293	LAMP:INCANDESCENT 6.3V	71744	755	7	
3100-1501	SWITCH:ROTARY	28480	3100-1501	1	
3100-1861	SWITCH:ROTARY	28480	3100-1861	1	
3101-0011	SWITCH:SLIDE DPDT	42190	4603G1	1	
3101-0034	SWITCH:SLIDE 4PDT	42190	6633JQ	1	
3101-0041	SWITCH:TOGGLE DPST	88140	8906K370	1	
3101-0052	SWITCH:PUSHBUTTON SPST	82389	961 LESS HWD	1	
3101-0922	SWITCH:PUSHBUTTON	28480	3101-0922	1	
3101-1153	SWITCH:PUSHBUTTON	28480	3101-1153	5	
3160-0097	FAN:TUBE AXIAL	28480	3160-0097	1	
5000-0053	PLATE:FLUTED ALUMINUM	28480	5000-0053	1	
5000-0746	SIDE COVER	28480	5000-0746	1	
5060-0736	FRAME ASSY	28480	5060-0736	1	
5060-0763	HANDLE ASSY-SIDE	28480	5060-0763	1	
5060-0765	RETAINER-HANDLE ASSY.	28480	5060-0765	1	
5060-0767	FOOT ASSY:FM	28480	5060-0767	1	
5060-0777	KIT:RACK MOUNT	28480	5060-0777	1	
8120-0078	CABLE ASSY:POWER CORD	28480	8120-0078	1	
9100-0350	TRANSFORMER:POWER	28480	3100-0350	1	
9100-1748	TRANSFORMER:LOW VOLTAGE	28480	9100-1748	1	
00693-022	SUPPORT:TUBE	28480	00693-022	1	
00693-205	COUPLER:POT	28480	00693-205	1	
08690-0024	PANEL:REAR	28480	08690-0024	1	
08690-0012	CLAMP:CAPACITOR	28480	08690-0012	1	
08690-0016	COVER ASSY:TOP	28480	08690-0016	2	
08690-0017	COVER ASSY:BOTTOM	28480	08690-0017	2	
08690-0018	BRACKET:FUSEHOLDER	28480	08690-0018	1	
08690-0020	RF UNIT GROUNDING	28480	08690-0020	1	
08690-0022	PLATE:CONNECTOR	28480	08690-0022	1	
08690-2002	CAM	28480	08690-2002	2	
08690-2003	PLATE:DETENT	28480	08690-2003	2	

See introduction to this section for ordering information

Table 6-2. Replaceable Parts (Cont.)

Part No.	Description #	Mfr.	Mfr. Part No.	TQ	RS
08690-2004	SUPPORT:CAPACITOR CLAMP	28480	08690-2004	1	
08690-2005	SUPPORT:REG. BOARD	28480	08690-2005	2	
08690-2006	WINDOW:PROTECTIVE	28480	08690-2006	1	
08690-2035	PIN:RF UNIT GUIDE	28480	08690-2035	2	
08690-2037	RAIL:UPPER GUIDE	28480	08690-2037	1	
08690-2038	RAIL:LOWER GUIDE	28480	08690-2038	1	
08690-4105	GLIDE:CORNER	28480	08690-4105	4	
08690-6005	PANEL:FRONT	28480	08690-6005	1	
08690-6012	BOARD ASSY:CALIBRATOR	28480	08690-6012	1	
08690-6016	BOARD ASSY:INTERCONNECTION	28480	08690-6016	1	
08690-6017	BOARD ASSY:HIGH VOLTAGE POWER SUPPLY	28480	08690-6017	1	
08690-6019	BOARD ASSY:SWEEP GENERATOR	28480	08690-6019	1	
08690-6020	BOARD ASSY:MARKER	28480	08690-6020	1	
08690-6022	BOARD ASSY:HEATER SUPPLY	28480	08690-6022	1	
08690-6023	BOARD ASSY:EXTENDER	28480	08690-6023	1	
08690-6025	BOARD ASSY:RECTIFIER	28480	08690-6025	1	
08690-6028	BOARD ASSY:AIC AMPLIFIER	28480	08690-6028	1	
08690-6031	BOARD ASSY:HELIX AMPLIFIER	28480	08690-6031	1	
08690-6032	BOARD ASSY:REGULATOR	28480	08690-6032	1	
08690-6033	BOARD ASSY:LOW VOLTAGE POWER SUPPLY	28480	08690-6033	1	
08690-6034	BOARD ASSY:RECIPROCAL AMPLIFIER	28480	08690-6034	1	
08690-6040	BOARD ASSY:TRIMPOT	28480	08690-6040	1	
08690-6041	PANEL ASSY:FRONT	28480	08690-6041	1	
08690-6042	DRIVE ASSY:DIAL	28480	08690-6042	1	

See introduction to this section for ordering information

TABLE 6-3.
CODE LIST OF MANUFACTURERS

The following code numbers are from the Federal Supply Code for Manufacturers Cataloging Handbooks H4-1 (Name to Code) and H4-2 (Code to Name) and their latest supplements. The date of revision and the date of the supplements used appear at the bottom of each page. Alphabetical codes have been arbitrarily assigned to suppliers not appearing in the H4 Handbooks.

Code No.	Manufacturer	Address	Code No.	Manufacturer	Address	Code No.	Manufacturer	Address
00000	U. S. A. Common	Any supplier of U. S.	05397	Union Carbide Corp., Linde Div.	Kemet Dept., Cleveland, Ohio	11242	Bay State Electronics Corp.	Waltham, Mass.
00136	McCoy Electronics	Mount Holly Springs, Pa.	05593	Illumitronic Engineering Co.	Sunnyvale, Calif.	11312	Teledyne Inc., Microwave Div.	Palo Alto, Calif.
00213	Sage Electronics Corp.	Rochester, N. Y.	05616	Cosmo Plastic (Cosmo Electrical Spec. Co.)	Cleveland, Ohio	11314	National Seal	Downey, Calif.
00287	Cemco Inc.	Danielson, Conn.	05624	Barber Colman Co.	Rockford, Ill.	11534	Duncan Electronics Inc.	Costa Mesa, Calif.
00334	Humidial	Colton, Calif.	05728	Tiffen Optical Co.	Roslyn Heights, Long Island, N. Y.	11711	General Instrument Corp., Semiconductor Div., Products Group	Newark, N. J.
00348	Microtron Co., Inc.	Valley Stream, N. Y.	05729	Metro-Tel Corp.	Westbury, N. Y.	11717	Imperial Electronic, Inc.	Buena Park, Calif.
00373	Garlock Inc.	Cherry Hill, N. J.	05783	Stewart Engineering Co.	Santa Cruz, Calif.	11870	Melabs, Inc.	Palo Alto, Calif.
00656	Aerovox Corp.	New Bedford, Mass.	05820	Wakefield Engineering Inc.	Wakefield, Mass.	12136	Philadelphia Handle Co.	Camden, N. J.
00779	Amp. Inc.	Harrisburg, Pa.	06004	Bassick Co., Div. of Stewart Warner Corp.	Bridgeport, Conn.	12361	Grove Mfg. Co., Inc.	Shady Grove, Pa.
00781	Aircraft Radio Corp.	Boonton, N. J.	06090	Raychem Corp.	Redwood City, Calif.	12574	Gulton Ind. Inc. Data System Div.	Albuquerque, N. M.
00815	Northern Engineering Laboratories, Inc.	Burlington, Wis.	06175	Bausch and Lomb Optical Co.	Rochester, N. Y.	12697	Clarostat Mfg. Co.	Dover, N. H.
00853	Sangamo Electric Co., Pickens Div.	Pickens, S. C.	06402	E. T. A. Products Co. of America	Chicago, Ill.	12728	Elmar Filter Corp.	W. Haven, Conn.
00866	Goe Engineering Co.	City of Industry, Cal.	06540	Amatom Electronic Hardware Co., Inc.	New Rochelle, N. Y.	12859	Nippon Electric Co., Ltd.	Tokyo, Japan
00891	Carl E. Holmes Corp.	Los Angeles, Calif.	06555	Beede Electrical Instrument Co., Inc.	Indianapolis, Ind.	12881	Metex Electronics Corp.	Clark, N. J.
00929	Microtab Inc.	Livingston, N. J.	06666	General Devices Co., Inc.	Phoenix, Ariz.	12930	Delta Semiconductor Inc.	Newport Beach, Calif.
01002	General Electric Co., Capacitor Dept.	Hudson Falls, N. Y.	06751	Semcor Div. Components Inc.	Phoenix, Ariz.	12930	Dickson Electronics Corp.	Scottsdale, Arizona
01009	Alden Products Co.	Brockton, Mass.	06812	Torrington Mfg. Co., West Div.	Van Nuys, Calif.	1310.	Thermolloy	Dallas, Texas
01121	Allen Bradley Co.	Milwaukee, Wis.	06980	Varian Assoc. Eimac Div.	San Carlos, Calif.	13396	Telefunken (GmbH)	Hanover, Germany
01255	Litton Industries, Inc.	Beverly Hills, Calif.	07088	Kelvin Electric Co.	Van Nuys, Calif.	13835	Midland-Wright Div. of Pacific Industries, Inc.	Kansas City, Kansas
01281	TRW Semiconductors, Inc.	Lawndale, Calif.	07126	Digitran Co.	Pasadena, Calif.	14099	Sem-Tech	Newbury Park, Calif.
01295	Texas Instruments, Inc., Transistor Products Div.	Dallas, Texas	07137	Transistor Electronics Corp.	Minneapolis, Minn.	14193	Calif. Resistor Corp.	Santa Monica, Calif.
01349	The Alliance Mfg. Co.	Alliance, Ohio	07138	Westinghouse Electric Corp. Electronic Tube Div.	Elmira, N. Y.	14298	American Components, Inc.	Conshohocken, Pa.
01589	Pacific Relays, Inc.	Van Nuys, Calif.	07149	Filmom Corp.	New York, N. Y.	14433	ITT Semiconductor, A Div. of Int. Telephone & Telegraph Corp.	West Palm Beach, Fla.
01930	Amerock Corp.	Rockford, Ill.	07233	Cinch-Graphik Co.	City of Industry, Calif.	14493	Hewlett-Packard Company	Loveland, Colo.
01961	Pulse Engineering Co.	Santa Clara, Calif.	07261	Avnet Corp.	Culver City, Calif.	14655	Cornell Dublier Electric Corp.	Newark, N. J.
02114	Ferroxcube Corp. of America	Saugerties, N. Y.	07263	Fairchild Camera & Inst. Corp. Semiconductor Div.	Mountain View, Calif.	14674	Corning Glass Works	Corning, N. Y.
02116	Wheelock Signals, Inc.	Long Branch, N. J.	07322	Minnesota Rubber Co.	Minneapolis, Minn.	14752	Electro Cube Inc.	San Gabriel, Calif.
02286	Cole Rubber and Plastics Inc.	Sunnyvale, Calif.	07387	Birtcher Corp., The	Monterey Park, Calif.	14960	Williams Mfg. Co.	San Jose, Calif.
02660	Amphenol-Borg Electronics Corp.	Chicago, Ill.	07397	Sylvania Elect. Prod. Inc., Mt. View Operations	Mountain View, Calif.	15203	Webster Electronics Co.	New York, N. Y.
02735	Radio Corp. of America, Semiconductor and Materials Div.	Somerville, N. J.	07700	Technical Wire Products Inc.	Cranford, N. J.	15287	Scionics Corp.	Northridge, Calif.
02771	Vocaline Co. of America, Inc.	Old Saybrook, Conn.	07910	Continental Device Corp.	Hawthorne, Calif.	15291	Adjustable Bushing Co.	N. Hollywood, Calif.
02777	Hookins Engineering Co.	San Fernando, Calif.	07933	Raytheon Mfg. Co., Semiconductor Div.	Mountain View, Calif.	15558	Micron Electronics	Garden City, Long Island, N. Y.
03508	G. E. Semiconductor Prod. Dept.	Syracuse, N. Y.	07980	Hewlett-Packard Co., Boonton Radio Div.	Rockaway, N. J.	15566	Amprobe Inst. Corp.	Lynbrook, N. Y.
03705	Apex Machine & Tool Co.	Dayton, Ohio	08145	U. S. Engineering Co.	Los Angeles, Calif.	15631	Cabletronics	Costa Mesa, Calif.
03797	Eldema Corp.	Compton, Calif.	08289	Blinn, Delbert Co.	Pomona, Calif.	15772	Twentieth Century Coil Spring Co.	Santa Clara, Calif.
03877	Transitron Electric Corp.	Wakefield, Mass.	08358	Burgess Battery Co.	Niagara Falls, Ontario, Canada	15801	Fenwal Elect. Inc.	Frammingham, Mass.
03888	Pyrofilm Resistor Co., Inc.	Cedar Knolls, N. J.	08354	Deutsch Fastener Corp.	Los Angeles, Calif.	15818	Amelco Inc.	Mt. View, Calif.
03954	Singer Co., Diehl Div. FINDERNE Plant	Sumerville, N. J.	08664	Bristol Co., The	Waterbury, Conn.	16037	Spruce Pine Mica Co.	Spruce Pine, N. C.
04009	Arrow, Hart and Hegeman Elect. Co.	Hartford, Conn.	08717	Sloan Company	Sun Valley, Calif.	16179	Omni-Spectra Inc.	Detroit, Ill.
04013	Taurus Corp.	Lambertville, N. J.	08718	ITT Cannon Electric Inc., Phoenix Div.	Phoenix, Arizona	16352	Computer Diode Corp.	Lodi, N. J.
04062	Arco Electronic Inc.	Great Neck, N. Y.	08792	CBS Electronics Semiconductor Operations Div. of C. B. S. Inc.	Lowell, Mass.	16688	Ideal Prec. Meter Co., Inc. De Jur Meter Div.	Brooklyn, N. Y.
04222	Hi-Q Division of Aerovox	Myrtle Beach, S. C.	08984	Mei-Rain	Indianapolis, Ind.	16758	Delco Radio Div. of G. M. Corp.	Kokoma, Ind.
04354	Precision Paper Tube Co.	Wheeling, Ill.	09026	Babcock Relays Div.	Costa Mesa, Calif.	17109	Thermonetics Inc.	Canoga Park, Calif.
04404	Dymec Division of Hewlett-Packard Co.	Palo Alto, Calif.	09134	Texas Capacitor Co.	Houston, Texas	17474	Tranex Company	Mountain View, Calif.
04651	Sylvania Electric Products, Microwave Device Div.	Mountain View, Calif.	09145	Tech. Ind. Inc. Atchm Elect.	Burbank, Calif.	17675	Hamlin Metal Products Corp.	Akron, Ohio
04713	Motorsola, Inc., Semiconductor Prod. Div.	Phoenix, Arizona	09250	Electro Assemblies, Inc.	Chicago, Ill.	17745	Angstrom Prec. Inc.	No. Hollywood, Calif.
04732	Filttron Co., Inc. Western Div.	Culver City, Calif.	09569	Mallory Battery Co. of Canada, Ltd.	Toronto, Ontario, Canada	17870	McGraw-Edison Co.	Manchester, N. H.
04773	Automatic Electric Co.	Northlake, Ill.	10214	General Transistor Western Corp.	Los Angeles, Calif.	18042	Power Design Pacific Inc.	Palo Alto, Calif.
04796	Sequoia Wire Co.	Redwood City, Calif.	10411	Ti-Tal, Inc.	Berkeley, Calif.	18083	Clevite Corp., Semiconductor Div.	Palo Alto, Calif.
04811	Precision Coil Spring Co.	El Monte, Calif.	10646	Carborundum Co.	Niagara Falls, N. Y.	18324	Signetics Corp.	Sunnyvale, Calif.
04870	P. M. Motor Company	Westchester, Ill.	11236	CTS of Berne, Inc.	Berne, Ind.	18476	Ty-Car Mfg. Co., Inc.	Holliston, Mass.
04919	Component Mfg. Service Co.	W. Bridgewater, Mass.	11237	Chicago Telephone of California, Inc.	So. Pasadena, Calif.	18486	TRW Elect. Comp. Div.	Des Plaines, Ill.
05006	Twentieth Century Plastics, Inc.	Los Angeles, Calif.				18583	Corusc Instrument, Inc.	Mt. Kisco, N. Y.
05277	Westinghouse Electric Corp. Semi-Conductor Dept.	Youngwood, Pa.				18873	E. I. DuPont and Co., Inc.	Wilmington, Del.
05347	Ultronix Inc.	San Mateo, Calif.				18911	Durant Mfg. Co.	Milwaukee, Wis.
						19315	The Bendix Corp., Navigation & Control Div.	Teterboro, N. J.
						19500	Thomas A. Edison Industries, Div. of McGraw-Edison Co.	West Orange, N. J.
						19589	Concoa	Baldwin Park, Calif.
						19644	LRC Electronics	Horseheads, N. Y.
						19701	Electra Mfg. Co.	Independence, Kansas

TABLE 6-3.
CODE LIST OF MANUFACTURERS (Cont'd)

Code No.	Manufacturer	Address	Code No.	Manufacturer	Address	Code No.	Manufacturer	Address
20183	General Atronic Corp.	Philadelphia, Pa.	71436	Chicago Condenser Corp.	Chicago, Ill.	77252	Philadelphia Steel and Wire Corp.	Philadelphia, Pa.
21226	Executone, Inc.	Long Island City, N. Y.	71447	Calif. Spring Co., Inc.	Pico-Rivera, Calif.	77342	American Machine & Foundry Co. Potter & Brumfield Div.	Princeton, Ind.
21335	Fafnir Bearing Co., The	New Britain, Conn.	71450	CTS Corp.	Elkhart, Ind.	77630	TRW Electronic Components Div.	Camden, N. J.
21520	Fansteel Metallurgical Corp.	N. Chicago, Ill.	71468	ITT Cannon Electric Inc.	Los Angeles, Calif.	77638	General Instrument Corp., Rectifier Div.	Brooklyn, N. Y.
23783	British Radio Electronics Ltd.	Washington, D. C.	71471	Cinema, Div. Aerovox Corp.	Burbank, Calif.	77764	Resistance Products Co.	Harrisburg, Pa.
24455	G. E. Lamp Division	Nela Park, Cleveland, Ohio	71482	C. P. Clare & Co.	Chicago, Ill.	77969	Rubbercraft Corp. of Calif.	Torrance, Calif.
24655	General Radio Co.	West Concord, Mass.	71590	Centralab Div. of Globe Union Inc.	Milwaukee, Wis.	78189	Shakeproof Division of Illinois Tool Works	Elgin, Ill.
24681	Memcor Inc., Comp. Div.	Huntington, Ind.	71616	Commercial Plastics Co.	Chicago, Ill.	78283	Signal Indicator Corp.	New York, N. Y.
26365	Gires Reproducer Corp.	New Rochelle, N. Y.	71700	Cornish Wire Co., The	New York, N. Y.	78290	Struthers-Dunn Inc.	Pitman, N. J.
26462	Grobet File Co. of America, Inc.	Carlstadt, N. J.	71707	Coto Coil Co., Inc.	Providence, R. I.	78452	Thompson-Bremer & Co.	Chicago, Ill.
26992	Hamilton Watch Co.	Lancaster, Pa.	71744	Chicago Miniature Lamp Works	Chicago, Ill.	78471	Tilley Mfg. Co.	San Francisco, Calif.
28480	Hewlett-Packard Co.	Palo Alto, Calif.	71785	Cinch Mfg. Co., Howard B. Jones Div.	Chicago, Ill.	78488	Stackpole Carbon Co.	St. Marys, Pa.
28520	Heyman Mfg. Co.	Kenilworth, N. J.	71984	Dow Corning Corp.	Midland, Mich.	78493	Standard Thomson Corp.	Waltham, Mass.
33173	G. E. Receiving Tube Dept.	Owensboro, Ky.	72136	Electro Motive Mfg. Co., Inc.	Willimantic, Conn.	78553	Tinnerman Products, Inc.	Cleveland, Ohio
35434	Lectrohm Inc.	Chicago, Ill.	72619	Dialight Corp.	Brooklyn, N. Y.	78790	Transformer Engineers	San Gabriel, Calif.
36196	Stanwyck Coil Products Ltd.	Hawkesburg, Ontario, Canada	72656	Indiana General Corp., Electronics Div.	Keasby, N. J.	78947	Ucinite Co.	Newtonville, Mass.
36287	Cunningham, W. H. & Hill, Ltd.	Toronto Ontario, Canada	72659	General Instrument Corp., Cap. Div.	Newark, N. J.	79136	Waldes Kohinoor Inc.	Long Island City, N. Y.
37942	P. R. Mallory & Co. Inc.	Indianapolis, Ind.	72765	Drake Mfg. Co.	Harwood Heights, Ill.	79142	Veeder Root, Inc.	Hartford, Conn.
39543	Mechanical Industries Prod. Co.	Akron, Ohio	72825	Hugh H. Eby Inc.	Philadelphia, Pa.	79251	Wenco Mfg. Co.	Chicago, Ill.
40920	Miniature Precision Bearings, Inc.	Keene, N. H.	72928	Gudeman Co.	Chicago, Ill.	79727	Continental-Wirt Electronics Corp.	Philadelphia, Pa.
42190	Muter Co.	Chicago, Ill.	72964	Robert M. Hadley Co.	Los Angeles, Calif.	79963	Zierick Mfg. Corp.	New Rochelle, N. Y.
43990	C. A. Norgren Co.	Englewood, Colo.	72982	Erie Technological Products, Inc.	Erie, Pa.	80031	Mepco Division of Sessions Clock Co.	Morristown, N. J.
44655	Ohmite Mfg. Co.	Skokie, Ill.	73061	Hansen Mfg. Co., Inc.	Princeton, Ind.	80120	Schnitzer Alloy Products Co.	Elizabeth, N. J.
46384	Penn Eng. & Mfg. Corp.	Doylestown, Pa.	73076	H. M. Harper Co.	Chicago, Ill.	80131	Electronic Industries Association, Tube meeting EIA Standards-Washington, DC	Washington, DC
47904	Polaroid Corp.	Cambridge, Mass.	73138	Helipot Div. of Beckman Inst., Inc.	Fullerton, Calif.	80207	Unimax Switch, Div. Maxon Electronics Corp.	Wallingford, Conn.
48620	Precision Thermometer & Inst. Co.	Southampton, Pa.	73293	Hughes Products Division of Hughes Aircraft Co.	Newport Beach, Calif.	80223	United Transformer Corp.	New York, N. Y.
49956	Microwave & Power Tube Div.	Waltham, Mass.	73445	Amperex Elect. Co.	Hicksville, L. I., N. Y.	80248	Oxford Electric Corp.	Chicago, Ill.
52090	Rowan Controller Co.	Westminster, Md.	73506	Bradley Semiconductor Corp.	New Haven, Conn.	80294	Boutins Inc.	Riverside, Calif.
52983	Sanborn Company	Waltham, Mass.	73559	Carling Electric, Inc.	Hartford, Conn.	80411	Acro Div. of Robertshaw Controls Co.	Columbus, Ohio
54294	Shallcross Mfg. Co.	Selma, N. C.	73586	Circle F Mfg. Co.	Trenton, N. J.	80436	All Star Products Inc.	Defiance, Ohio
55026	Simpson Electric Co.	Chicago, Ill.	73582	George K. Garrett Co., Div. MSL Industries Inc.	Philadelphia, Pa.	80509	Avery Label Co.	Monrovia, Calif.
55933	Sonotone Corp.	Elmsford, N. Y.	73734	Federal Screw Products Inc.	Chicago, Ill.	80583	Hammartund Co., Inc.	New York, N. Y.
55938	Raytheon Co., Commercial Apparatus & Systems Div.	So. Norwalk, Conn.	73743	Fischer Special Mfg. Co.	Cincinnati, Ohio	80640	Stevens, Arnold, Co., Inc.	Boston, Mass.
56137	Spaullone Fibre Co., Inc.	Tonawanda, N. Y.	73793	General Industries Co., The	Elyria, Ohio	81030	International Instruments Inc.	Orange, Conn.
56289	Sprague Electric Co.	North Adams, Mass.	73846	Goshen Stamping & Tool Co.	Goshen, Ind.	81073	Grayhill Co.	LaGrange, Ill.
59446	Telex Corp.	Tulsa, Okla.	73939	JFD Electronics Corp.	Brooklyn, N. Y.	81095	Triad Transformer Corp.	Venice, Calif.
59730	Thomas & Betts Co.	Elizabeth, N. J.	73905	Jennings Radio Mfg. Corp.	San Jose, Calif.	81312	Winchester Elec. Div. Litton Ind., Inc.	Oakville, Conn.
60171	Triglett Electrical Inst. Co.	Bluffton, Ohio	73957	Groov-Pin Corp.	Ridgefield, N. J.	81349	Military Specification	
61775	Union Switch and Signal Div. of Westinghouse Air Brake Co.	Pittsburgh, Pa.	74276	Signalite Inc.	Neptune, N. J.	81483	International Rectifier Corp.	El Segundo, Calif.
62119	Universal Electric Co.	Owosso, Mich.	74455	J. H. Wines, and Sons	Winchester, Mass.	81541	Arpax Electronics, Inc.	Cambridge, Maryland
63743	Ward-Leonard Electric Co.	Mt. Vernon, N. Y.	74861	Industrial Condenser Corp.	Chicago, Ill.	81560	Barry Controls, Div. Barry Wright Corp.	Watertown, Mass.
64959	Western Electric Co., Inc.	New York, N. Y.	74868	R. F. Products Division of Amphenol-Borg Electronics Corp.	Danbury, Conn.	82042	Carter Precision Electric Co.	Skokie, Ill.
65092	Weston Inst. Inc. Weston-Newark	Newark, N. J.	74970	E. F. Johnson Co.	Waseca, Minn.	82047	Sperit Faraday Inc., Copper Hewitt Electric Div.	Hoboken, N. J.
65295	Wittex Mfg. Co.	Chicago, Ill.	75042	International Resistance Co.	Philadelphia, Pa.	82142	Jefferis Electronics Division of Speer Carbon Co.	Du Bois, Pa.
66346	Minnesota Mining & Mfg. Co. Revere Mincom Div.	St. Paul, Minn.	75378	CTS Knights Inc.	Sandwich, Ill.	82170	Fairchild Camera & Inst. Corp. Space & Defense System Div.	Paramus, N. J.
70276	Allen Mfg. Co.	Hartford, Conn.	75382	Kulka Electric Corporation	Mt. Vernon, N. Y.	82209	Maguire Industries, Inc.	Greenwich, Conn.
70309	Allied Control	New York, N. Y.	75818	Lenz Electric Mfg. Co.	Chicago, Ill.	82219	Sylvania Electric Prod., Inc. Electronic Tube Division	Emporium, Pa.
70313	Allmetal Screw Product Co., Inc.	Garden City, N. Y.	75915	Littlefuse, Inc.	Des Plaines, Ill.	82376	Astron Corp.	East Newark, Harrison, N. J.
70485	Atlantic India Rubber Works, Inc.	Chicago, Ill.	76005	Lord Mfg. Co.	Erie, Pa.	82589	Switchcraft, Inc.	Chicago, Ill.
70563	Amperex Co., Inc.	Union City, N. J.	76210	C. W. Marwedel	San Francisco, Calif.	82547	Metals & Controls Inc. Spencer Products	Attleboro, Mass.
70674	ADC Products Inc.	Minneapolis, Minn.	76433	General Instrument Corp., Motorola Division	Newark, N. J.	82768	Phillips-Advance Control Co.	Joliet, Ill.
70903	Belden Mfg. Co.	Chicago, Ill.	76487	James Millen Mfg. Co., Inc.	Malden, Mass.	82866	Research Products Corp.	Madison, Wis.
70998	Bird Electronic Corp.	Cleveland, Ohio	76493	J. W. Miller Co.	Los Angeles, Calif.	82877	Rotron Mfg. Co., Inc.	Woodstock, N. Y.
71002	Birnbach Radio Co.	New York, N. Y.	76530	Cinch-Monadnock, Div. of United Carr Fastener Corp.	San Leandro, Calif.	82893	Vector Electronic Co.	Glendale, Calif.
71041	Boston Gear Works Div. of Murray Co. of Texas	Quincy, Mass.	76545	Mueller Electric Co.	Cleveland, Ohio			
71218	Bud Radio, Inc.	Wiloughby, Ohio	76703	National Union	Newark, N. J.			
71286	Camloc Fastener Corp.	Paramus, N. J.	76854	Oak Manufacturing Co.	Crystal Lake, Ill.			
71313	Cardwell Condenser Corp.	Lindenhurst, L. I., N. Y.	77068	The Bendix Corp., Electrodynamics Div.	N. Hollywood, Calif.			
71400	Bussmann Mfg. Div. of McGraw-Edison Co.	St. Louis, Mo.	77075	Pacific Metals Co.	San Francisco, Calif.			
			77221	Phanostran Instrument and Electronic Co.	South Pasadena, Calif.			

From: FSC. Handbook Supplements
H4-1 Dated AUGUST 1966
H4-2 Dated NOV. 1962

TABLE 6-3.
CODE LIST OF MANUFACTURERS (Cont'd)

Code No.	Manufacturer	Address	Code No.	Manufacturer	Address	Code No.	Manufacturer	Address
83058	Carr Fastener Co.	Cambridge, Mass.	91418	Radio Materials Co.	Chicago, Ill.	97464	Industrial Retaining Ring Co.	Irvington, N. J.
83086	New Hampshire Ball Bearing, Inc.	Peterborough, N. H.	91506	Augat Inc.	Attleboro, Mass.	97539	Automatic & Precision Mfg.	Englewood, N. J.
83125	General Instrument Corp., Capacitor Div.	Darlington, S. C.	91637	Dale Electronics, Inc.	Columbus, Nebr.	97979	Reon Resistor Corp.	Yonkers, N. Y.
83148	ITT Wire and Cable Div.	Los Angeles, Calif.	91662	Elco Corp.	Willow Grove, Pa.	97983	Litton System Inc., Adler-Westrex Commun. Div.	New Rochelle, N. Y.
83186	Victory Eng. Corp.	Springfield, N. J.	91737	Gremar Mfg. Co., Inc.	Wakefield, Mass.	98141	R-Troncis, Inc.	Jamaica, N. Y.
83298	Bendix Corp., Red Bank Div.	Red Bank, N. J.	91827	K F Development Co.	Redwood City, Calif.	98159	Rubber Teck, Inc.	Gardena, Calif.
83315	Hubbell Corp.	Mundelein, Ill.	91886	Malco Mfg. Co., Inc.	Chicago, Ill.	98220	Hewlett-Packard Co., Moseley Div.	Pasadena, Calif.
83330	Smith, Herman H., Inc.	Brooklyn, N. Y.	91929	Honeywell Inc., Micro Switch Div.	Freeport, Ill.	98278	Microdot, Inc.	So. Pasadena, Calif.
83332	Tech Labs	Palisades Park, N. J.	91961	Nahm-Bros. Spring Co.	Oakland, Calif.	98291	Sealectro Corp.	Mamaroneck, N. Y.
83385	Central Screw Co.	Chicago, Ill.	92180	Triu-Connector Corp.	Peabody, Mass.	98376	Zero Mfg. Co.	Burbank, Calif.
83501	Gavitt Wire and Cable Co. Div. of Amerace Corp.	Brookfield, Mass.	92367	Elgeet Optical Co. Inc.	Rochester, N. Y.	98731	General Mills Inc., Electronics Div.	Minneapolis, Minn.
83594	Burroughs Corp. Electronic Tube Div.	Plainfield, N. J.	92607	Tensolite Insulated Wire Co., Inc.	Tarrytown, N. Y.	98734	Paeco Div. of Hewlett-Packard Co.	Palo Alto, Calif.
83740	Union Carbide Corp. Consumer Prod. Div.	New York, N. Y.	92702	IMC Magnetics Corp.	Wesbury Long Island, N. Y.	98821	North Hills Electronics, Inc.	Glen Cove, N. Y.
83777	Model Eng. and Mfg., Inc.	Huntington, Ind.	92966	Hudson Lamp Co.	Kearney, N. J.	98978	International Electronic Research Corp.	Burbank, Calif.
83821	Loyd Scruggs Co.	Festus, Mo.	93332	Sylvania Electric Prod. Inc. Semiconductor Div.	Woburn, Mass.	99109	Columbia Technical Corp.	New York, N. Y.
83942	Aeronautical Inst. & Radio Co.	Lodi, N. J.	93369	Robbins & Myers Inc.	Palisades Park, N. J.	99313	Varian Associates	Palo Alto, Calif.
84171	Arco Electronics Inc.	Great Neck, N. Y.	93410	Stevens Mfg. Co., Inc.	Mansfield, Ohio	99378	Atlee Corp.	Winchester, Mass.
84396	A. J. Glesener Co., Inc.	San Francisco, Calif.	93929	G. V. Controls	Livingston, N. J.	99515	Marshall Ind., Capacitor Div.	Monrovia, Calif.
84411	TRW Capacitor Div.	Ogallala, Neb.	94137	General Cable Corp.	Bayonne, N. J.	99707	Control Switch Division, Controls Co. of America	El Segundo, Calif.
84970	Sarkes Tarzian, Inc.	Bloomington, Ind.	94144	Raytheon Co., Comp. Div., Ind. Comp. Operations	Quincy, Mass.	99800	Delevan Electronics Corp.	East Aurora, N. Y.
85454	Boonton Molding Company	Boonton, N. J.	94148	Scientific Electronics Products, Inc.	Loveland, Colo.	99848	Wilco Corporation	Indianapolis, Ind.
85471	A. B. Boyd Co.	San Francisco, Calif.	94154	Wagner Elect. Corp., Tung-Sol Div.	Newark, N. J.	99934	Renbrandt, Inc.	Boston, Mass.
85474	R. M. Bracamonte & Co.	San Francisco, Calif.	94197	Curtiss-Wright Corp. Electronics Div.	East Paterson, N. J.	99942	Hoffman Electronics Corp. Semiconductor Div.	El Monte, Calif.
85660	Koiled Kords, Inc.	Hamden, Conn.	94222	South Chester Corp.	Chester, Pa.	99957	Technology Instrument Corp. of Calif.	Newbury Park, Calif.
85911	Seamless Rubber Co.	Chicago, Ill.	94330	Wire Cloth Products, Inc.	Bellwood, Ill.			
86197	Cliffon Precision Products Co., Inc.	Clifton Heights, Pa.	94682	Worcester Pressed Aluminum Corp.	Worcester, Mass.			
86579	Precision Rubber Products Corp.	Dayton, Ohio	94696	Magnecraft Electric Co.	Chicago, Ill.			
86684	Radio Corp. of America, Electronic Comp. & Devices Div.	Harrison, N. J.	95023	George A. Philbrick Researchers, Inc.	Boston, Mass.			
87034	Marco Industries	Anaheim, Calif.	95236	Allies Products Corp.,	Dania, Fla.			
87216	Philco Corporation (Lansdale Division)	Lansdale, Pa.	95238	Continental Connector Corp.	Woodside, N. Y.			
87473	Western Fibrous Glass Products Co.	San Francisco, Calif.	95263	Leecraft Mfg. Co., Inc.	Long Island, N. Y.			
87664	Van Waters & Rogers Inc.	San Francisco, Calif.	95265	National Coil Co.	Sheridan, Wyo.			
87930	Tower Mfg. Corp.	Providence, R. I.	95275	Vitramon, Inc.	Bridgeport, Conn.			
88140	Cutler-Hammer, Inc.	Lincoln, Ill.	95348	Gordos Corp.	Bloomfield, N. J.	9000F	Malco Tool and Die	Los Angeles, Calif.
88220	Gould-National Batteries, Inc.	St. Paul, Minn.	95354	Methode Mfg. Co.	Rolling Meadows, Ill.	9000Z	Willow Leather Products Corp.	Newark, N. J.
88698	General Mills, Inc.	Buffalo, N. Y.	95566	Arnold Engineering Co.	Marengo, Ill.	900AB	ETA	England
89231	Graybar Electric Co.	Oakland, Calif.	95712	Dage Electric Co., Inc.	Franklin, Ind.	900BB	Precision Instrument Components Co.	Van Nuys, Calif.
89473	G. E. Distributing Corp.	Schenectady, N. Y.	95984	Siemon Mfg. Co.	Wayne, Ill.	900CS	Hewlett-Packard Co., Colorado Springs	Colorado Springs, Colorado
89665	United Transformer Co.	Chicago, Ill.	95987	Wekesser Co.	Chicago, Ill.	900MM	Rubber Eng. & Development	Hayward, Calif.
90179	US Rubber Co., Consumer Ind. & Plastics Prod. Div.	Passaic, N. J.	96067	Huggins Laboratories	Sunnyvale, Calif.	900NN	A "N" D Mfg. Co.	San Jose, Calif.
90970	Bearing Engineering Co.	San Francisco, Calif.	96095	Hi-Q Div. of Aerovox Corp.	Olean, N. Y.	900QQ	Cooltron	Oakland, Calif.
91146	ITT Cannon Elect. Inc., Salem Div.	Salem, Mass.	96256	Thordarson-Meissner Inc.	Mt. Carmel, Ill.	900WW	California Eastern Lab.	Burlington, Calif.
91260	Connor Spring Mfg. Co.	San Francisco, Calif.	96296	Solar Manufacturing Co.	Los Angeles, Calif.	900YY	S. K. Smith Co.	Los Angeles, Calif.
91345	Milner Dial & Nameplate Co.	El Monte, Calif.	96330	Carlton Screw Co.	Chicago, Ill.			
			95341	Microwave Associates, Inc.	Burlington, Mass.			
			95501	Excel Transformer Co.	Oakland, Calif.			

THE FOLLOWING HP VENDORS HAVE NO NUMBER ASSIGNED IN THE LATEST SUPPLEMENT TO THE FEDERAL SUPPLY CODE FOR MANUFACTURERS HANDBOOK.

9000F	Malco Tool and Die	Los Angeles, Calif.
9000Z	Willow Leather Products Corp.	Newark, N. J.
900AB	ETA	England
900BB	Precision Instrument Components Co.	Van Nuys, Calif.
900CS	Hewlett-Packard Co., Colorado Springs	Colorado Springs, Colorado
900MM	Rubber Eng. & Development	Hayward, Calif.
900NN	A "N" D Mfg. Co.	San Jose, Calif.
900QQ	Cooltron	Oakland, Calif.
900WW	California Eastern Lab.	Burlington, Calif.
900YY	S. K. Smith Co.	Los Angeles, Calif.

SECTION VII

SCHEMATIC DIAGRAMS

7-1. INTRODUCTION.

7-2. Schematic presentations in this manual show electrical circuit operation and are not intended to serve as wiring diagrams. Figure 7-1 lists notes which apply to the schematic diagrams.

7-3. Some switch and circuit board assemblies are shown in part on different pages. To find a specific instrument component, refer to the "REFERENCE DESIGNATIONS" box which appears on each schematic diagram. Reference designations within assemblies are abbreviated. The full designation includes the assembly on which the component is mounted, and the

individual component designation. For example, Resistor R1 mounted on Assembly A1 has the complete reference designation of A1R1. Certain parts are not included on assemblies, and are classified as chassis parts. Chassis parts are assigned only the reference designation shown on the schematic diagram.

7-4. An asterisk indicates a factory selected part; the component value shown is the typical or most commonly selected value.

7-5. Component procurement information and specific component descriptions are included in Section VI. Refer to page 6-1 for information on how to order parts.

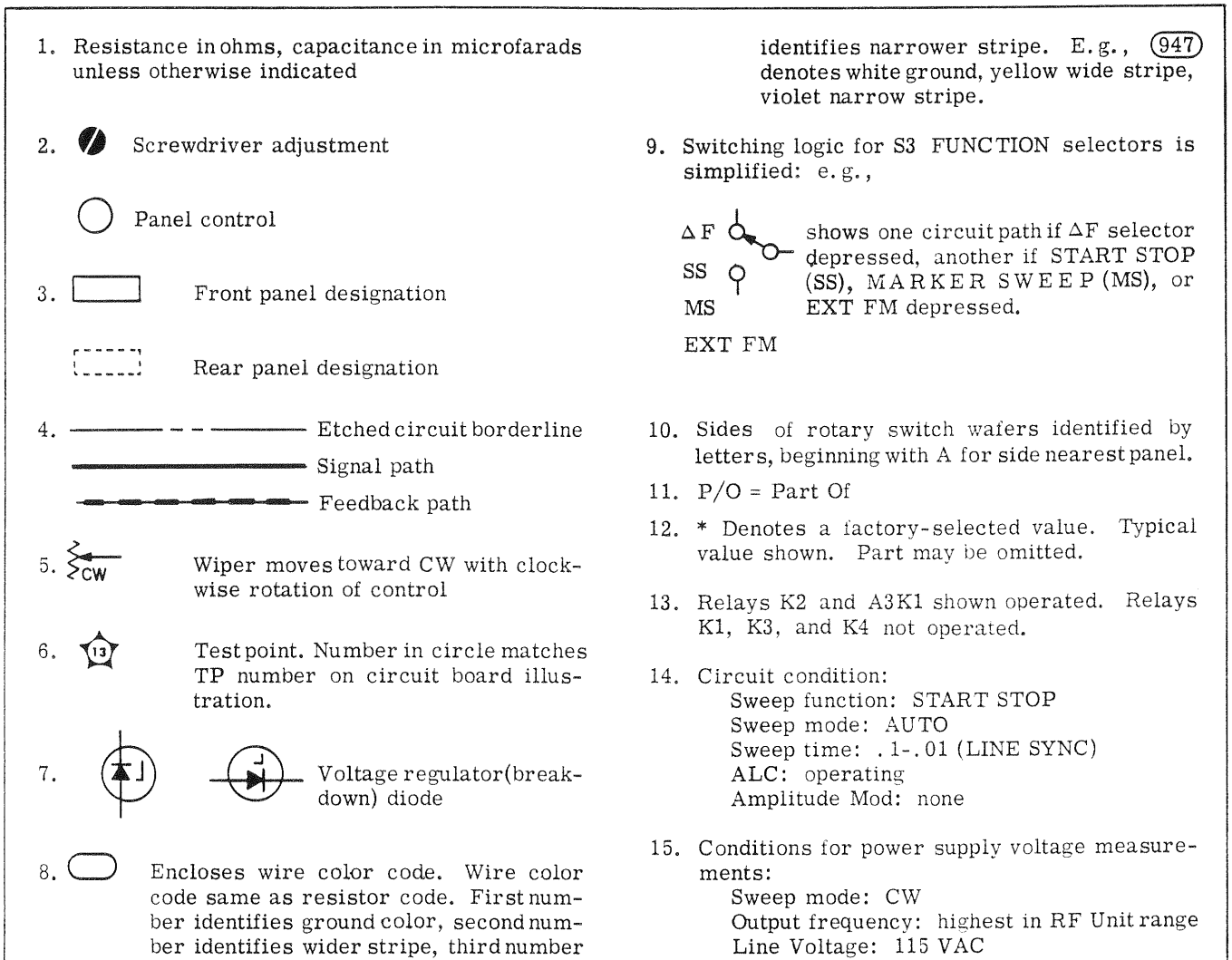
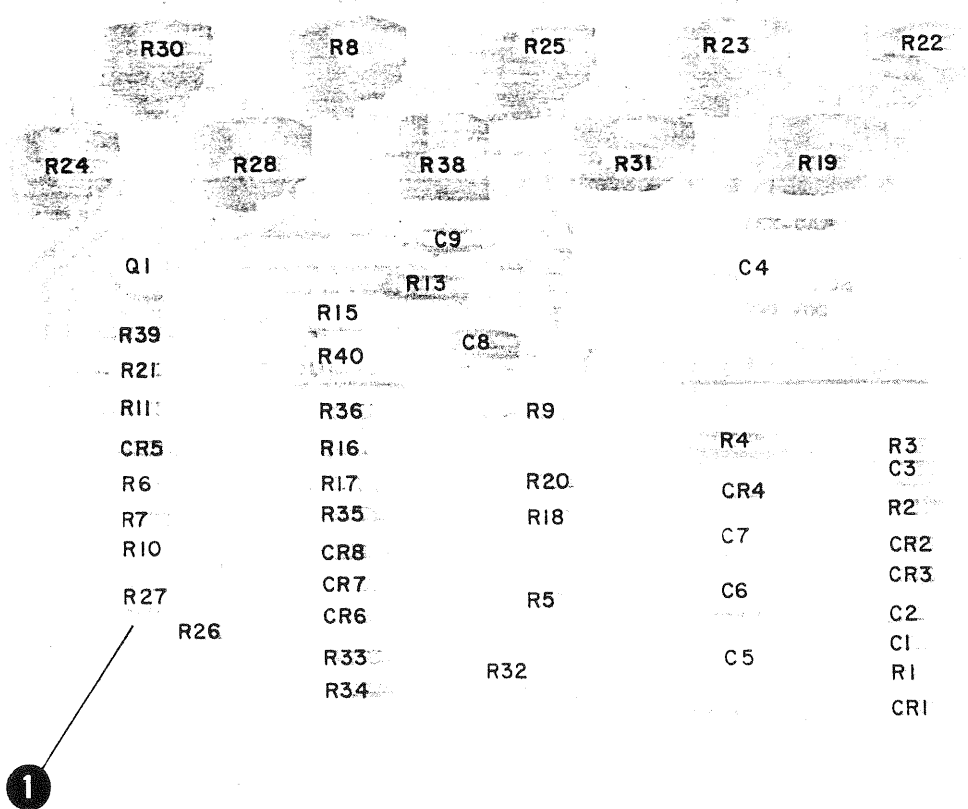
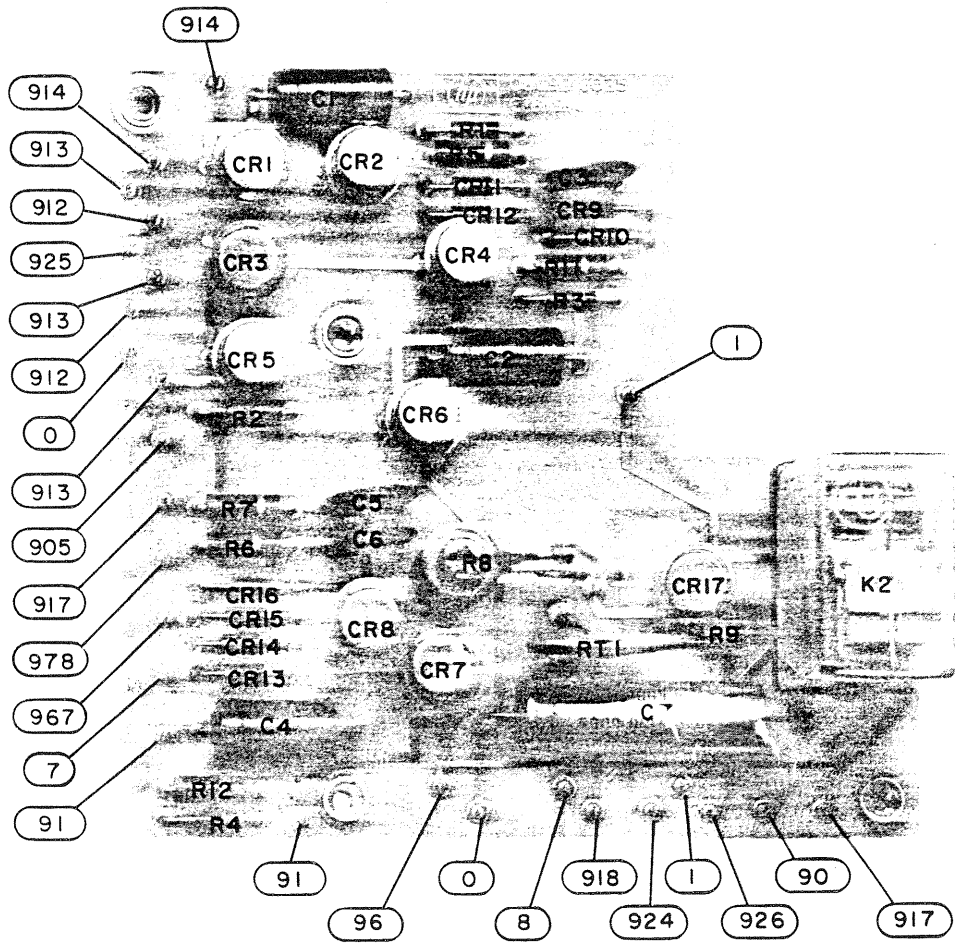

Figure 7-1. Schematic Diagram Notes



Model 8690B



Component Identification, Assembly A9

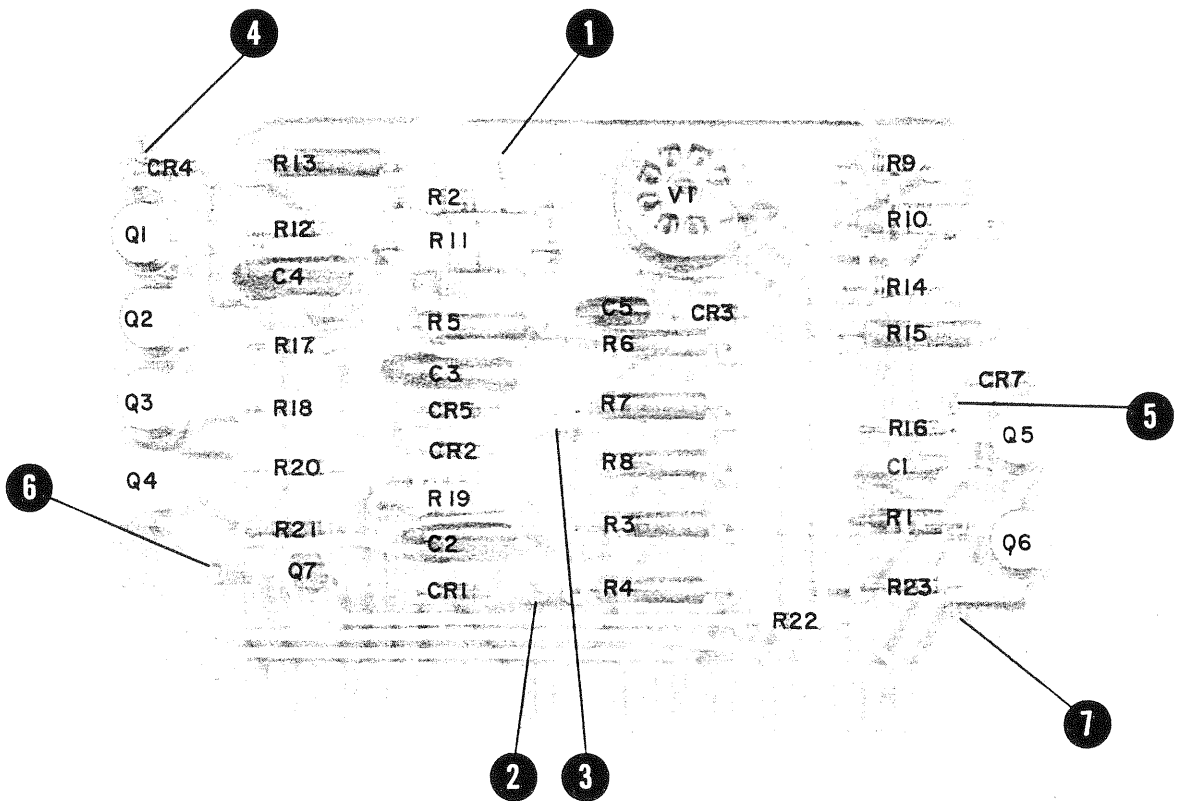

Component Identification, Assembly A10

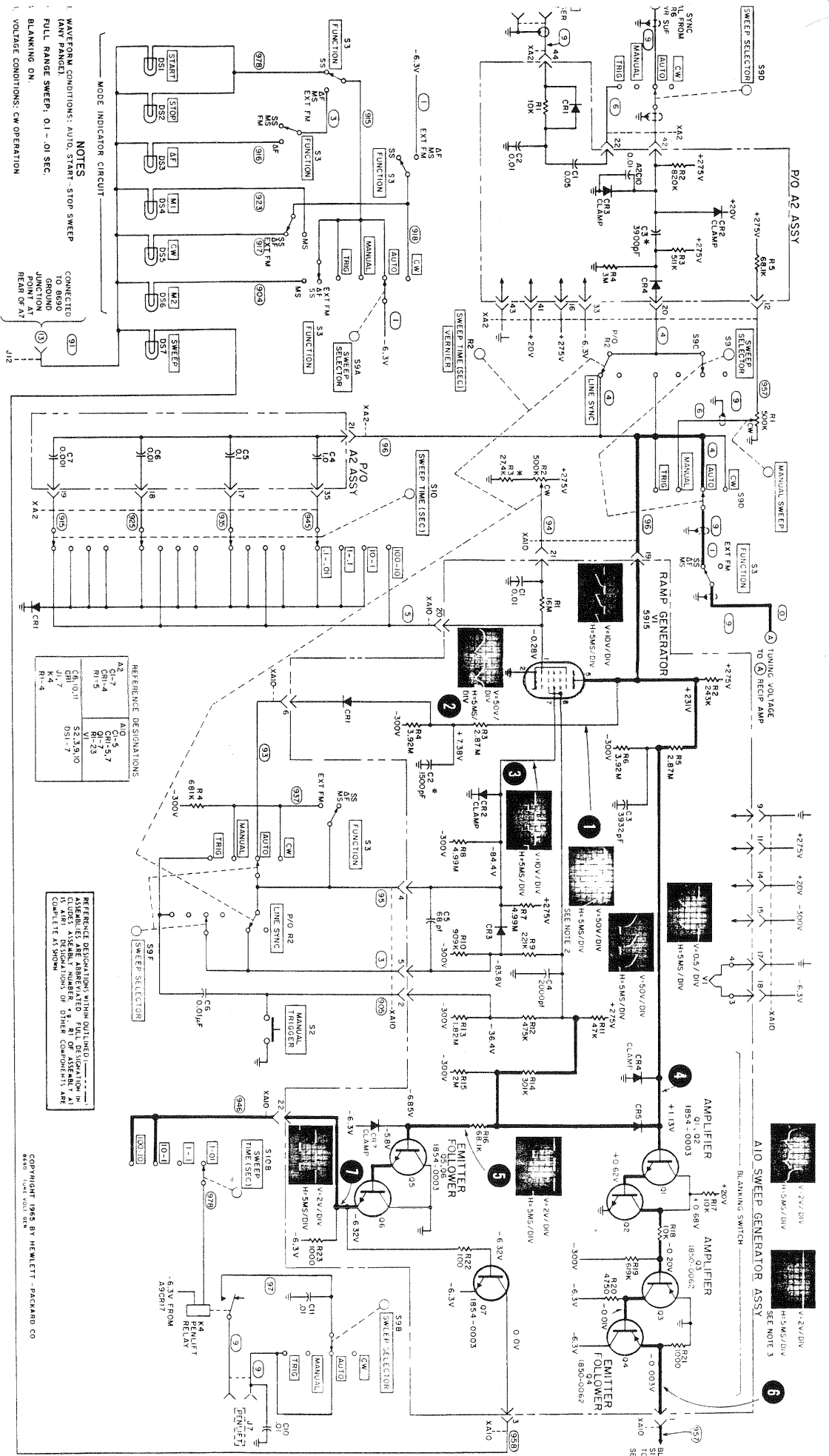

- 1. WAVEFORM CONDITIONS: AUTO, START, STOP SWEEP
- 2. FULL RANGE SWEEP: 0.1 - .01 SEC.
- 3. BLANKING ON
- 4. VOLTAGE CONDITIONS: CW OPERATION

MODE INDICATOR CIRCUIT

REFERENCE DESIGNATIONS

A2	6X-7	Q1-5
A10	6X-5	Q1-5
CH	6X-4	Q1-7
CR1	6X-7	Q1-7
CR2	6X-7	Q1-7
CR3	6X-7	Q1-7
CR4	6X-7	Q1-7
CR5	6X-7	Q1-7
CR6	6X-7	Q1-7
CR7	6X-7	Q1-7
CR8	6X-7	Q1-7
CR9	6X-7	Q1-7
CR10	6X-7	Q1-7
CR11	6X-7	Q1-7
CR12	6X-7	Q1-7
CR13	6X-7	Q1-7
CR14	6X-7	Q1-7
CR15	6X-7	Q1-7
CR16	6X-7	Q1-7
CR17	6X-7	Q1-7
CR18	6X-7	Q1-7
CR19	6X-7	Q1-7
CR20	6X-7	Q1-7
CR21	6X-7	Q1-7
CR22	6X-7	Q1-7
CR23	6X-7	Q1-7
CR24	6X-7	Q1-7
CR25	6X-7	Q1-7
CR26	6X-7	Q1-7
CR27	6X-7	Q1-7
CR28	6X-7	Q1-7
CR29	6X-7	Q1-7
CR30	6X-7	Q1-7
CR31	6X-7	Q1-7
CR32	6X-7	Q1-7
CR33	6X-7	Q1-7
CR34	6X-7	Q1-7
CR35	6X-7	Q1-7
CR36	6X-7	Q1-7
CR37	6X-7	Q1-7
CR38	6X-7	Q1-7
CR39	6X-7	Q1-7
CR40	6X-7	Q1-7
CR41	6X-7	Q1-7
CR42	6X-7	Q1-7
CR43	6X-7	Q1-7
CR44	6X-7	Q1-7
CR45	6X-7	Q1-7
CR46	6X-7	Q1-7
CR47	6X-7	Q1-7
CR48	6X-7	Q1-7
CR49	6X-7	Q1-7
CR50	6X-7	Q1-7
CR51	6X-7	Q1-7
CR52	6X-7	Q1-7
CR53	6X-7	Q1-7
CR54	6X-7	Q1-7
CR55	6X-7	Q1-7
CR56	6X-7	Q1-7
CR57	6X-7	Q1-7
CR58	6X-7	Q1-7
CR59	6X-7	Q1-7
CR60	6X-7	Q1-7
CR61	6X-7	Q1-7
CR62	6X-7	Q1-7
CR63	6X-7	Q1-7
CR64	6X-7	Q1-7
CR65	6X-7	Q1-7
CR66	6X-7	Q1-7
CR67	6X-7	Q1-7
CR68	6X-7	Q1-7
CR69	6X-7	Q1-7
CR70	6X-7	Q1-7
CR71	6X-7	Q1-7
CR72	6X-7	Q1-7
CR73	6X-7	Q1-7
CR74	6X-7	Q1-7
CR75	6X-7	Q1-7
CR76	6X-7	Q1-7
CR77	6X-7	Q1-7
CR78	6X-7	Q1-7
CR79	6X-7	Q1-7
CR80	6X-7	Q1-7
CR81	6X-7	Q1-7
CR82	6X-7	Q1-7
CR83	6X-7	Q1-7
CR84	6X-7	Q1-7
CR85	6X-7	Q1-7
CR86	6X-7	Q1-7
CR87	6X-7	Q1-7
CR88	6X-7	Q1-7
CR89	6X-7	Q1-7
CR90	6X-7	Q1-7
CR91	6X-7	Q1-7
CR92	6X-7	Q1-7
CR93	6X-7	Q1-7
CR94	6X-7	Q1-7
CR95	6X-7	Q1-7
CR96	6X-7	Q1-7
CR97	6X-7	Q1-7
CR98	6X-7	Q1-7
CR99	6X-7	Q1-7
CR100	6X-7	Q1-7

REFERENCE DESIGNATIONS WITHIN OUTLINED ASSEMBLIES ARE ABBREVIATED FULL DESIGNATION IN PARENTHESES. DESIGNATIONS OF OTHER COMPONENTS ARE COMPLETE AS SHOWN.

Copyright 1965, by Hewlett-Packard Co.
9540 100-0003

Figure 7-2. FREQUENCY CONTROL SECTION
Tuning Voltage Generator with
Blanking and Pen Lift Circuits

Model 8690B

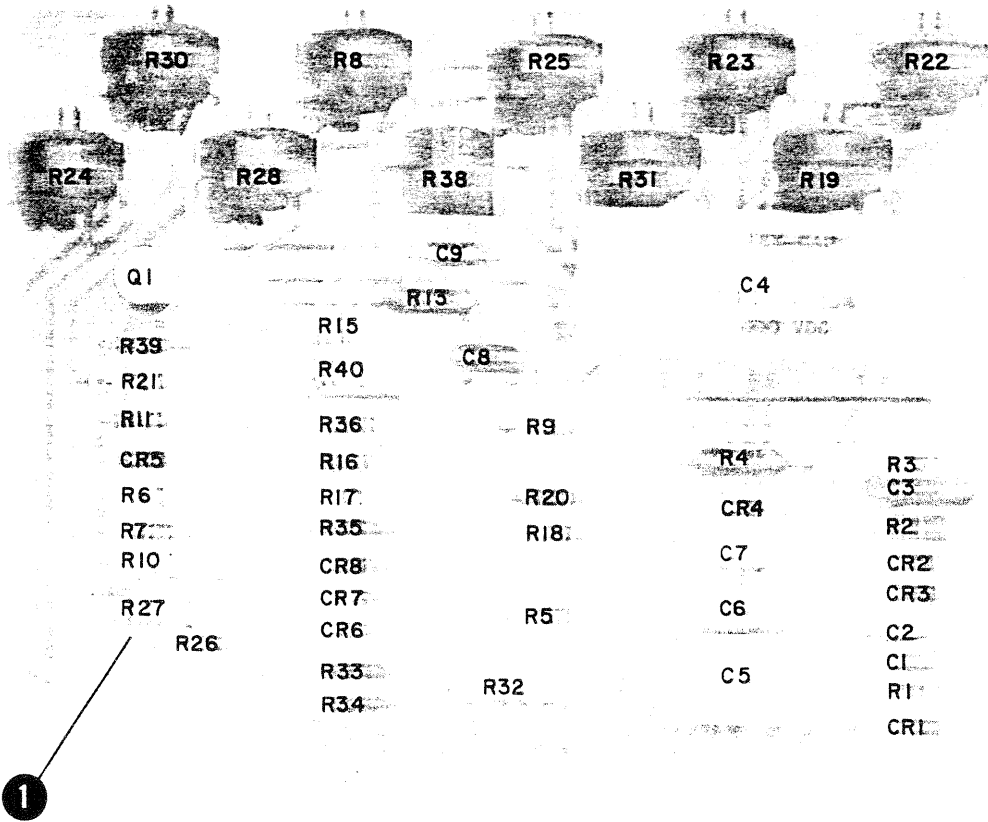

Component Identification, Assembly A2

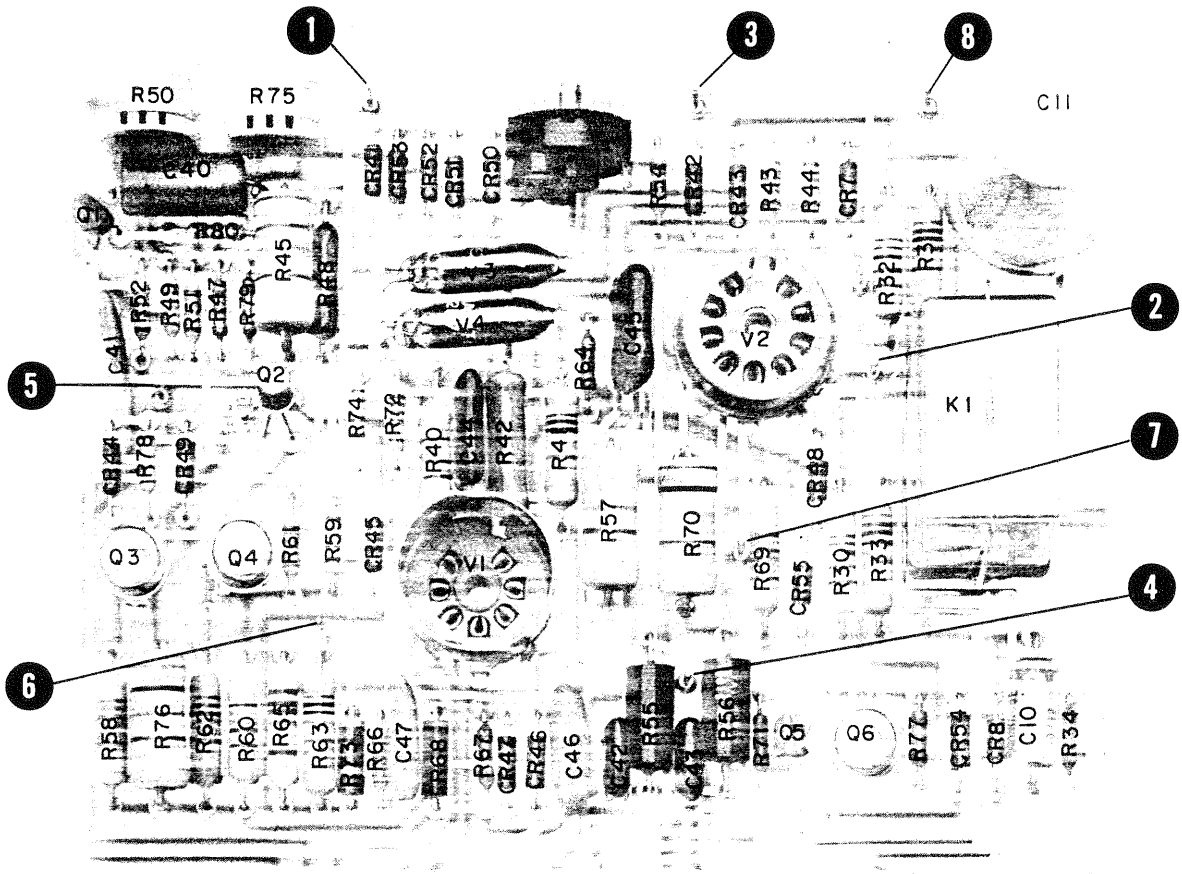

Component Identification, Assembly A3

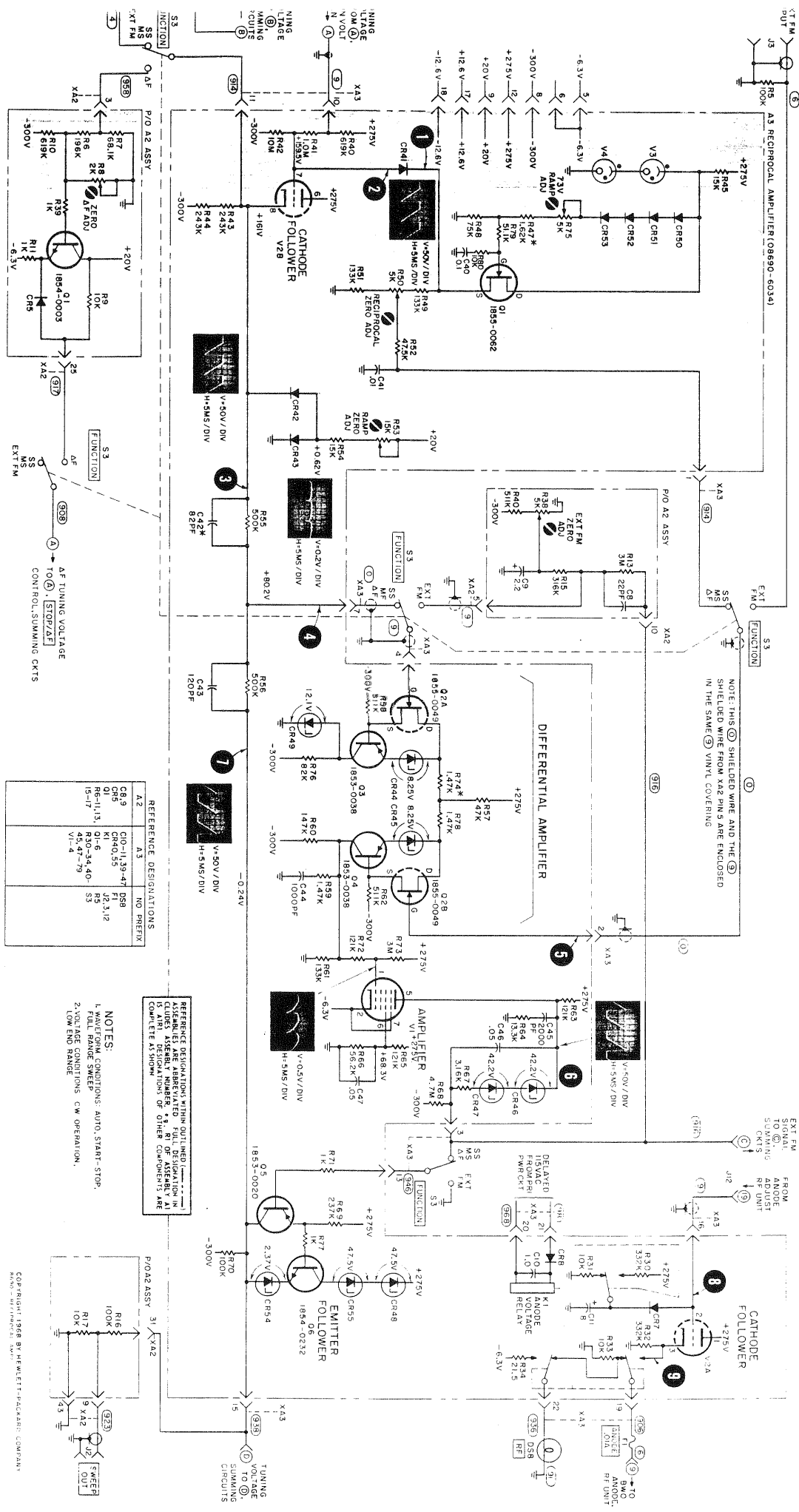
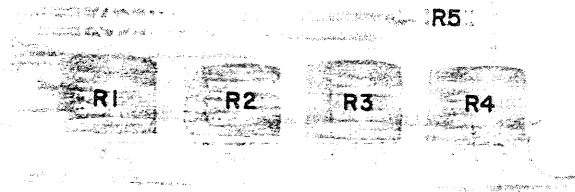

Figure 7-3. FREQUENCY CONTROL SECTION
Reciprocal Amplifier



Component Identification, Assembly A1

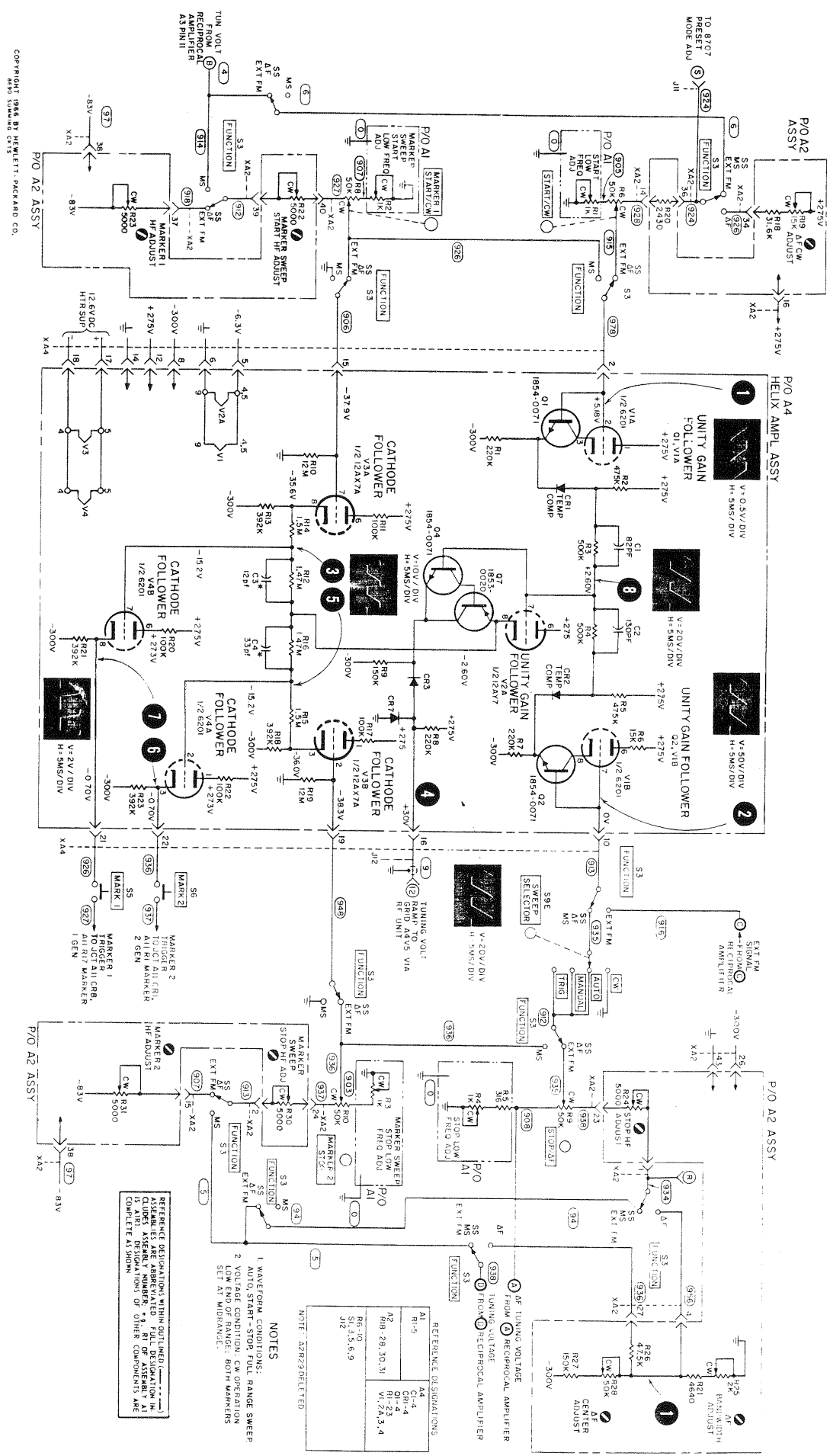
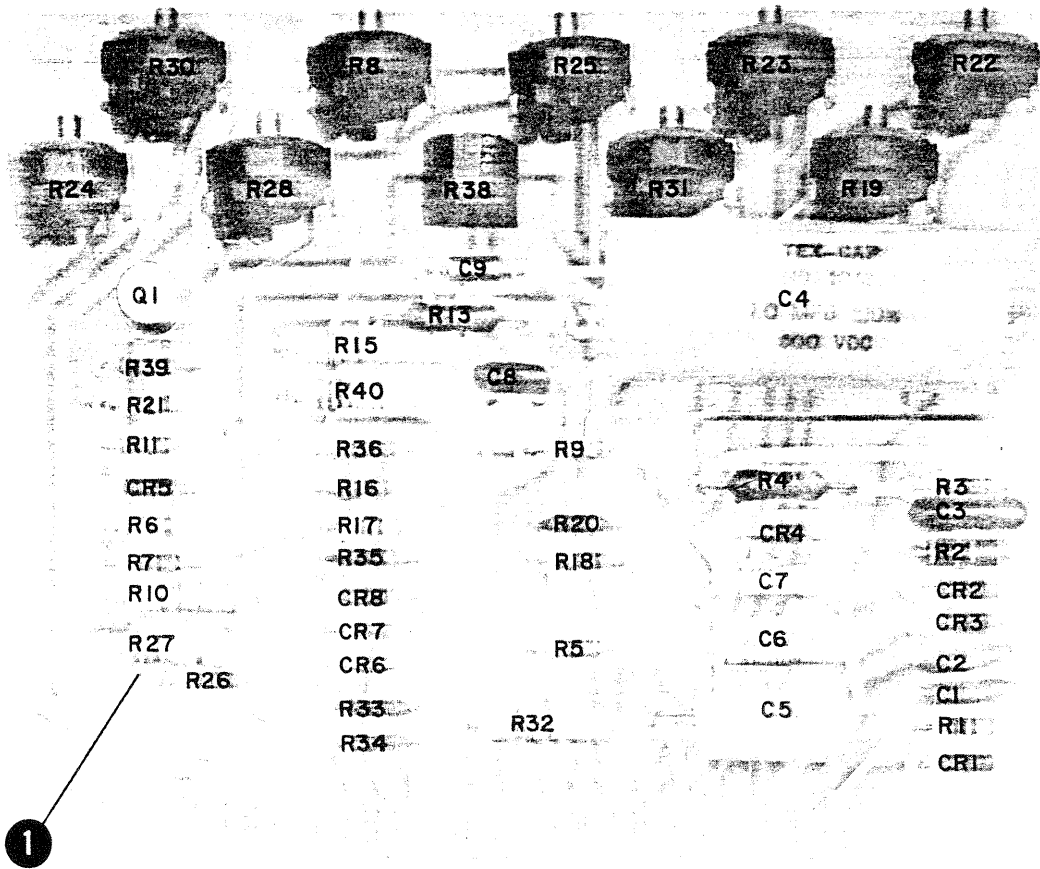
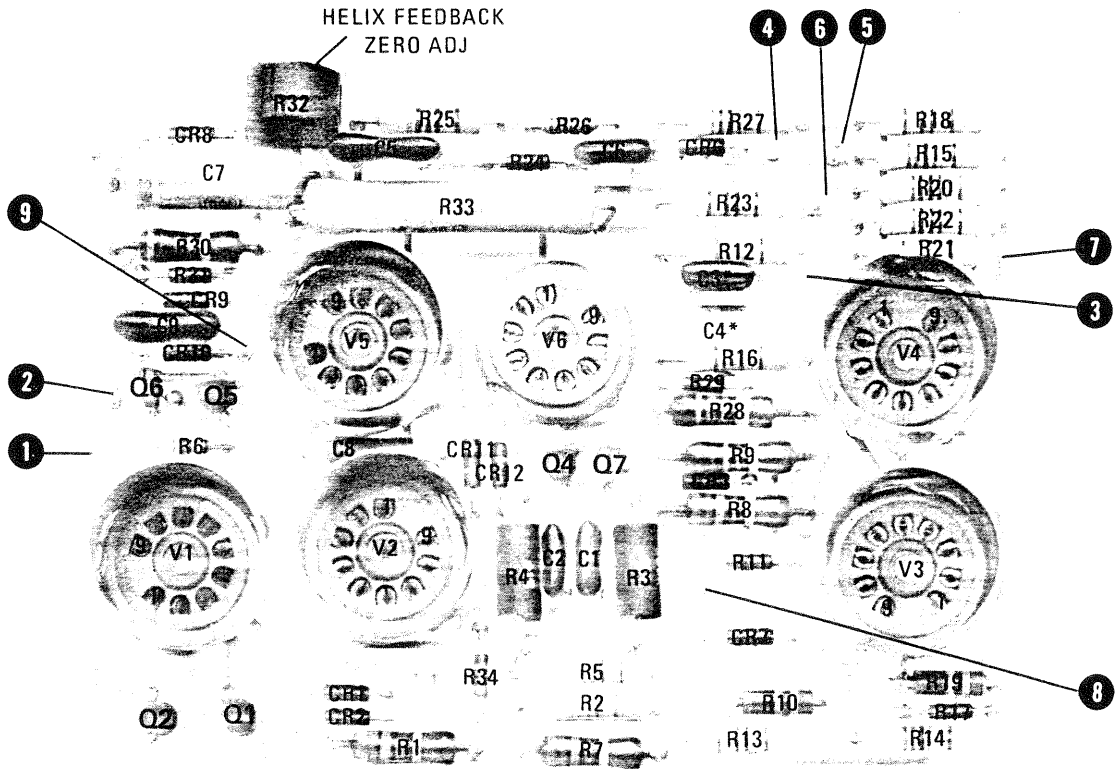

Figure 7-4. FREQUENCY CONTROL SECTION
Tuning Voltage and Marker
Combining (Summing) Circuits

COPYRIGHT 1966 BY HONEYWELL-PACKARD CO.
MILWAUKEE, WIS.



Component Identification, Assembly A2



*FACTORY SELECTED PART MAY BE OMITTED

Component Identification, Assembly A4

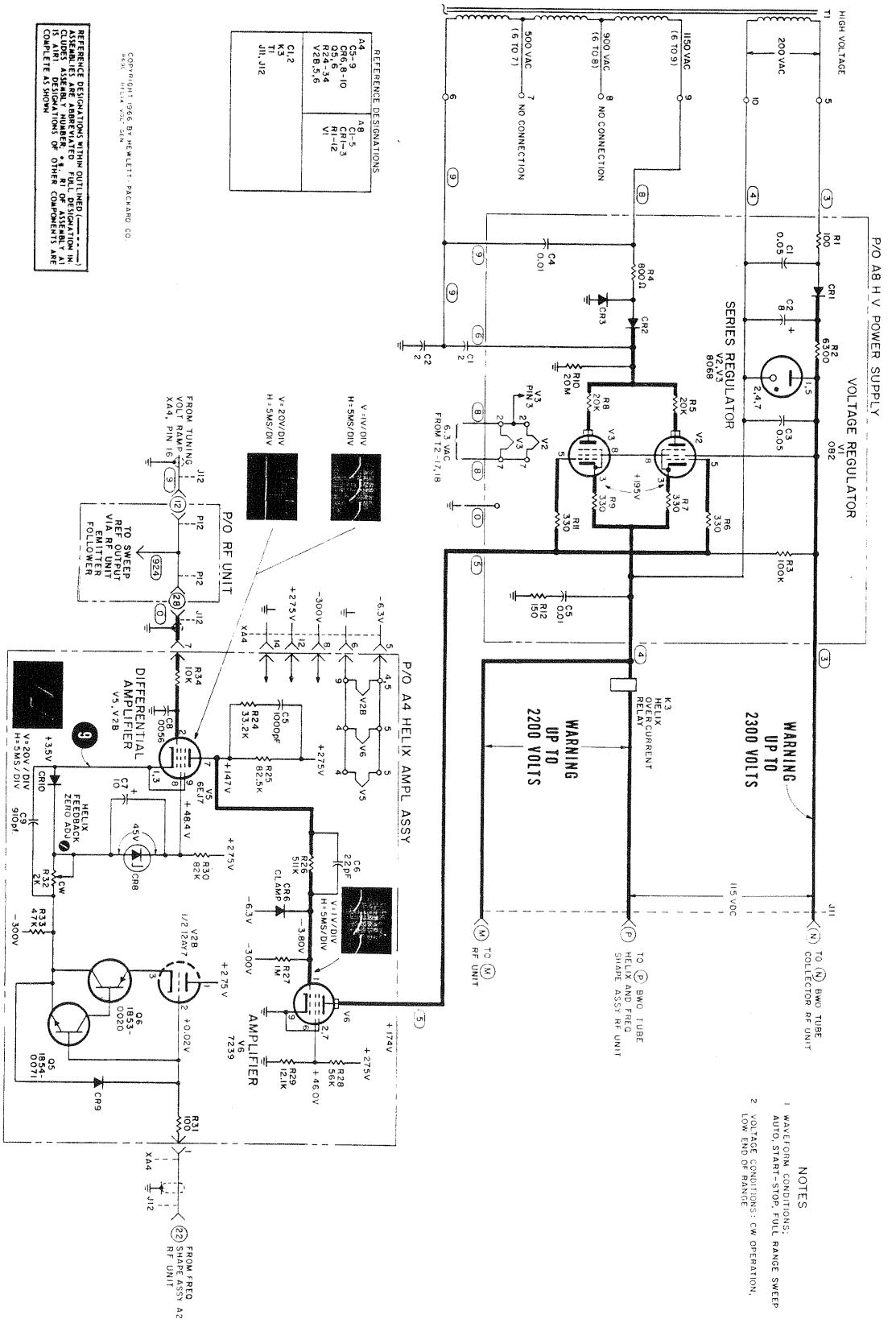
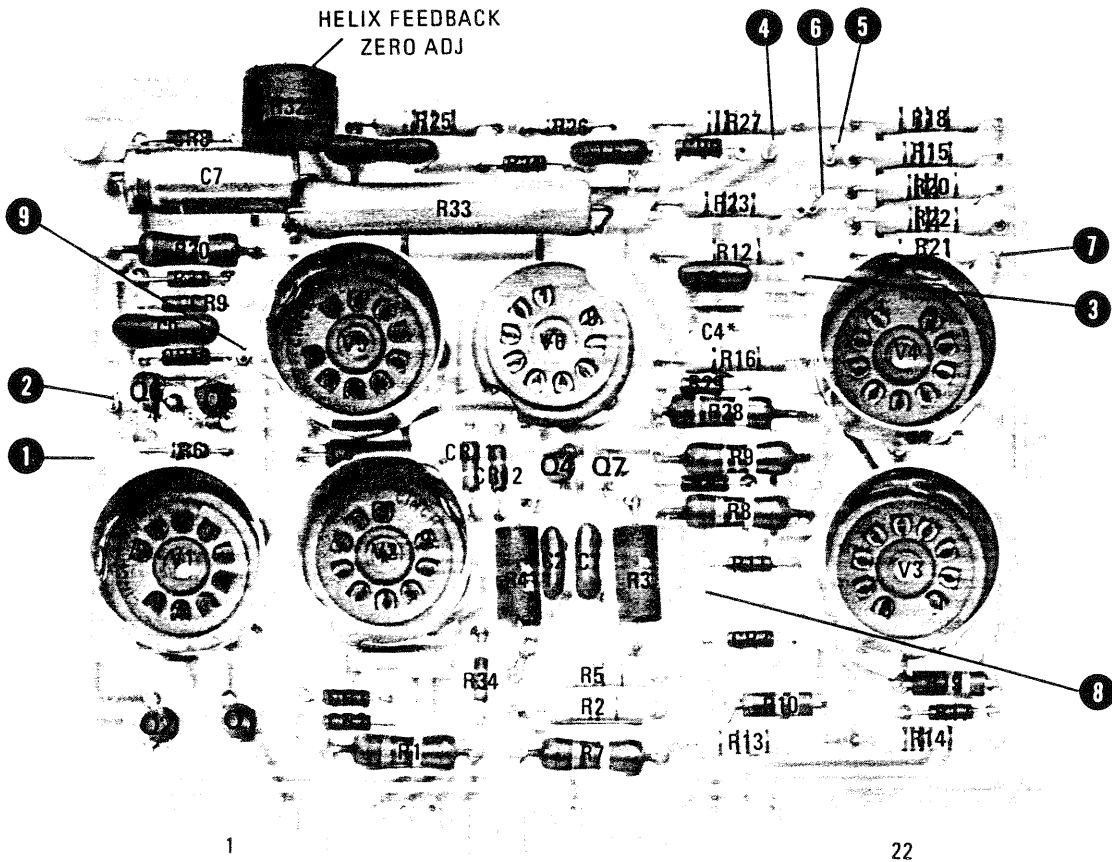

Figure 7-5. FREQUENCY CONTROL SECTION
Helix Voltage Generator

Model 8690B



*FACTORY SELECTED PART, MAY BE OMITTED

Component Identification, Assembly A4

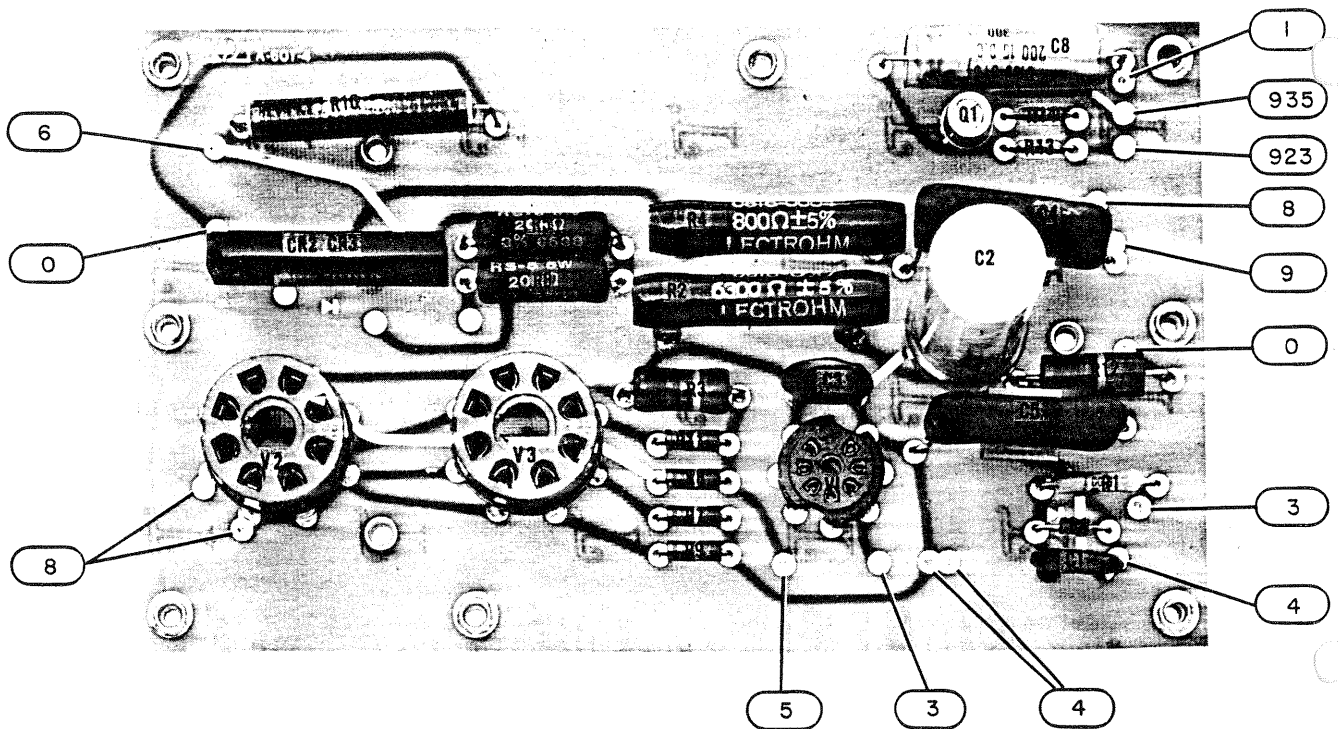

Component Identification, Assembly A8

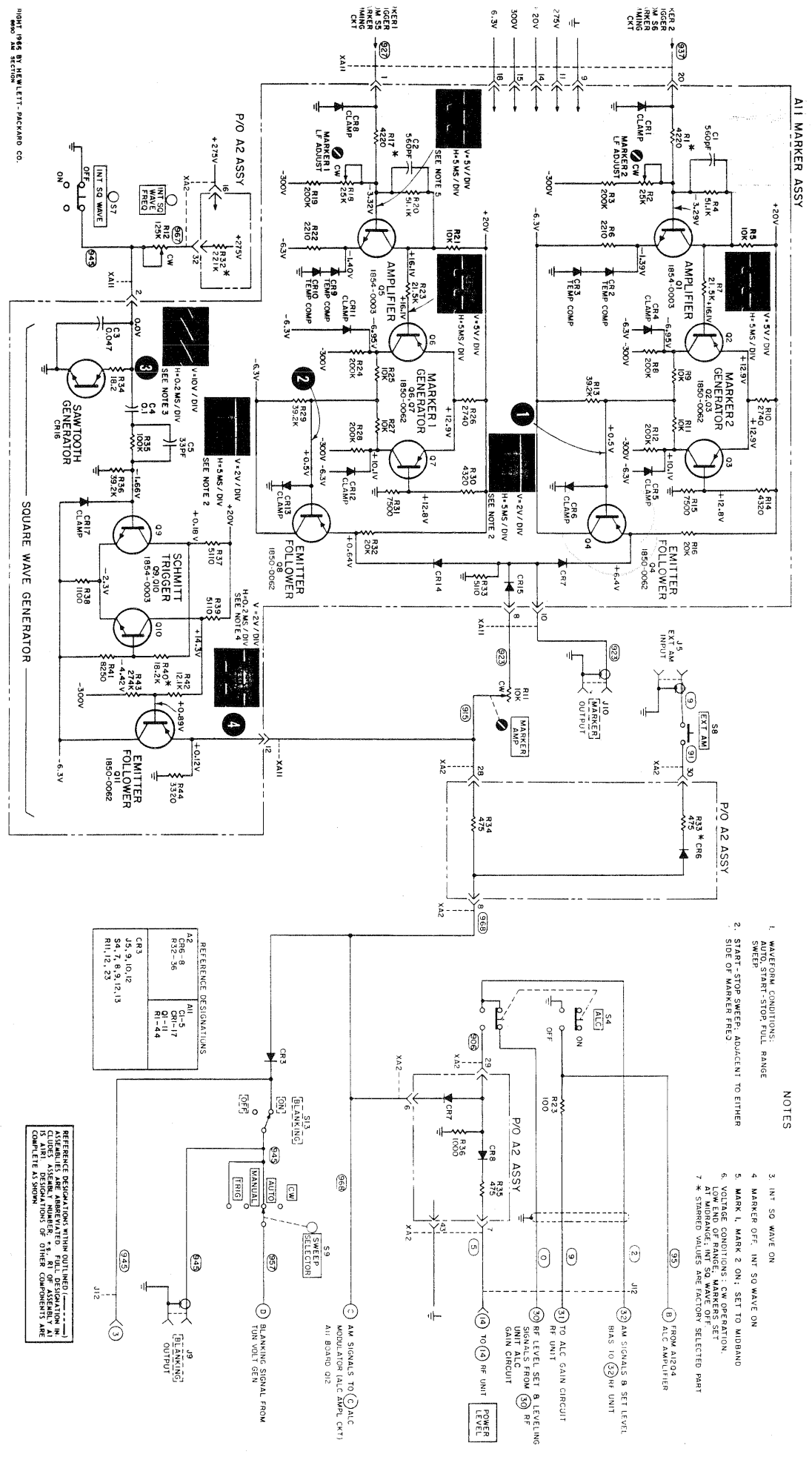

NOTES

1. WAVEFORM CONDITIONS: AUTO, START-STOP FULL RANGE SWEEP
2. START-STOP SWEEP, ADJACENT TO EITHER SIDE OF MARKER FREQ
3. INT SQ WAVE ON
4. MARKER OFF, INT SQ WAVE ON
5. MARK 1, MARK 2 ON; SET TO MIDRANGE
6. VOLTAGE CONDITIONS: CW OPERATION, LOW END OF RANGE, MARKERS SET AT MIDRANGE; INT SQ WAVE OFF
7. * STARRER VALUES ARE FACTORY SELECTED PART

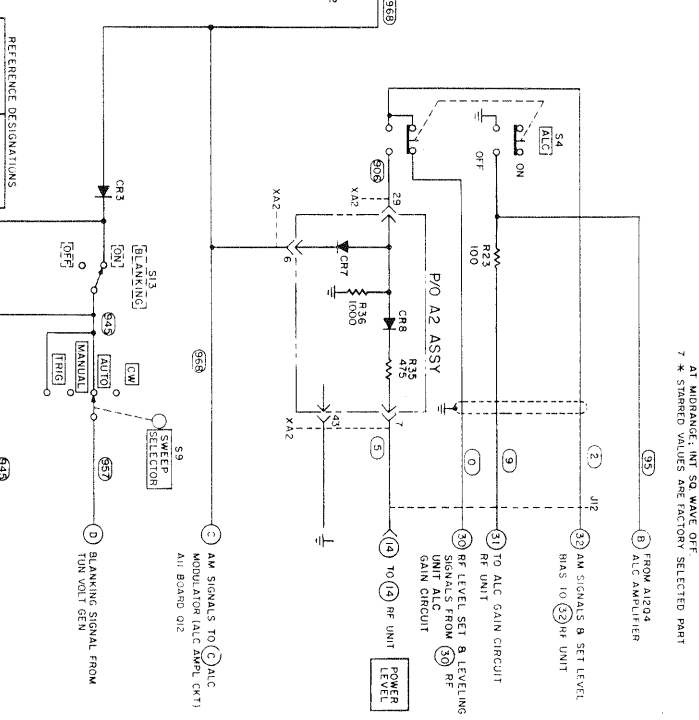
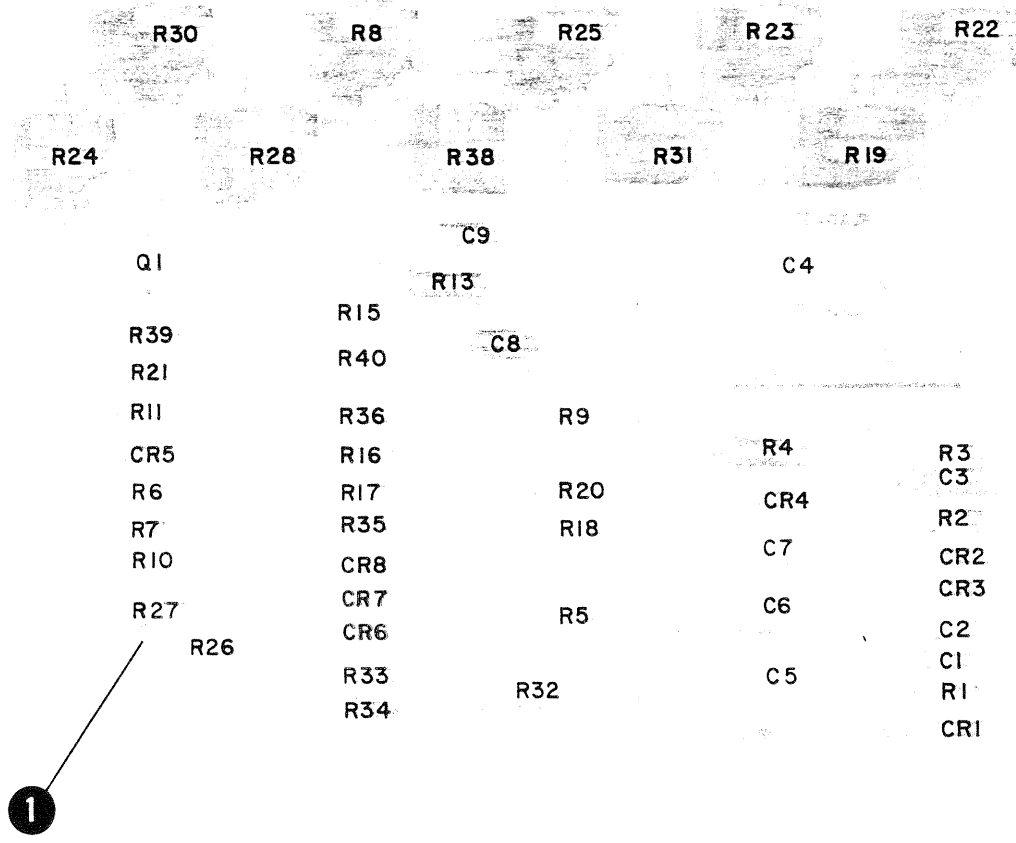

Figure 7-6. AMPLITUDE MODULATION SECTION

RIGHT 1965 BY HUNLETT-PACKARD CO.
RWD:AM SECTION

Model 8690B



Component Identification, Assembly A2

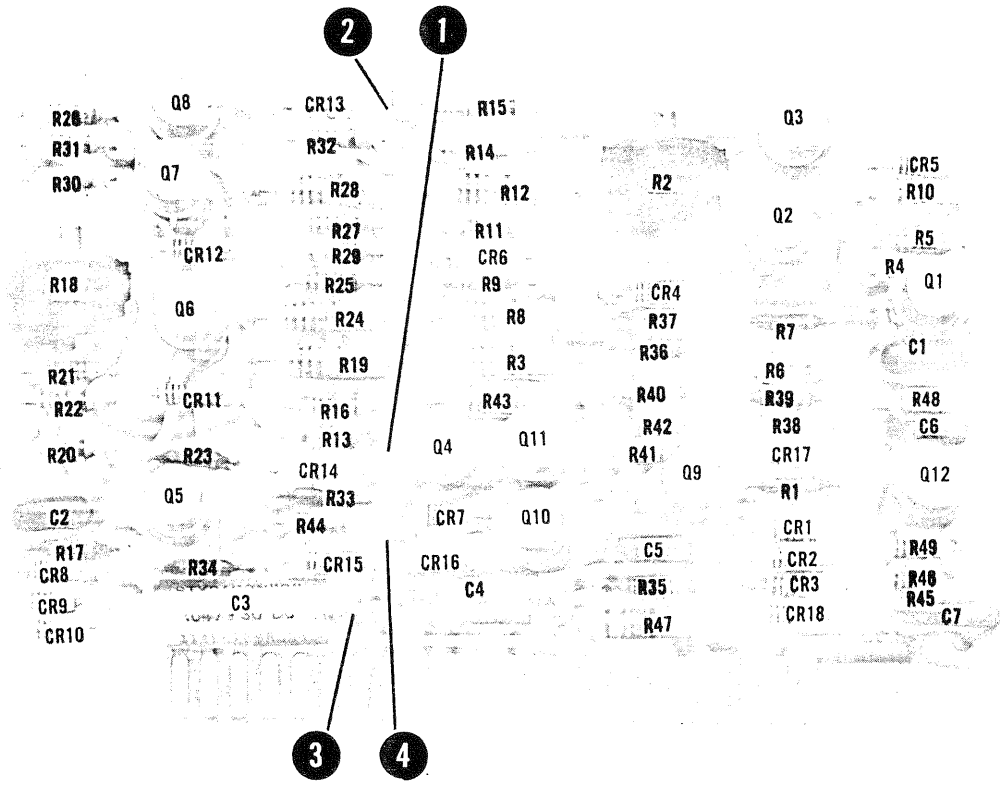

Component Identification, Assembly A11

Model 8690B

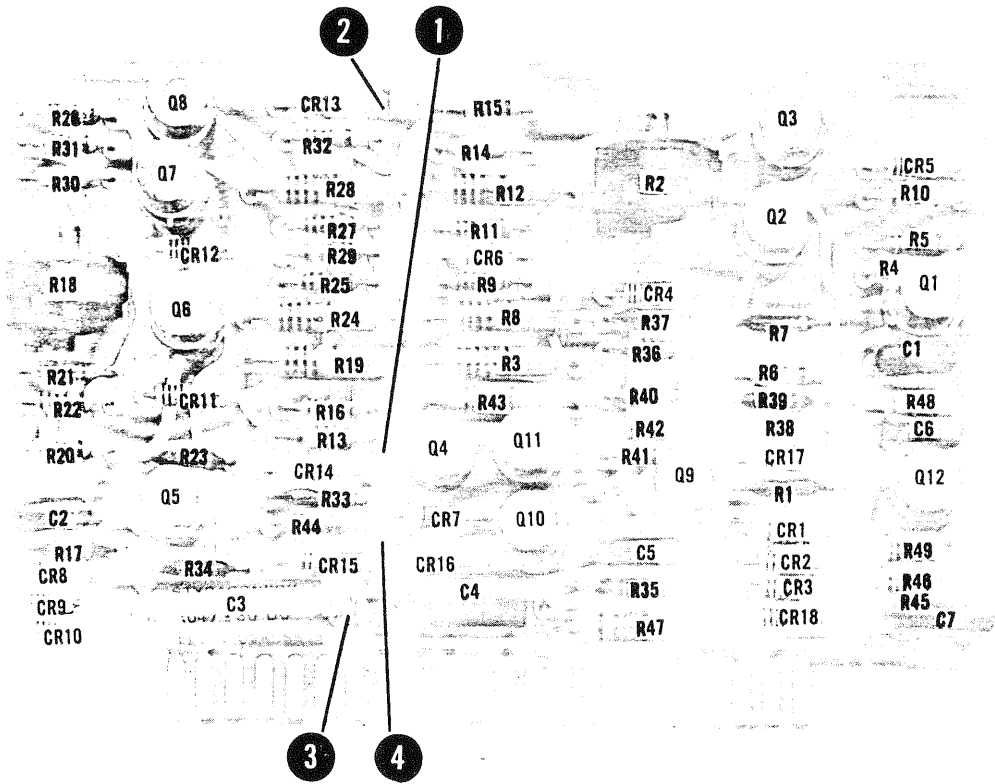

Component Identification, Assembly A11

ALC BALANCE
R7

		VI		Q4
			CI	R16
R10			R5	R8
R9	Q1		R13	CR2
C2			R4	R6
R11	Q2		R14	R3
R15			R12	CR1
C3	Q3		R17	R2
			R18	R1

Component Identification, Assembly A12

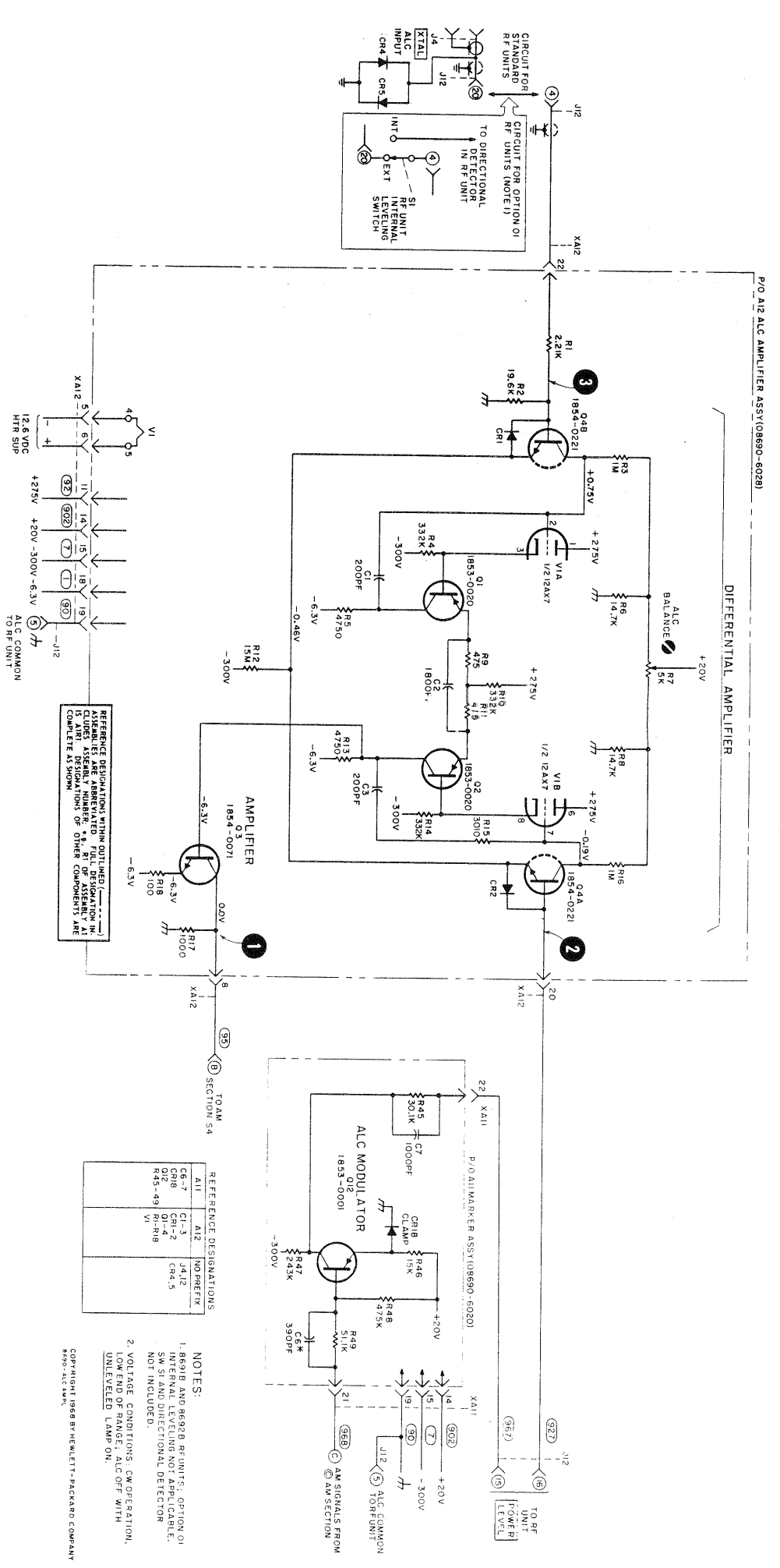

REFERENCE DESIGNATIONS WITHIN DOTTED LINE ARE ASSEMBLY NUMBERS. FULL DESIGNATION IN CIRCLES ARE ABBREVIATED. FULL DESIGNATION IN SQUARES ARE ABBREVIATED. OTHER COMPONENTS ARE COMPLETE AS SHOWN.

REFERENCE DESIGNATIONS		NON-PREFIX	
AI1	AI2	JA12	
CG-7	CI-5	JA12	
Q12	Q1-2	CR4-5	
R45-49	RI-R18	VI	

- NOTES:
- 8691B AND 8692B RF UNITS: OPTION O1 INTERNAL LEVELING NOT APPLICABLE. SO1 AND DETECTION DETECTOR NOT INCLUDED.
 - VOLTAGE CONDITIONS: CW OPERATION, LOW END OF RANGE, ALC OFF WITH UNLEVELLED LAMP ON.

COPYRIGHT 1968 BY HEWLETT-PACKARD COMPANY
8691-41-1000

Figure 7-7. AUTOMATIC LEVEL CONTROL (ALC) AMPLIFIER

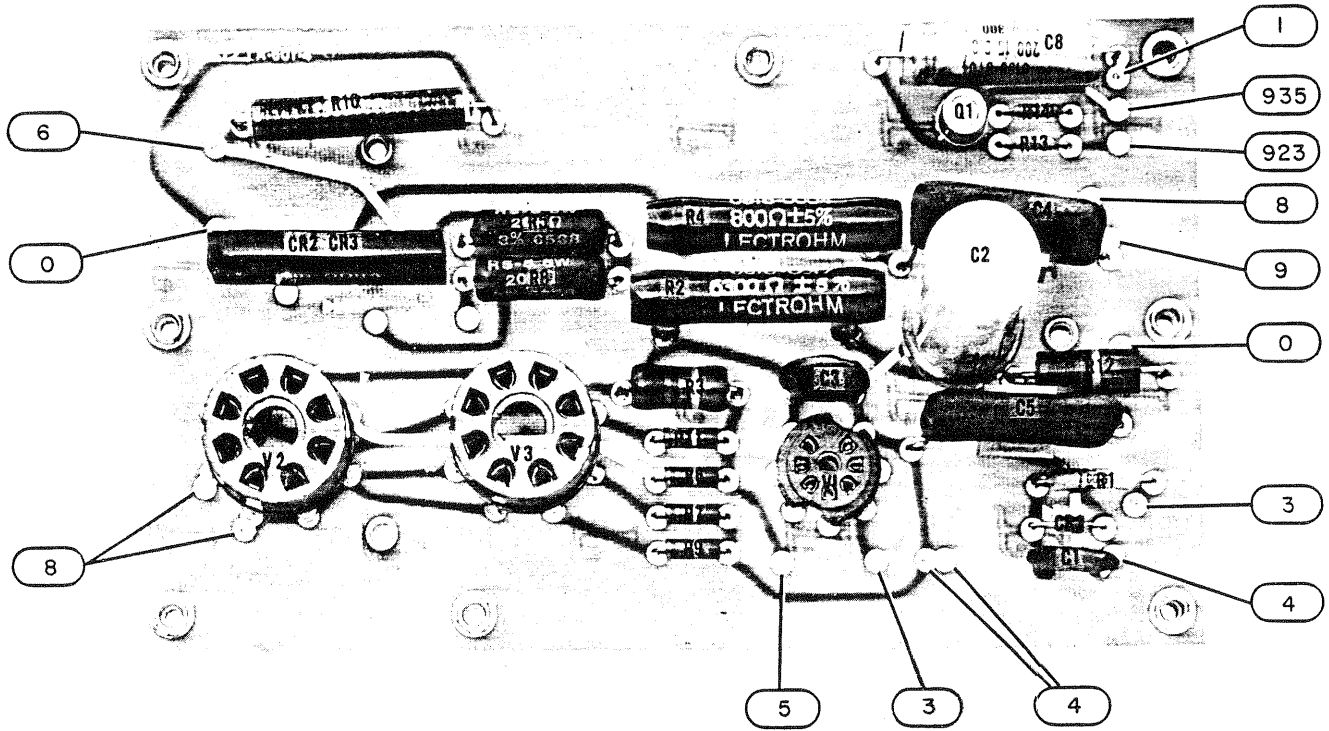

Component Identification, Assembly A8

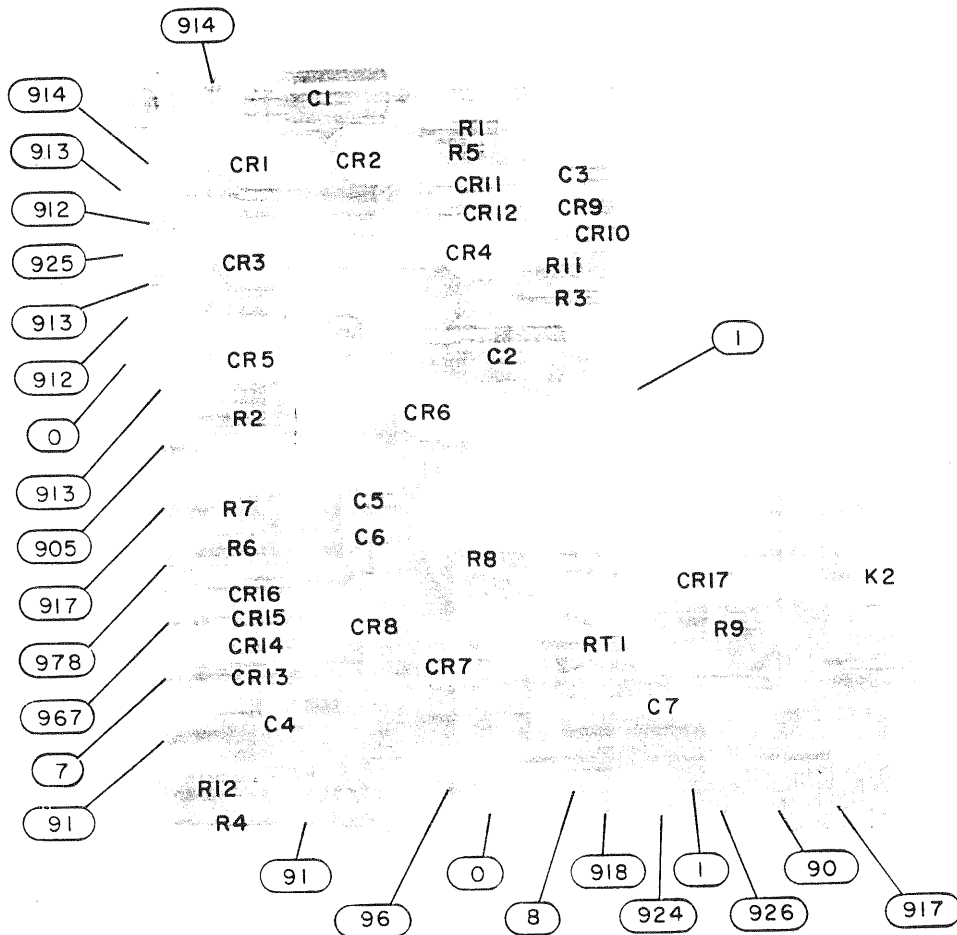

Component Identification, Assembly A9

Model 8690B

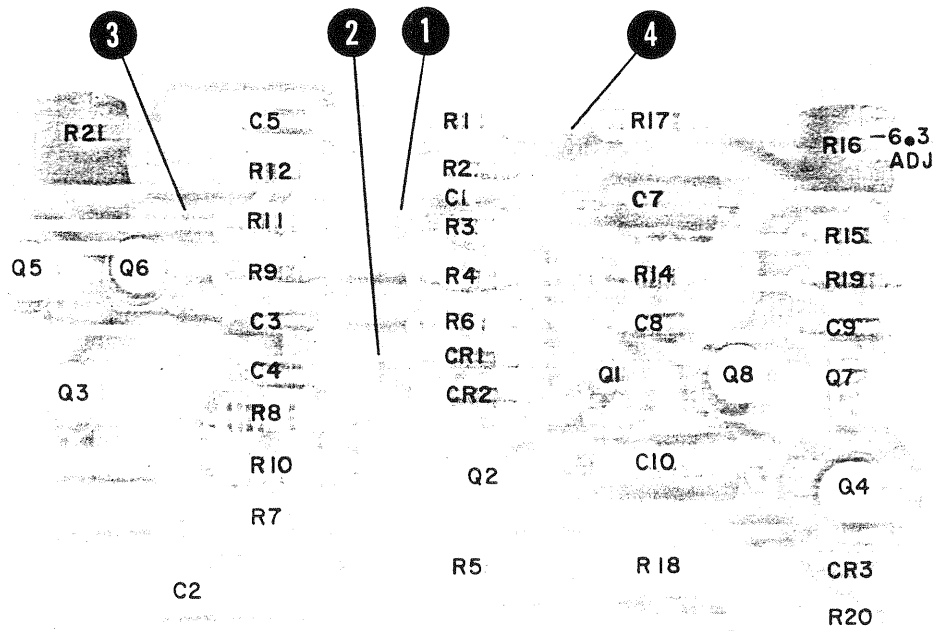

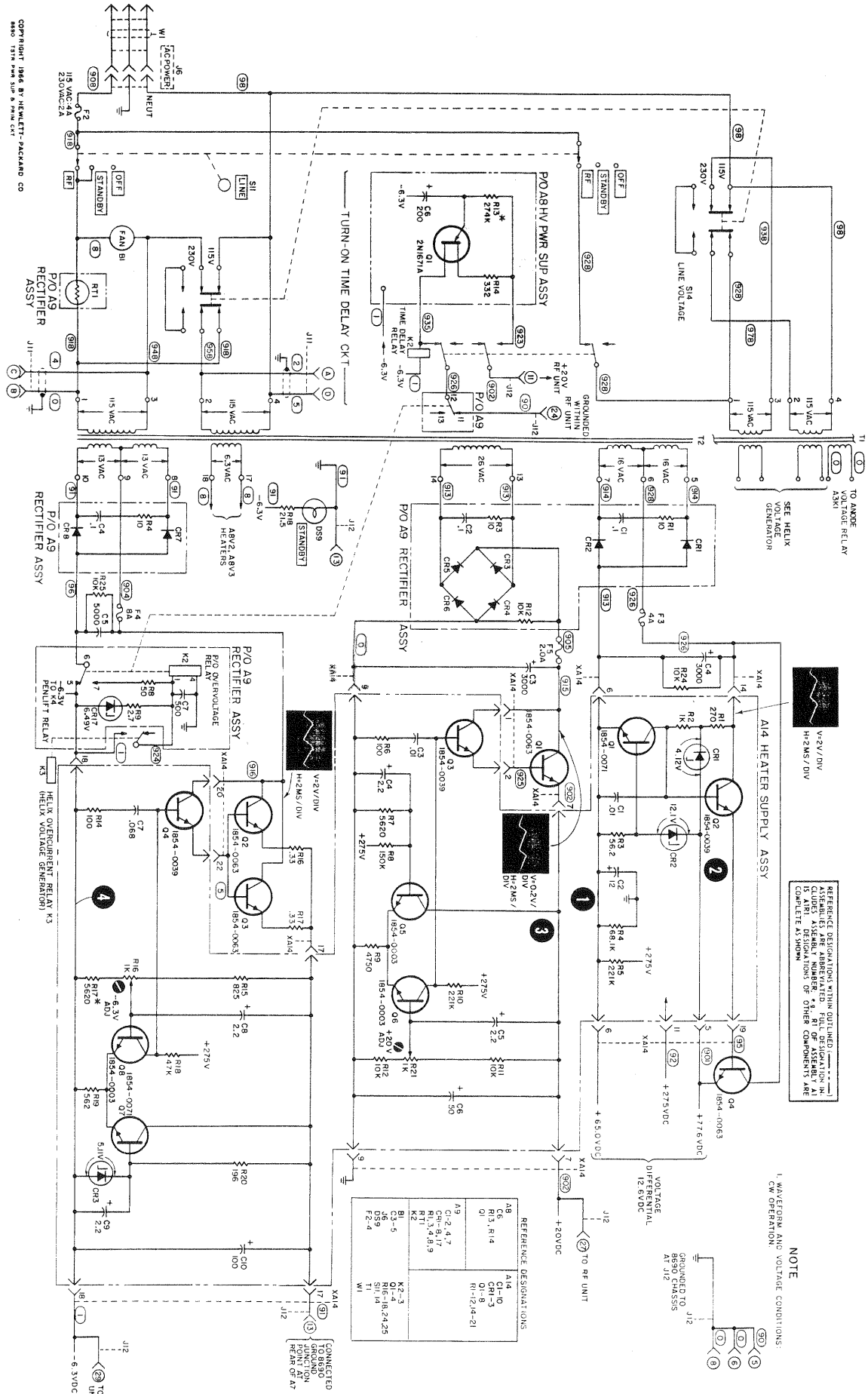
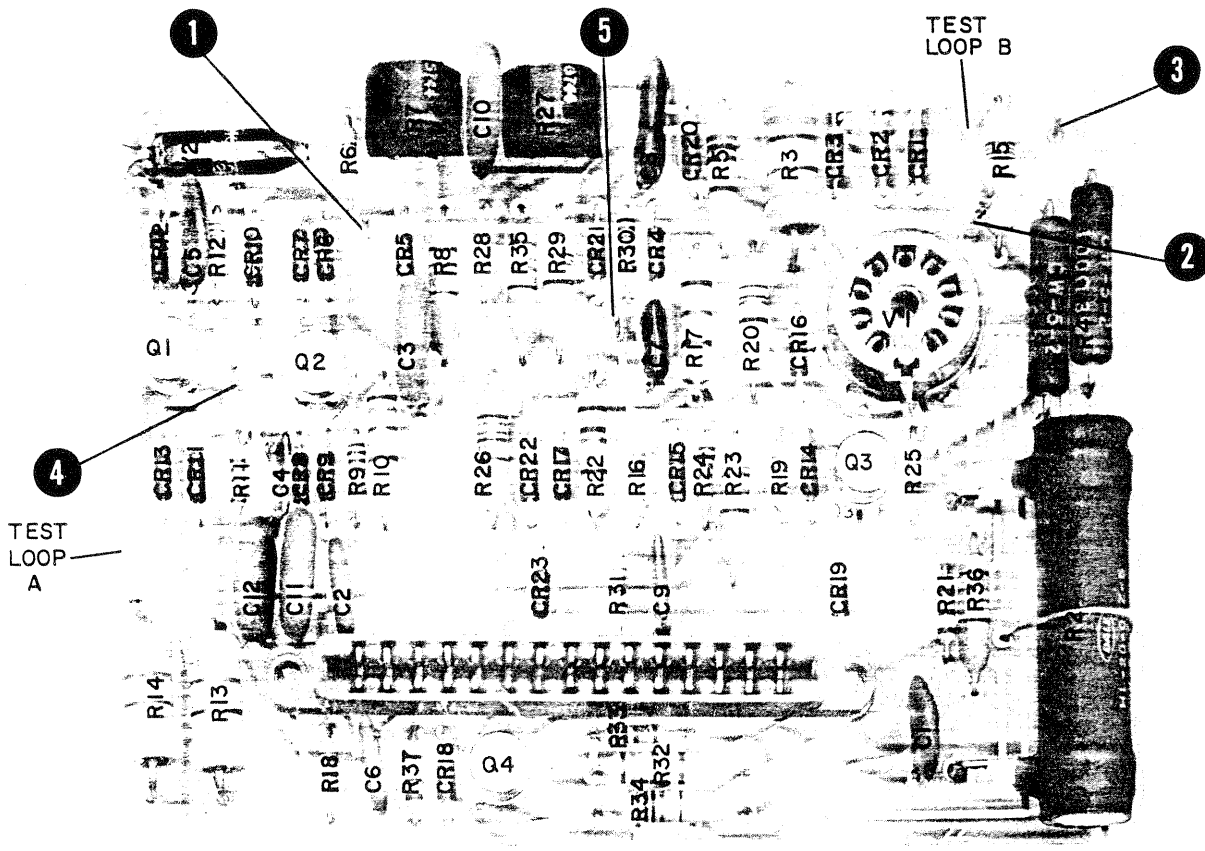
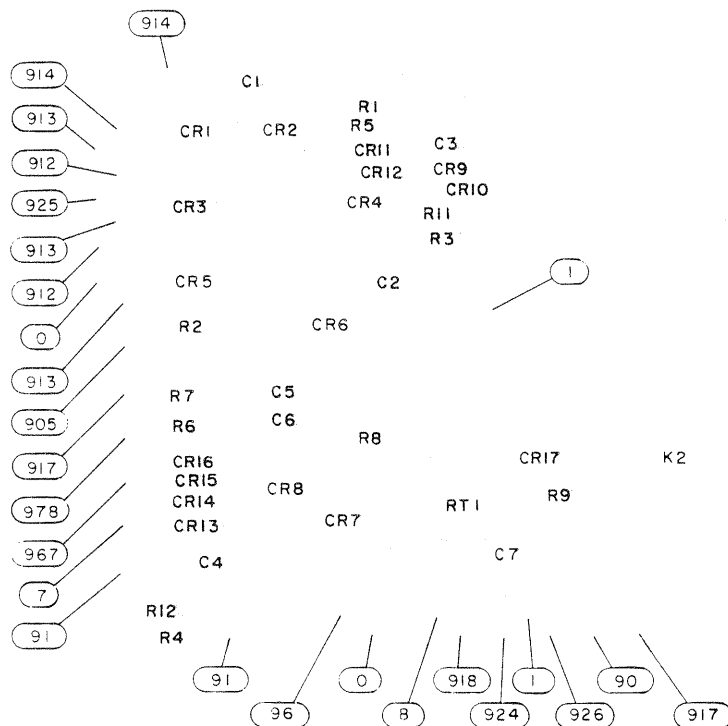

Figure 7-8. POWER SUPPLY SECTION
12.6, -20, and -6.3 Volt Power Supplies
and Primary Power Circuit



Component Identification, Assembly A5



Component Identification, Assembly A9

Section:
Schematic Diagr.

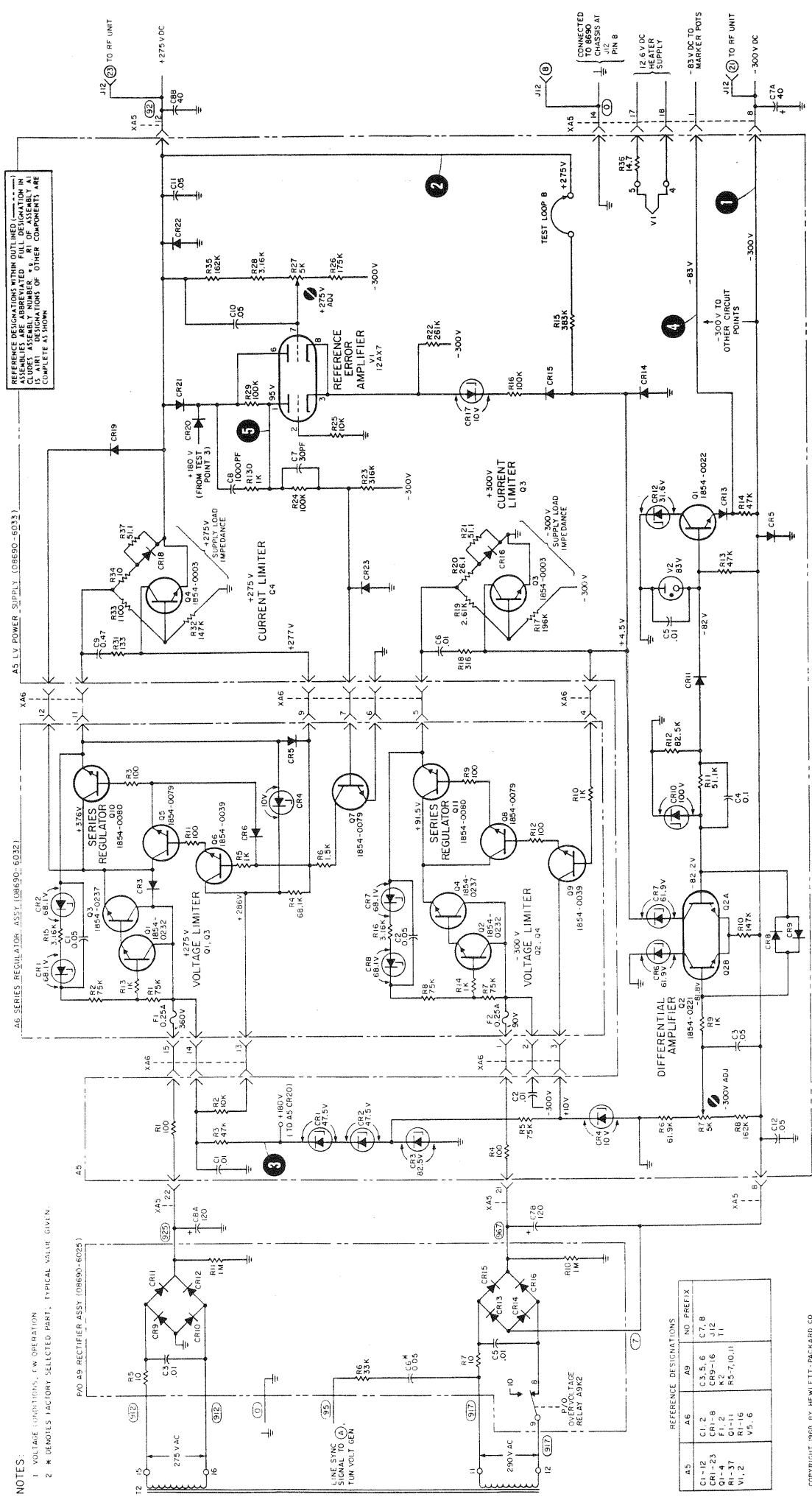

REFERENCE DESIGNATIONS WITHIN OUTLINED ASSEMBLIES ARE ABBREVIATED. FULL DESIGNATION IN PARENTHESES IS TO BE USED FOR ALL PARTS. DESIGNATIONS OF OTHER COMPONENTS ARE COMPLETE AS SHOWN.

NOTES:
1. VOLTAGE LIMITATIONS, F.W. OPERATION
2. * DENOTES FACTORY SELECTED PART; TYPICAL VALUE GIVEN.

REFERENCE DESIGNATIONS	NO. PREFIX
A5	A9
C1-12	C3, 5, 6
C1-23	CR9-16
CR1-8	J12
CR1-4	KS-7, 10, 11
CR1-37	T1
CR1-16	V5, 6

Figure 7-9 POWER SUPPLY SEC 1
+275, -83 and -300 Volt Power Sup

Model 8690B

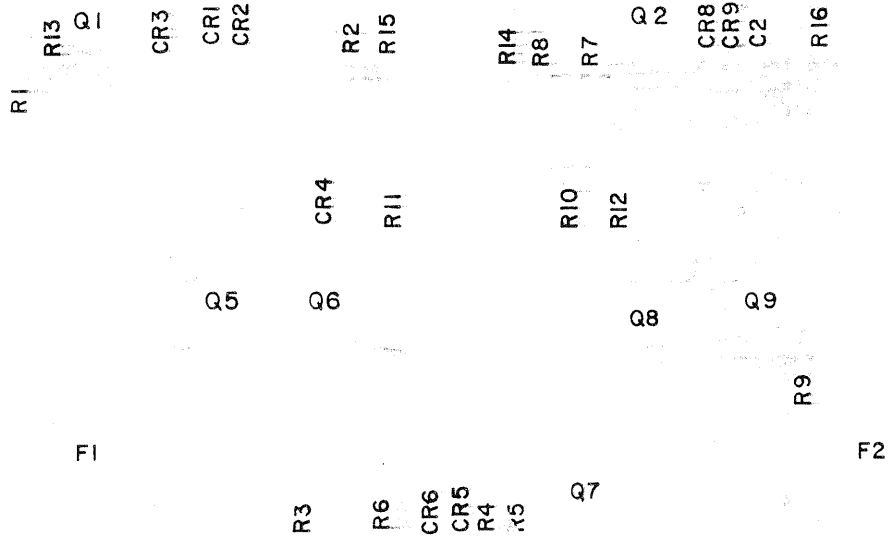

TOP VIEW



BOTTOM VIEW

APPENDIX I
MANUAL CHANGES

1-1. INTRODUCTION

- 1-2. To adapt this manual to instruments with serial numbers prefixed 838, 846, 921, 937, and 959 make the manual changes indicated below.

SERIAL NUMBERS	CHANGE
838-00150 and below	A - J
846-00151 thru 846-00450	A - I
846-00451 thru 846-00650	A - H
846-00651 thru 846-00800	A - G
846-00801 thru 921-01112	A - F
937-00113 thru 937-01200	A - E
937-01201 thru 937-01650	A - D
959-01651 thru 959-01800	A - C
959-01801 thru 959-02070	A, B
959-02071 thru 959-02190	A

- 1-3. Information for adapting this manual to instruments with serial numbers not listed in the table above may be included in a yellow MANUAL CHANGES insert supplied with this manual. Information about serial numbers not covered in any of these ways can be obtained from the nearest Hewlett-Packard office.

CHANGE A:

Page 6-2, Table 6-1 and Figure 7-2.

Change A2C1 to HP Part No. 0150-0012, C: Fxd Cer 0.01 μ f 20% 1000 VDCW.
 Change A2C3 to HP Part No. 0160-2225, C: Fxd Mica 2000pf 5% 300 VDCW.
 Delete A2C10 HP Part No. 0160-2120 C: Fxd Mica 0.01 μ f \pm 1%.

Page 6-10, Table 6-1 and Figure 7-9.

Change A9C6 to HP Part No. 0150-0012 C: Fxd Cer 0.01 μ f 20% 1000 VDCW.

CHANGE B:

Page 6-4, Table 6-1.

Change A3R55 and A3R56 to HP Part No. 0812-0053, same description.

Page 6-6, Table 6-1.

Change A4R3 and A4R4 to HP Part No. 0812-0053, same description.

Page 6-19, Table 6-1.

Change miscellaneous part to HP Part No. 5060-0763, Handle Assy - Side.

CHANGE C:

Page 6-18, Table 6-1.

Add HP Part No. 1450-0152, Lens: Lampholder Red Plastic.
 Delete HP Part No. 1450-0157, Lens: Lampholder, White.
 Delete HP Part No. 1450-0371, Lens: Lampholder, Amber.

CHANGE D:

Page 6-16 and 6-17, Table 6-1.

CHANGE D (continued)

Change J6 to HP Part No. 1251-0148.
Change T1 to HP Part No. 9100-2882.
Change W1 to HP Part No. 8120-0078.

CHANGE E:

Page 6-5, Table 6-1 and Figure 7-4.

Change A4C3 to HP Part No. 0160-2150, 33pf.
Add A4C4 HP Part No. 0160-2150, 33pf.
Show on schematic in parallel with R16. See Figure 2 Component Identification, Assembly A4 of this appendix.

CHANGE F:

Page 6-17, Table 6-1.

Change T1 to HP Part No. 9100-0350.

CHANGE G:

Page 6-5, Table 6-1 and Figure 7-3.

Change A3R63 to HP Part No. 0757-0376, 100K.

Page 6-15, Table 6-1 and Figure 7-8.

Change A14Q3 to HP Part No. 1854-0003 NPN Silicon.

CHANGE H:

Page 5-20 and 5-21, Table 5-4.

Under 10. ΔF Calibration: ΔF Bandwidth:

Change 10. e. to read: Adjust A2R25 ΔF BANDWIDTH ADJ for voltmeter reading change of 7.0 ± 0.2 Vdc.

CHANGE I:

Page 5-17 thru 5-21, Table 5-4.

ADJUSTMENTS, under 1. Power Supply:

Change 1. c. to read: Adjust A5R7 for -300 ± 0.5 Vdc.

Change 1. g. to read: Adjust A5R27 for $+275 \pm 0.3$ Vdc.

Change 1. i. to read: Adjust A14R21 for $+20 \pm 0.2$ Vdc.

Under 2. Sweep Calibration: Ramp Amplitude:

Change 2. d. to read: Adjust A3R75 73V RAMP ADJ for $+73.00 \pm 0.1$ Vdc.

Under 3. Sweep Calibration: Ramp Zero:

Change 3. d. to read: Adjust A3R53 RAMP ZERO ADJ for 0.0 ± 0.1 Vdc.

Under 4. Sweep Calibration: Reciprocal Zero:

Change 4. d. to read: Adjust A3R50 RECIPROCAL ZERO for 0.00 ± 0.4 Vdc.

Under 5. Frequency Control Calibration: Low End:

Change 5. d. to read: Adjust A1R1 START LOW FREQ. ADJ for $+3.0 \pm 0.1$ Vdc.

Change 5. f. to read: Adjust A1R2 MARKER SWEEP START LOW FREQ. ADJ for $+3.0 \pm 0.1$ Vdc.

Change 5. h. to read: Adjust A1R3 MARKER SWEEP STOP LOW FREQ. ADJ for $+3.0 \pm 0.1$ Vdc.

Change 5. j. to read: Adjust A1R4 STOP LOW FREQ. ADJ for $+3.0 \pm 0.4$ Vdc.

Under 6. Helix Feedback Amplifier Gain:

Change 6. d. to read: Adjust A4R32 HELIX FEEDBACK ZERO ADJ for 0 ± 0.1 Vdc.

Under 8. Frequency Control Calibration: High End:

Change 8. d. to read: Adjust A2R24 STOP HF ADJ for $+73.00 \pm 0.1$ Vdc.

Change 8. f. to read: Adjust A2R30 MARKER SWEEP STOP HF ADJ for $+73.00 \pm 0.1$ Vdc.

Change 8. h. to read: Adjust A2R22 MARKER SWEEP START HF ADJ for $+73.00 \pm 0.1$ Vdc.

Change 8. j. to read: Adjust A2R19 ΔF CW ADJ for $+73.00 \pm 0.1$ Vdc.

Under 11. ΔF Calibration: ΔF Center Frequency:

Change 11. d. to read: Set MANUAL SWEEP control for voltmeter reading of $+38.0 \pm 0.1$ Vdc.

Change 11. f. to read: Adjust A2R28 ΔF CENTER ADJ for $+3.00 \pm 0.1$ Vdc.

CHANGE I (continued)

Under 12. ΔF Calibration: ΔF Zero:

Change 12. e. to read: Adjust A2R8 ZERO ΔF ADJ so that voltmeter reading is +3.00 ±0.1 Vdc during step d.

CHANGE J:

Page 6-5, Table 6-1 and on Figure 7-3.

Delete A3R80 and see Figure 1 Component Identification, Assembly A3 of this appendix.

Page 6-7, Table 6-1 and on Figure 7-4.

Change A4V2 to HP Part No. 1932-0049 Electron Tube CK647.

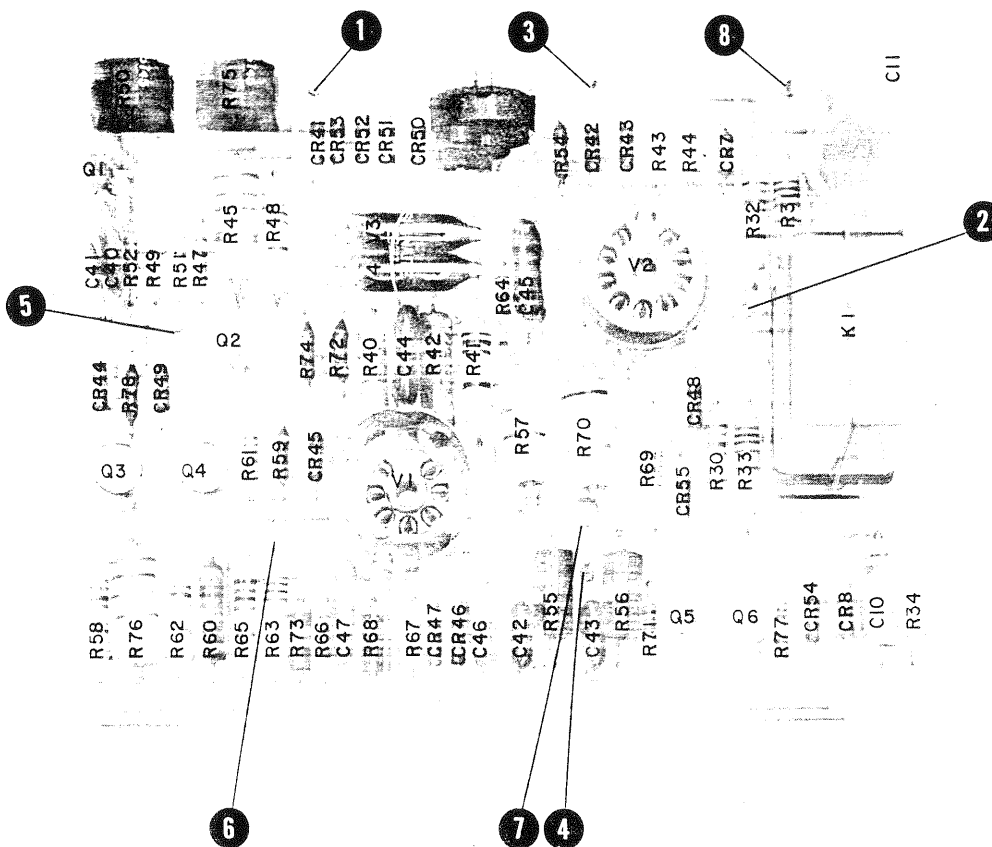

Figure 1. Component Identification, Assembly A3

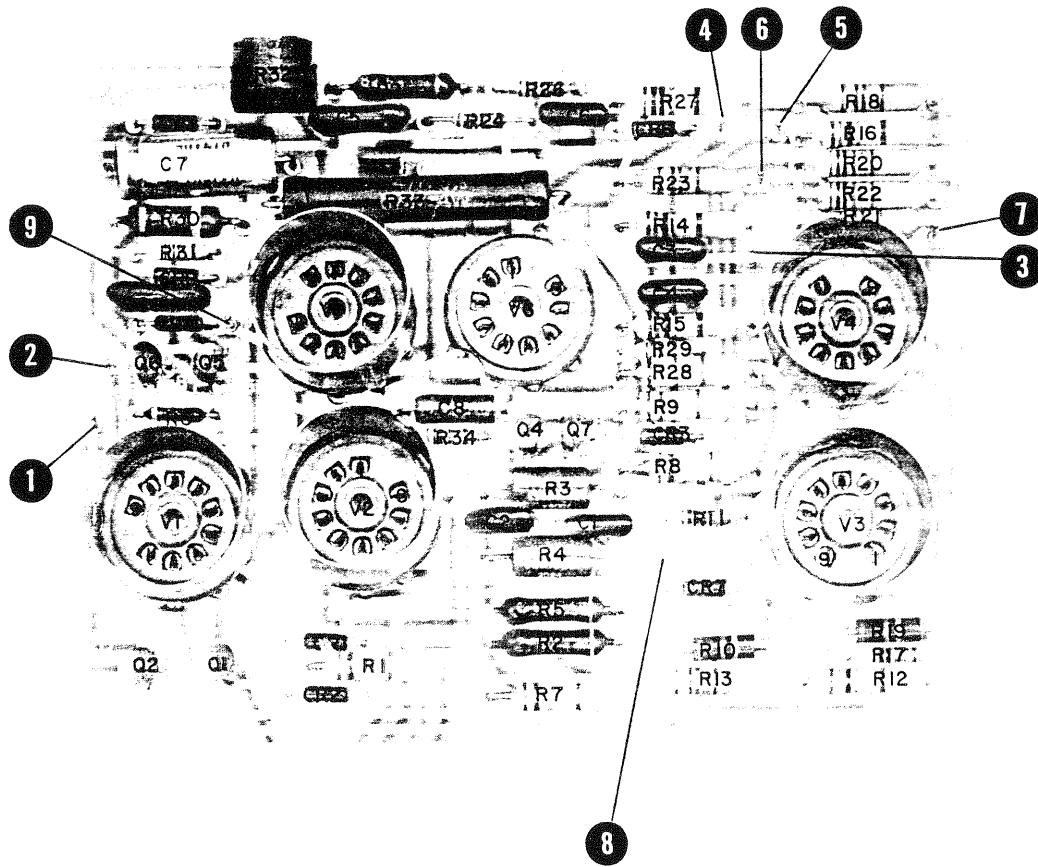

Figure 2. Component Identification. Assembly A4

SALES OFFICES

1



AFRICA, ASIA, AUSTRALIA

ANGOLA
Telectra
Empresa Técnica de Equipamentos
Eléctricos, S.A.R.L.
R. Barbosa Rodrigues, 41-1° DT. °
Caixa Postal, 6487
Luanda
Tel: 35515/6
Cable: TELECTRA Luanda

AUSTRALIA
Hewlett-Packard Australia Pty. Ltd.
31-41 Joseph Street
Blackburn, Victoria 3130
P.O. Box 36

Doncaster East,
Victoria 3109
Tel: 896351
Telex: 31-024
Cable: HEWARD Melbourne

Hewlett-Packard Australia Pty. Ltd.
31 Bridge Street
Pymble

New South Wales, 2073
Tel: 4496566
Telex: 21561
Cable: HEWARD Sydney

Hewlett-Packard Australia Pty. Ltd.
153 Greenhill Road
Parkside, S.A., 5063

Tel: 2725911
Telex: 82536
Cable: HEWARD Adelaide

Hewlett-Packard Australia Pty. Ltd.
141 Stirling Highway
Nedlands, W.A. 6009

Tel: 3865455
Telex: 93859
Cable: HEWARD Perth

Hewlett-Packard Australia Pty. Ltd.
121 Wollongong Street
Fyshwick, A.C.T., 2609

Tel: 804244
Telex: 62650
Cable: HEWARD Canberra

Hewlett-Packard Australia Pty. Ltd.
5th Floor
Teachers Union Building
495-499 Boundary Street
Spring Hill, Queensland
4000

Tel: 2291544
Cable: HEWARD Brisbane

BANGLADESH

The General Electric Co. of
Bangladesh Ltd.
Magnet House 72
Dilkusha Commercial Area
Motijheel, Dacca 2
Tel: 252415, 252419
Telex: 734
Cable: GECDAC Dacca

ETHIOPIA

Abdella Abdulmalik
P.O. Box 2635
Addis Ababa
Tel: 11 93 40

GUAM

Guam Medical Supply, Inc.
Suite C, Airport Plaza
P.O. Box 8947

Tamuning 96911
Tel: 646-4513
Cable: EARMED Guam

HONG KONG

Hewlett-Packard Hong Kong Ltd.
Room 105, Austin Centre
1st Floor
21 Austin Avenue

TST P.O. Box 98524
Kowloon
Tel: 3-697446 (5 lines)

Telex: 36678 HX
Cable: HEWPACK Hong Kong
Medical/Analytical Only
Schmidt & Co. (Hong Kong) Ltd.
Wing On Centre, 28th Floor
Connaught Road, C.

Hong Kong

Tel: 5-455644
Telex: 74766 SCHMX HX

INDIA

Blue Star Ltd.
Sahas
414/2 Vir Savarkar Marg
Prabhadevi

Bombay 400 025
Tel: 45 78 87
Telex: 011-4093

Cable: FROSTBLUE
Blue Star Ltd.
Band Box House
Prabhadevi

Bombay 400 025
Tel: 45 73 01
Telex: 011-3751

Cable: BLUESTAR
Blue Star Ltd.
Bhavdeop
Stadium Road

Ahmedabad 380 014
Tel: 43922
Telex: 012-234

Cable: BLUEFROST
Blue Star Ltd.
7 Hare Street
Calcutta 700 001

Tel: 23-0131
Telex: 021-7655

Cable: BLUESTAR
Blue Star Ltd.
Bhandari House
91 Nehru Place

New Delhi 110 024
Tel: 682547
Telex: 031-2463

Cable: BLUESTAR
Blue Star Ltd.
T.C. 7/603 'Poornima'
Maruthankuzhi

Trivandrum 695 013
Tel: 65799
Telex: 0884-259

Cable: BLUESTAR
Blue Star Ltd.
11 Magarath Road
Bangalore 560 025

Tel: 55668
Telex: 0845-430

Cable: BLUESTAR
Blue Star Ltd.
Meeakshi Mandiram
XXXXV/1379-2 Mahatma
Gandhi Rd.

Cochin 682 016
Tel: 32069
Telex: 085-514

Cable: BLUESTAR
Blue Star Ltd.
1-1-117/1 Sarojini Devi Road
Secunderabad 500 033

Tel: 70126
Telex: 0155-459

Cable: BLUESTAR

Blue Star Ltd.
133 Kodambakkam High Road
Madras 600 034

Tel: 82057
Telex: 041-379
Cable: BLUESTAR

INDONESIA

BERCA Indonesia P.T.
P.O. Box 496/Jkt.
Jln. Abdul Muis 62

Jakarta
Tel: 349255, 349886
Telex: 46748 BERSIL IA

Cable: BERSAL
BERCA Indonesia P.T.
P.O. Box 174/Sby.

23 Jln. Jimerto
Surabaya
Tel: 42027
Cable: BERCACON

JAPAN

Yokogawa-Hewlett-Packard Ltd.
29-21, Takaido-Higashi 3-chome
Suginami-ku, **Tokyo** 168

Tel: 03-331-6111
Telex: 232-2024 YHP-Tokyo
Cable: YHPMARKET TOK 23 724

Yokogawa-Hewlett-Packard Ltd.
Chuo Bldg., 4th Floor
4-20, Nishinakajima 5-chome

Yodogawa-ku, Osaka-shi
Osaka, 532
Tel: 06-304-6021
Telex: 523-3624

Yokogawa-Hewlett-Packard Ltd.
Sunimoto Seimei Nagaya Bldg.
11-2 Shimosasajima-cho,
Nakamura-ku, **Nagoya**, 450

Tel: 052-571-5171
Yokogawa-Hewlett-Packard Ltd.
Tanigawa Building

2-24-1 Tsuruya-cho
Kanagawa-ku
Yokohama, 221

Tel: 045-312-1252
Telex: 382-3204 YHP YOK

Yokogawa-Hewlett-Packard Ltd.
Mito Mitsui Building
105, 1-chome, San-no-maru

Mito, Ibaragi 310
Tel: 0292-25-7470

Yokogawa-Hewlett-Packard Ltd.
Inoue Building
1348-3, Asahi-cho, 1-chome

Atsugi, Kanagawa 243
Tel: 0462-24-0452

Yokogawa-Hewlett-Packard Ltd.
Kumagaya Asahi
Hachijuni Building
4th Floor

3-4, Tsukuba
Kumagaya, Saitama 360
Tel: 0485-24-6563

KENYA

ADCOM Ltd., Inc.
P.O. Box 30070
Nairobi

Tel: 331955
Telex: 22639
Medical Only
International Aeradio (E.A.) Ltd.

P.O. Box 19012
Nairobi Airport
Nairobi
Tel: 336055/56

Telex: 22201/22301
Cable: INTAERIO Nairobi

Medical Only
International Aeradio (E.A.) Ltd.
P.O. Box 95221

Mombasa
KOREA
Samsung Electronics Co., Ltd.

22nd Floor Dongbang Bldg.,
250, 2-KA, Taepyung-Ro
Chung-Ku,
Seoul
Tel: 777-4886

Telex: SAMSAN 27364

MALAYSIA

Hewlett-Packard Sales
(Malaysia) Sdn. Bhd.
Suite 2.21/2.22
Bangunan Angkasa Raya
Jalan Ampang

Kuala Lumpur
Tel: 483680, 485653

Protel Engineering
P.O. Box 1917
Lot 259, Satok Road
Kuching, **Sarawak**
Tel: 53544

Cable: PROTELENG
MOZAMBIQUE
A.N. Goncalves, Ltd.
162, 1° Apt. 14 Av. D. Luis
Caixa Postal 107

Maputo
Tel: 27091, 27114
Telex: 6-203 NEGON Mo
Cable: NEGON

NEW GUINEA

Hewlett-Packard Australia Pty. Ltd.
Development Bank Building
Ground Floor
Ward Strip
Port Moresby, Papua
Tel: 258933

NEW ZEALAND

Hewlett-Packard (N.Z.) Ltd.
4-12 Crucksank Street
Kilbirnie, Wellington 3
P.O. Box 9443

Courteney Place
Wellington
Tel: 877-199

Cable: HEWPACK Wellington
Hewlett-Packard (N.Z.) Ltd.
P.O. Box 26-189

169 Manukau Road
Epsom, **Auckland**
Tel: 687-159

Cable: HEWPACK Auckland
Analytical, Medical Only
Northrop Instruments &
Systems Ltd.

Sturdee House
85-87 Ghuznee Street
P.O. Box 2406
Wellington
Tel: 850-091

Telex: NZ 31291
Northrop Instruments &
Systems Ltd.
Eden House, 44 Khyber Pass Rd.
P.O. Box 9682, Newmarket

Auckland 1
Tel: 794-091

Northrop Instruments &
Systems Ltd.
Terrace House, 4 Oxford Terrace
P.O. Box 8388
Christchurch
Tel: 64-165

NIGERIA

The Electronics
Instrumentations Ltd.
N6B/770 Oyo Road
Oluseun House
P.M.B. 5402

Ibadan
Tel: 461577
Telex: 31231 TEIL NG
Cable: THETIEL Ibadan

The Electronics
Instrumentations Ltd.
144 Agege Motor Road, Mushin
P.O. Box 481

Mushin, Lagos
Cable: THETIEL Lagos

PAKISTAN

Mushko & Company Ltd.
Oosman Chambers
Abdullah Haroon Road
Karachi-3
Tel: 511027, 512927

Telex: 2894
Cable: COOPERATOR Karachi
Mushko & Company, Ltd.
10, Bazar Rd.
Sector G-6/4

Islamabad
Tel: 28264
Cable: FEMUS Rawalpindi

PHILIPPINES

The Online Advanced Systems
Corporation
Rico House
Amorsolo cor. Herrera Str.

Legaspi Village, Makati
P.O. Box 1510
Metro Manila
Tel: 85-35-81, 85-34-91, 85-32-21

Telex: 3274 ONLINE

RHODESIA

Field Technical Sales
45 Kelvin Road North
P.O. Box 3458

Salisbury
Tel: 705231 (5 lines)
Telex: RH 4122

SINGAPORE

Hewlett-Packard Singapore
(Pte.) Ltd.
1150 Depot Road
P.O. Box 58
Alexandra Post Office
Singapore 3
Tel: 270-2355

Telex: HPSG RS 21486
Cable: HEWPACK, Singapore

SOUTH AFRICA

Hewlett-Packard South Africa
(Pty.) Ltd.
Private Bag Wendywood,
Sandton, Transvaal, 2144
Hewlett-Packard Centre
Daphne Street, Wendywood,
Sandton, 2144

Tel: 802-5111/25
Telex: 8-4782
Cable: HEWPACK Johannesburg
Hewlett-Packard South Africa
(Pty.) Ltd.

P.O. Box 120
Howard Place,
Cape Province, 7450
Pine Park Centre, Forest Drive,
Pinelands,
Cape Province, 7405

Tel: 53-7955 thru 9
Telex: 57-0006

SRI LANKA

Metropolitan Agencies Ltd.
209/9 Union Place
Colombo 2
Tel: 35947

Telex: 1377METRO LTD CE
Cable: METRO LTD

SUDAN

Radison Trade
P.O. Box 921
Khartoum
Tel: 44048
Telex: 375

TAIWAN

Hewlett-Packard Far East Ltd.
Taiwan Branch
Bank Tower, 5th Floor
205 Tun Hsu North Road

Taipei
Tel: (02) 751-0404 (15 lines)
Cable: HEWPACK TAIPEI

Hewlett-Packard Far East Ltd.
Taiwan Branch
68-2, Chung Cheng 3rd. Road

Kaohsiung
Tel: (07) 242318-Kaohsiung
Analytical Only
San Kwang Instruments Co., Ltd.

20 Xung Sui Road
Taipei
Tel: 3615446-9 (4 lines)

Telex: 22894 SANKWANG
Cable: SANKWANG Taipei

TANZANIA

Medical Only
International Aeradio (E.A.) Ltd.
P.O. Box 861
Dar es Salaam
Tel: 21251 Ext. 265

Telex: 41030

THAILAND

UNIMESA Co. Ltd.
Elcom Research Building
2538 Sukumvit Ave.
Bangchak, Bangkok

Tel: 3932387, 3930338
Cable: UNIMESA Bangkok

ZAMBIA

R.J. Tilbury (Zambia) Ltd.
P.O. Box 2792
Lusaka
Tel: 73793

Cable: ARJAYTEE, Lusaka

OTHER AREAS NOT LISTED, CONTACT:

Hewlett-Packard Intercontinental
3495 Deer Creek Road
Palo Alto, California 94304

Tel: (415) 856-1501
TWX: 910-373-1267

Cable: HEWPACK Palo Alto
Telex: 034-8300, 034-8493

SALES OFFICES

(cont.)

CANADA

ALBERTA

Hewlett-Packard (Canada) Ltd.
11620A - 168th Street
Edmonton T5M 3T9
Tel: (403) 452-3670
TWX: 610-831-2431

Hewlett-Packard (Canada) Ltd.
210, 7220 Fisher St. S.E.
Calgary T2H 2H8
Tel: (403) 253-2713
TWX: 610-821-6141

BRITISH COLUMBIA

Hewlett-Packard (Canada) Ltd.
10691 Shellbridge Way
Richmond V6X 2W7
Tel: (604) 270-2277
TWX: 610-925-5059

MANITOBA

Hewlett-Packard (Canada) Ltd.
380-550 Century St.
St. James,
Winnipeg R3H 0Y1
Tel: (204) 786-6701
TWX: 610-671-3531

NOVA SCOTIA

Hewlett-Packard (Canada) Ltd.
P.O. Box 931
800 Windmill Road
Dartmouth B3B 1L1
Tel: (902) 469-7820
TWX: 610-271-4482

ONTARIO

Hewlett-Packard (Canada) Ltd.
1020 Morrison Dr.
Ottawa K2H 8K7
Tel: (613) 820-6483
TWX: 610-563-1636

Hewlett-Packard (Canada) Ltd.
6877 Goreway Drive
Mississauga L4V 1M8
Tel: (416) 678-9430
TWX: 610-492-4246

Hewlett-Packard (Canada) Ltd.
552 Newbold Street
London N6E 2S5
Tel: (519) 686-9181
TWX: 610-352-1201

QUEBEC

Hewlett-Packard (Canada) Ltd.
275 Hymus Blvd.
Pointe Claire H9R 1G7
Tel: (514) 697-4232
TWX: 610-422-3022

FOR CANADIAN

AREAS NOT

LISTED:
Contact Hewlett-Packard (Canada)
Ltd. in Mississauga.

CENTRAL, SOUTH AMERICA

ARGENTINA

Hewlett-Packard Argentina S.A.
Santa Fe 2035, Martinez
6140 **Buenos Aires**
Tel: 792-1239, 798-6086
Telex: 122443 AR CIGY
Cable: HEWPACKARG
Biotron S.A.C.I.y.M.
Avda. Paseo Colon 221
9 piso
1399 **Buenos Aires**
Tel: 30-4846 / 1851 / 8384
34-9356 / 0460 / 4551
Telex: (33) 17595 BIO AR
Cable: BIOTRON Argentina

BRAZIL

Hewlett-Packard do Brasil
I.e.C. Ltda.
Alameda Rio Negro, 750
Alphaville
06400 **Barueri** SP
Tel: 429-3222
Cable: HEWPACK São Paulo
Hewlett-Packard do Brasil
I.e.C. Ltda.
Rua Padre Chagas, 32
90000-**Pôrto Alegre**-RS
Tel: 22-2998, 22-5621
Cable: HEWPACK Pôrto Alegre
Hewlett-Packard do Brasil
I.e.C. Ltda.
Av. Epitácio Pessoa, 4664
22471-**Rio de Janeiro**-RJ
Tel: 286-0237
Telex: 021-21905 HPBR-BR
Cable: HEWPACK Rio de Janeiro

CHILE

Jorge Calcagni y Cia. Ltda.
Arturo Buriel 065
Casilla 16475
Correo 9, **Santiago**
Tel: 220222
Telex: JCALCAGNI

COLOMBIA

Instrumentación
Henrik A. Langebaek & Kier S.A.
Carrera 7 No. 48-75
Apartado Aéreo 6287

Bogotá,

1 D.E.
Tel: 269-8877
Telex: 44400
Cable: AARIS Bogotá
Instrumentación
H.A. Langebaek & Kier S.A.
Carrera 63 No. 49-A-31
Apartado 54098

Medellin

Tel: 304475

COSTA RICA

Científica Costarricense S.A.
Avenida 2, Calle 5
San Pedro de Montes de Oca
Apartado 10159
San José
Tel: 24-38-20, 24-08-19
Telex: 2367 GALGUR CR
Cable: GALGUR

ECUADOR

CYEDE Cia. Ltda.
P.O. Box 6423 CCI
Av. Eloy Alfaro 1749
Quito
Tel: 450-975, 243-052
Telex: 2548 CYEDE ED
Cable: CYEDE-Quito

Medical Only
Hospitalar S.A.
Casilla 3590
Robles 625
Quito
Tel: 545-250
Cable: HOSPITALAR-Quito

EL SALVADOR

IPESA
Bulevar de los Heroes 11-48
Edificio Sarah 1148
San Salvador
Tel: 252787

GUATEMALA

IPESA
Avenida Reforma 3-48
Zona 9
Guatemala City
Tel: 316627, 314786, 66471-5,
ext. 9
Telex: 4192 Teletro Gu

MEXICO

Hewlett-Packard Mexicana,
S.A. de C.V.
Av. Periférico Sur No. 6501
Tepepan, Xochimilco
Mexico 23, D.F.
Tel: 905-676-4600
Telex: 017-74-507

Hewlett-Packard Mexicana,
S.A. de C.V.
Ave. Constitución No. 2184
Monterrey, N.L.
Tel: 48-71-32, 48-71-84
Telex: 038-410

PANAMA

Electrónico Balboa, S.A.
Aparatado 4929
Panama 5
Calle Samuel Lewis
Edificio "Alfa," No. 2
Ciudad de Panama
Tel: 64-2700
Telex: 3483103 Curundu,
Canal Zone
Cable: ELECTRON Panama

PERU

Compañía Electro Médica S.A.
Los Flamencos 145
San Isidro Casilla 1030
Lima 1
Tel: 41-4325
Telex: Pub. Booth 25424 SISIDRO
Cable: ELMED Lima

SURINAM

Surtel Radio Holland N.V.
Grote Hofstr. 3-5
P.O. Box 155
Paramaribo
Tel: 72118, 77880
Cable: Surtel

TRINIDAD & TOBAGO

CARTEL
Caribbean Telecoms Ltd.
P.O. Box 732
69 Frederick Street
Port-of-Spain
Tel: 62-53068

URUGUAY

Pablo Ferrando S.A.C.ei.
Avenida Italia 2877
Casilla de Correo 370
Montevideo
Tel: 40-3102
Telex: 702 Public Booth
Para Pablo Ferrando
Cable: RADIUM Montevideo

VENEZUELA

Hewlett-Packard de Venezuela C.A.
P.O. Box 50933
Caracas 105
Los Ruices Norte
3a Transversal
Edificio Segre
Caracas 107
Tel: 239-4133 (20 lines)
Telex: 25146 HEWPACK
Cable: HEWPACK Caracas

FOR AREAS NOT LISTED, CONTACT:

Hewlett-Packard Intertcontinental
3495 Deer Creek Road
Palo Alto, California 94304
Tel: (415) 856-1501
TWX: 910-373-1260
Cable: HEWPACK Palo Alto
Telex: 034-8300, 034-8493

EUROPE, NORTH AFRICA, MIDDLE EAST

AUSTRIA

Hewlett-Packard Ges.m.b.H.
Wehlstrasse 29
P.O. Box 7
A-1205 **Vienna**
Tel: 35-16-21-0
Cable: HEWPACK Vienna
Telex: 13582 / 135066

Hewlett-Packard Ges.m.b.H.
Wehlstrasse, 29
A-1205 **Wien**
Tel: 35-16-21
Telex: 135066

BAHRAIN

Medical Only
Wael Pharmacy
P.O. Box 648
Bahrain
Tel: 45886, 56123
Telex: 8550 WAEJ GJ
Cable: WAELEPHARM

Al Hamidiya Trading and
Contracting
P.O. Box 20074
Manama
Tel: 259978, 259958
Telex: 8895 KALDIA GJ

BELGIUM

Hewlett-Packard Benelux S.A./N.V.
Avenue du Col-Vert, 1,
(Groenkraaglaan)
B-1170 **Brussels**
Tel: (02) 660 50 50
Cable: PALOBEN Brussels
Telex: 23-494 paloben bru

CYPRUS

Kyronics
19 Gregorios Xenopoulos Street
P.O. Box 1152
Nicosia
Tel: 45628 / 29
Cable: Kyronics Pandehis
Telex: 3018

CZECHOSLOVAKIA

Hewlett-Packard
Obchodní zastupitelství v CSSR
Pisemny styk
Post. schranka 27
CS 118 01 **Praha** 011
CSSR
Vyvojova a Provozní Zakladna
Vyzkumnych Ustavu v Bechovicich
CSSR-25097 **Bechovice u Prahy**
Tel: 89 93 41
Telex: 12133

INSTITUTE OF MEDICAL BIONICS

Vyskumny Ustav Lekarскеj Bioniky
Jedlova 6
CS-88346 **Bratislava-Kramare**
Tel: 44-551
Telex: 93229

DENMARK

Hewlett-Packard A/S
Datavej 52
DK-3460 **Birkerød**
Tel: (02) 81 66 40
Cable: HEWPACK AS
Telex: 37409 hpas dk

Hewlett-Packard A/S
Navervej 1
DK-8600 **Silkeborg**
Tel: (06) 82 71 66
Telex: 37409 hpas dk
Cable: HEWPACK AS

EGYPT

I.E.A.
International Engineering
Associates
24 Hussein Hegazi Street
Kasr-el-Aini
Cairo
Tel: 23 829,
Telex: 93830
Cable: INTENGASSO
SAMITRO
Sami Amin Trading Office
18 Abdel Aziz Gawish
Abdine-Cairo
Tel: 24932
Cable: SAMITRO CAIRO

FINLAND

Hewlett-Packard Oy
Revontulentie, 7
SF-02100 **Espoo** 10
Tel: (90) 455 0211
Cable: HEWPACKOY
Telex: 121563 hewpa sf

FRANCE

Hewlett-Packard France
Zone d'activités de Courtaboeuf
Avenue des Tropiques
Boite Postale 6
91401 **Orsay**-Cédex
Tel: (1) 907 78 25
TWX: 600048F

Hewlett-Packard France
Chemin des Mouilles
B.P. 162
69130 **Ecully**
Tel: (78) 33 81 25
TWX: 310617F

Hewlett-Packard France
20, Chemin de La Capière
31081 **Toulouse**
Le Mirail-Cédex
Tel: (61) 40 11 12

Hewlett-Packard France
Place Romée de Villeneuve
13100 **Aix-en-Provence**
Tel: (42) 59 41 02
TWX: 410770F

Hewlett-Packard France
2, Allée de la Bourgonnette
35100 **Rennes**
Tel: (99) 51 42 44
TWX: 740912F

Hewlett-Packard France
18, rue du Canal de la Marne
67300 **Schiltigheim**
Tel: (88) 83 08 10
TWX: 890141F

Hewlett-Packard France
Immeuble péricentre
rue van Gogh
59650 **Villeneuve D'Ascq**
Tel: (20) 91 41 25
TWX: 160124F

Hewlett-Packard France
Bâtiment Ampère
Rue de la Commune de Paris
B.P. 300
93153 **Le Blanc Mesnil**-Cédex
Tel: (01) 931 88 50
Telex: 211032F

Hewlett-Packard France
Av. du Pdt. Kennedy
33700 **Mérignac**
Tel: (56) 97 01 81

Hewlett-Packard France
Immeuble Lorraine
Boulevard de France
91035 **Evry**-Cédex
Tel: 077 96 60
Telex: 692315F

Hewlett-Packard France
23 Rue Lothaire
57000 **Metz**
Tel: (87) 65 53 50

GERMAN FEDERAL REPUBLIC
Hewlett-Packard GmbH
Vertriebszentrale Frankfurt
Bernner Strasse 117
Postfach 560 140
D-6000 **Frankfurt** 56
Tel: (06011) 50041
Cable: HEWPACKSA Frankfurt

Telex: 04 13249 hpfm d
Hewlett-Packard GmbH
Technisches Büro Böblingen
Herrenberger Strasse 110
D-7030 **Böblingen**,
Württemberg
Tel: (07031) 667-1
Cable: HEWPACK Böblingen
Tel: 07265739 bbn

Hewlett-Packard GmbH
Technisches Büro Düsseldorf
Emanuel-Leutze-Str. 1 (Seestern)
D-4000 **Düsseldorf**
Tel: (0211) 5971-1
Telex: 085/86 533 hppd d

Hewlett-Packard GmbH
Technisches Büro Hamburg
Kapstadtring 5
D-2000 **Hamburg** 60
Tel: (040) 63804-1
Cable: HEWPACKSA Hamburg
Telex: 21 63 032 hphh d

Hewlett-Packard GmbH
Technisches Büro Hannover
Am Grossmarkt 6
D-3000 **Hannover** 91
Tel: (0511) 46 60 01
Telex: 092 3259

Hewlett-Packard GmbH
Technisches Büro Nürnberg
Neumeyerstrasse 90
D-8500 **Nürnberg**
Tel: (0911) 52 20 83
Telex: 0623 860

SALES OFFICES

(cont.)

EUROPE, NORTH AFRICA, MIDDLE EAST

Hewlett-Packard GmbH
Technisches Büro München
Eschenstrasse 5
D-8021 Taufkirchen
Tel: (089) 6117-1
Telex: 0524985

Hewlett-Packard GmbH
Technisches Büro Berlin
Kaithstrasse 2-4
D-1000 Berlin 30
Tel: (030) 24 90 86
Telex: 018 3405 hpbln d

GREECE
Kostas Karayannis
8 Omirou Street
Athens 133
Tel: 32 30 303/32/37 731
Telex: 21 59 62 RKAR GR
Cable: RAKAR ATHENS

ICELAND
Medical Only
Elding Trading Company inc.
Hafnarvöi - Tryggvagötu
P.O. Box 895

IS-REYKJAVIK
Tel: 1 58 20/1 63 03
Cable: EL DING Reykjavik

IRELAND
Hewlett-Packard Ltd.
King Street Lane
Winnersh, Wokingham
Berkshire, RG11 5AR
GB-England
Tel: (0734) 78 47 74
Telex: 847178
Cable: Hewpie London

Hewlett-Packard Ltd.
Kestrel House
Cianwilliam Place
Lower Mount Street
Dublin 2, Eire

Hewlett-Packard Ltd.
2C Avonberg Ind. Est.
Long Mile Road
Dublin 12
Tel: 514322/514224
Telex: 30439

Medical Only
Cardiac Services (Ireland) Ltd.
Kilmore Road
Artane
Dublin 5, Eire
Tel: (01) 315820

Medical Only
Cardiac Services Co.
95A Finaghy Rd. South
Belfast BT10 0BY
GB-Northern Ireland
Tel: (0232) 625566
Telex: 747626

ISRAEL
Electronics Engineering Div.
of Motorola Israeli Ltd.
16, Kremenetski Street
P.O. Box 25018
Tel-Aviv
Tel: 38973
Telex: 33569, 34164
Cable: BASTEL Tel-Aviv

ITALY
Hewlett-Packard Italiana S.p.A.
Via G. Di Vittorio, 9
20063 **Cernusco Sul Naviglio (MI)**
Tel: (2) 903891
Telex: 334632 HEWPAKIT
Hewlett-Packard Italiana S.p.A.
Via Turazza, 14
35100 **Padova**
Tel: (49) 664888
Telex: 430315 HEWPAKIT

Hewlett-Packard Italiana S.p.A.
Via G. Armellini 10
I-00143 **Roma**
Tel: (06) 54 69 61
Telex: 610514
Cable: HEWPAKIT Roma
Hewlett-Packard Italiana S.p.A.
Corso Giovanni Lanza 94
I-10133 **Torino**
Tel: (011) 659308
Telex: 221079

Hewlett-Packard Italiana S.p.A.
Via Principe Nicola 43 G/C
I-95126 **Catania**
Tel: (095) 37 05 04
Telex: 970291
Hewlett-Packard Italiana S.p.A.
Via Nuova san Rocco A
Capadimitone, 62A
80131 **Napoli**
Tel: (081) 710698

Hewlett-Packard Italiana S.p.A.
Via Martin Luther King, 38/111
I-40132 **Bologna**
Tel: (051) 402394
Telex: 511630

JORDAN
Mouasher Cousins Co.
P.O. Box 1387
Amman
Tel: 24907/39907
Telex: SABCO JO 1456
Cable: MOUASHERCO

KUWAIT
Al-Khaldiya Trading & Contracting
P.O. Box 830-Safat
Kuwait
Tel: 42 4910/41 1726
Telex: 2481 Areeg kt
Cable: VISCOUNT

LUXEMBURG
Hewlett-Packard Benelux S.A./N.V.
Avenue du Col-Vert, 1
(Groenraagliaan)
B-1170 **Brussels**
Tel: (02) 660 5050
Cable: PALOBEN Brussels
Telex: 23 494

MOROCCO
Dolbeau
81 rue Karatchi
Casablanca
Tel: 3041 82
Telex: 23051/22822
Cable: MATERIO

Gerep
2, rue d'Agadir
Boite Postal 156
Casablanca
Tel: 272093/5
Telex: 23 739
Cable: GEREP-CASA

NETHERLANDS
Hewlett-Packard Benelux N.V.
Van Heuven Goedhartlaan 121
P.O. Box 667
1181KK **Amstelveen**
Tel: (20) 47 20 21
Cable: PALOBEN Amsterdam
Telex: 13 216

NORWAY
Hewlett-Packard Norge A/S
Ostendalen 18
P.O. Box 34
1345 **Osteraas**
Tel: (02) 1711 80
Telex: 16621 hpnas n

Hewlett-Packard Norge A/S
Nygaardsgaten 114
P.O. Box 4210
5013 Nygaardsgaten,
Bergen
Tel: (05) 21 97 33

POLAND
Biuro Informacji Technicznej
Hewlett-Packard
Ul Stawki 2, 6P
PL00-950 **Warszawa**
Tel: 39 59 62, 39 51 87
Telex: 81 24 53

PORTUGAL
Telectra-Empresa Técnica de Equipamentos Eléctricos S.a.r.l.
Rua Rodrigo da Fonseca 103
P.O. Box 2531
P-Lisbon 1
Tel: (19) 68 60 72
Cable: TELECTRA Lisbon
Telex: 12598

Medical Only
Mundinter
Intercambio Mundial de Comercio S.a.r.l.
P.O. Box 2761
Avenida Antonio Augusto de Aguiar 138
P-Lisbon
Tel: (19) 53 21 31/7
Telex: 16691 munter p
Cable: INTERCAMBIO Lisbon

QATAR
Nasser Trading & Contracting
P.O. Box 1563
Doha
Tel: 22170
Telex: 4439 NASSER
Cable: NASSER

ROMANIA
Hewlett-Packard Reprezentanta
Bd.n. Balcescu 16
Bucuresti
Tel: 15 80 23/13 88 85
Telex: 10440

SAUDI ARABIA
Modern Electronic Establishment (Head Office)
Jeddah
Tel: 27 798
Telex: 40035
Cable: ELECTA JEDDAH

Modern Electronic Establishment (Branch)
P.O. Box 2728
Riyadh
Tel: 62596/66232
Telex: 202049

Modern Electronic Establishment (Branch)
P.O. Box 193
Al-Khobar
Tel: 44678-44813
Telex: 670136
Cable: ELECTA AL-KHOBAR

SPAIN
Hewlett-Packard Española, S.A.
Calle Jerez 3
E-Madrid 16
Tel: (1) 458 26 00 (10 lines)
Telex: 23515 hpe

Hewlett-Packard Española S.A.
Colonia Mirasierra
Edificio Juban
c/o Costa Brava, 13
Madrid 34

Hewlett-Packard Española, S.A.
Milanesado 21-23
E-Barcelona 17
Tel: (3) 203 6200 (5 lines)
Telex: 52603 hpbe e

Hewlett-Packard Española, S.A.
Av Ramón y Cajal, 1
Edificio Sevilla, planta 9°
E-Sevilla 5
Tel: 64 44 54/58

Hewlett-Packard Española S.A.
Edificio Albia II 7° B
E-Bilbao 1
Tel: 23 83 06/23 82 06

Hewlett-Packard Española S.A.
C/Ramon Gordillo 1 (Entlo.)
E-Valencia 10
Tel: 96-361.13.54/361.13.58

SWEDEN
Hewlett-Packard Sverige AB
Enighetsvägen 3, Fack
S-161 **Bromma 20**
Tel: (08) 730 05 50
Telex: 10721
Cable: MEASUREMENTS Stockholm

Hewlett-Packard Sverige AB
Frötällsgatan 30
S-421 32 **Västra Frölunda**
Tel: (031) 49 09 50
Telex: 10721 via Bromma office

SWITZERLAND
Hewlett-Packard (Schweiz) AG
Zürcherstrasse 20
P.O. Box 307
CH-8952 **Schlieren-Zürich**
Tel: (01) 7305240
Telex: 53933 hpag ch
Cable: HPAG CH

Hewlett-Packard (Schweiz) AG
Château Bloc 19
CH-1219 **Le Lignon-Geneva**
Tel: (022) 96 03 22
Telex: 27333 hpag ch
Cable: HEWPAKAG Geneva

SYRIA
General Electronic Inc.
Nuri Basha-Ahnaf Ebn Kays Street
P.O. Box 5781
Damascus
Tel: 33 24 87
Telex: 11215 ITIKAL
Cable: ELECTROBOR DAMASCUS

Medical only
Sawah & Co.
Place Azme
B.P. 2308
Damascus
Tel: 16 367-19 697-14 268
Telex: 11304 SATACO SY
Cable: SAWAH, DAMASCUS

Suleiman Hilal El Milawi
P.O. Box 2528
Mamoun Bitar Street, 56-58
Damascus
Tel: 11 46 63
Telex: 114720
Cable: HILAL DAMASCUS

TUNISIA
Tunisie Electronique
31 Avenue de la Liberte
Tunis
Tel: 280 144
Corema
1 ter. Av. de Carthage
Tunis
Tel: 253 821
Telex: 12319 CABAM TN

TURKEY
TEKNIM Company Ltd.
Riza Sah Pehevi
Caddesi No. 7
Kavaklidere, **Ankara**
Tel: 275800
Telex: 42155

Teknim Com., Ltd.
Barbaros Bulvari 55/12
Besikyas, **Istanbul**
Tel: 613 546
Telex: 23540

E.M.A.
Muhendislik Kolektif Sirketi
Mediha Eldem Sokak 41/6
Yüksel Caddesi
Ankara
Tel: 17 56 22
Cable: EMATRADE/Ankara

Yilmaz Ozyurek
Milli Mudafaa Cad 16/6
Kizilay
Ankara
Tel: 25 03 09 - 17 80 26
Telex: 42576 OZEK TR
Cable: OZYUREK ANKARA

UNITED ARAB EMIRATES
Emitac Ltd. (Head Office)
P.O. Box 1641
Sharjah
Tel: 35412/1/3
Telex: 8136

Emitac Ltd. (Branch Office)
P.O. Box 2711
Abu Dhabi
Tel: 331370/1

UNITED KINGDOM
Hewlett-Packard Ltd.
King Street Lane
Winnersh, Wokingham
Berkshire RG11 5AR
GB-England
Tel: (0734) 784774
Telex: 84 71 78/9
Hewlett-Packard Ltd.
Fournier House,
257-263 High Street
London Colney
St. Albans, Herts
GB-England
Tel: (0727) 24400
Telex: 1-8952716

Hewlett-Packard Ltd.
Trafalgar House
Navigation Road
Altrincham
Cheshire WA14 1NU
GB-England
Tel: (061) 928 6422
Telex: 668068

Hewlett-Packard Ltd.
Lygon Court
Hereward Rise
Dudley Road
Halesowen,
West Midlands, B62 8SD
GB-England
Tel: (021) 501 1221
Telex: 339105

Hewlett-Packard Ltd.
Wedge House
799, London Road
Thornton Heath
Surrey, CR4 6XL
GB-England
Tel: (01) 684-0103/8
Telex: 946825

Hewlett-Packard Ltd.
14 Wesley St
Castleford
Yorks WF10 1AE
Tel: (0977) 550016
TWX: 5557335

Hewlett-Packard Ltd.
Tradax House
St. Mary's Walk
Maidenhead
Berkshire, SL6 1ST
GB-England

Hewlett-Packard Ltd.
Morley Road
Staplehill
Bristol, BS16 4QT
GB-England

Hewlett-Packard Ltd.
South Queensferry
West Lothian, EH30 9TG
GB-Scotland
Tel: (031) 331 1188
Telex: 72682

Hewlett-Packard Ltd.
Kestrel House
Cianwilliam Place
Lower Mount Street
Dublin 2, Eire

Hewlett-Packard Ltd.
2C Avonberg Ind. Est.
Long Mile Road
Dublin 12
Tel: 514322/514224
Telex: 30439

USSR
Hewlett-Packard Representative Office
USSR
Pokrovsky Boulevard 4/17-kw 12
Moscow 101000
Tel: 294.20.24
Telex: 7825 hewpak su

YUGOSLAVIA
Iskra Commerce, n.s.o.
Zastopstvo Hewlett-Packard
Obilicev Venac 26
YU 11000 **Beograd**
Tel: 636-955
Telex: 11530

Iskra Commerce, n.s.o.
Zastopstvo Hewlett-Packard
Miklosiceva 38/III
YU-61000 **Ljubljana**
Tel: 321-674, 315-879
Telex: 31583



SALES OFFICES

(cont.)

EUROPE, NORTH AFRICA, MIDDLE EAST

SOCIALIST COUNTRIES NOT SHOWN, PLEASE CONTACT:

Hewlett-Packard Ges.m.b.H.
Handelskai 52
P.O. Box 7
A-1205 Vienna, Austria
Tel: (0222) 35 16 21 to 27
Cable: HEWPAK Vienna
Telex: 75923 hewpak a

MEDITERRANEAN AND MIDDLE EAST COUNTRIES NOT SHOWN, PLEASE CONTACT:

Hewlett-Packard S.A.
Mediterranean and Middle East
Operations
35, Kolokotroni Street
Platia Kefalliarou
GR-11526 Athens, Greece
Tel: 800359/429
Telex: 21-6588
Cable: HEWPACKSA Athens

FOR OTHER AREAS NOT LISTED, CONTACT:

Hewlett-Packard S.A.
7, rue du Bois-du-Lan
P.O. Box
CH-1217 Meyrin 2 - Geneva
Switzerland
Tel: (022) 82 70 00
Cable: HEWPACKSA Geneva
Telex: 2 24 86

UNITED STATES

ALABAMA

P.O. Box 4207
8290 Whitesburg Dr.
Huntsville 35802
Tel: (205) 881-4592
8933 E. Roebuck Blvd.
Birmingham 35206
Tel: (205) 836-2203. 2

ARIZONA

2336 E. Magnolia St.
Phoenix 85034
Tel: (602) 244-1361
2424 East Aragon Rd.
Tucson 85706
Tel: (602) 889-4661

ARKANSAS

Medical Service Only
P.O. Box 5646
Brady Station
Little Rock 72215
Tel: (501) 376-1844

CALIFORNIA

1579 W. Shaw Ave.
Fresno 93771
Tel: (209) 224-0582
1430 East Orangethorpe Ave.
Fullerton 92631
Tel: (714) 870-1000
3939 Lankershim Boulevard
North Hollywood 91604
Tel: (213) 877-1282
TWX: 910-499-2671

5400 West Rosecrans Blvd.
P.O. Box 92105
World Way Postal Center
Los Angeles 90009
Tel: (213) 776-7500
TWX: 910-325-6608

***Los Angeles**
3200 Hillview Av
Palo Alto, CA 94304
Tel: (408) 988-7000

3003 Scott Boulevard
Santa Clara 95050
Tel: (408) 988-7000
TWX: 910-338-0518

***Ridgecrest**
Tel: (714) 446-6165

646 W. North Market Blvd.
Sacramento 95834
Tel: (916) 929-7222

9806 Aero Drive
P.O. Box 23333
San Diego 92123
Tel: (714) 279-3200

***Tarzana**
Tel: (213) 705-3344

COLORADO
5600 DTC Parkway
Englewood 80110
Tel: (303) 771-3455

CONNECTICUT
47 Barnes Industrial Road
Barnes Park South
Wallingford 06492
Tel: (203) 265-7801

FLORIDA
P.O. Box 24210
2727 N.W. 62nd Street
Ft. Lauderdale 33309
Tel: (305) 973-2600

4080 Woodcock Drive # 132
Brownell Building
Jacksonville 32207
Tel: (904) 398-0663

P.O. Box 13910
6177 Lake Ellenor Dr.
Orlando 32809
Tel: (305) 859-2900

P.O. Box 12826
Suite 5, Bldg. 1
Office Park North
Pensacola 32575
Tel: (904) 476-8422

Computer Systems Only
110 South Hoover Blvd.
Suite 120
Tampa 33609
Tel: (813) 872-0900

GEORGIA
P.O. Box 105005
450 Interstate North Parkway
Atlanta 30348
Tel: (404) 955-1500
TWX: 810-766-4890

Medical Service Only
***Augusta** 30903
Tel: (404) 736-0592

P.O. Box 2103
1172 N. Davis Drive
Warner Robins 31098
Tel: (912) 922-0449

HAWAII
2875 So. King Street
Honolulu 96826
Tel: (808) 955-4455

ILLINOIS
5201 Tollview Dr.
Rolling Meadows
60008
Tel: (312) 255-9800
TWX: 910-687-2260

INDIANA
7301 North Shadeland Ave.
Indianapolis 46250
Tel: (317) 842-1000
TWX: 810-260-1797

IOWA
2415 Heinz Road
Iowa City 52240
Tel: (319) 351-1020

KENTUCKY
10170 Linn Station Road
Suite 525
Louisville 40223
Tel: (502) 426-0100

LOUISIANA
P.O. Box 1449
3229-39 Williams Boulevard
Kenner 70063
Tel: (504) 443-6201

MARYLAND
7121 Standard Drive
Parkway Industrial Center
Hanover 21076
Tel: (301) 796-7700
TWX: 710-862-1943

2 Choke Cherry Road
Rockville 20850
Tel: (301) 948-6370
TWX: 710-828-9684

MASSACHUSETTS
32 Hartwell Ave.
Lexington 02173
Tel: (617) 861-8960
TWX: 710-326-6904

MICHIGAN
23855 Research Drive
Farmington Hills 48024
Tel: (313) 476-6400

724 West Centre Ave.
Kalamazoo 49002
Tel: (616) 323-8362

MINNESOTA

2400 N. Prior Ave.
St. Paul 55113
Tel: (612) 636-0700

MISSISSIPPI
322 N. Mari Plaza
Jackson 39206
Tel: (601) 982-9363

MISSOURI
11131 Colorado Ave.
Kansas City 64137
Tel: (816) 763-8000
TWX: 910-771-2087

1024 Executive Parkway
St. Louis 63141
Tel: (314) 878-0200

NEBRASKA
Medical Only
7101 Mercy Road
Suite 101
Omaha 68106
Tel: (402) 392-0948

NEVADA
***Las Vegas**
Tel: (702) 736-6610

NEW JERSEY
W. 120 Century Rd.
Paramus 07652
Tel: (201) 265-5000
TWX: 710-990-4951

Crystal Brook Professional Building
Route 35
Eatontown 07724
Tel: (201) 542-1384

NEW MEXICO
P.O. Box 11634
Station E
11300 Lomas Blvd., N.E.
Albuquerque 87123
Tel: (505) 292-1330
TWX: 910-989-1185

156 Wyatt Drive
Las Cruces 88001
Tel: (505) 526-2484
TWX: 910-9983-0550

NEW YORK

6 Automation Lane
Computer Park
Albany 12205
Tel: (518) 458-1550
TWX: 710-444-4961

650 Perinton Hill Office Park
Fairport 14450
Tel: (716) 223-9950
TWX: 510-253-0092

No. 1 Pennsylvania Plaza
55th Floor
34th Street & 8th Avenue
New York 10001
Tel: (212) 971-0800

5858 East Molloy Road
Syracuse 13211
Tel: (315) 455-2486

1 Crosswicks Park West
Woodbury 11797
Tel: (516) 921-0300
TWX: 510-221-2183

NORTH CAROLINA
5605 Roanne Way
Greensboro 27405
Tel: (919) 852-1800

OHIO

Medical/Computer Only
Bldg. 300
1313 E. Kemper Rd.
Cincinnati 45426
16500 Sprague Road
Cleveland 44130

Tel: (216) 243-7300
TWX: 810-423-9430

330 Progress Rd.
Dayton 45449
Tel: (513) 859-8202

1041 Kingsmill Parkway
Columbus 43229
Tel: (614) 436-1041

OKLAHOMA

P.O. Box 32008
6301 N. Meridan Avenue
Oklahoma City 73112
Tel: (405) 721-0200

9920 E. 42nd Street
Suite 121
Tulsa 74145
Tel: (918) 665-3300

OREGON

17890 S.W. Lower Boones Ferry
Road
Tualatin 97062
Tel: (503) 620-3350

PENNSYLVANIA
111 Zeta Drive
Pittsburgh 15238
Tel: (412) 782-0400

1021 8th Avenue
King of Prussia Industrial Park
King of Prussia 19406
Tel: (215) 265-7000
TWX: 510-660-2670

PUERTO RICO
Hewlett-Packard Inter-Américas
Puerto Rico Branch Office
Calle 272,
Edif. 203 Urg. Country Club
Carolina 00924
Tel: (809) 762-7255
Telex: 345 0514

SOUTH CAROLINA
P.O. Box 6442
6941-0 N. Trenholm Road
Columbia 29260
Tel: (803) 782-6493

TENNESSEE

8914 Kingston Pike
Knoxville 37922
Tel: (615) 523-0522

3027 Vanguard Dr.
Director's Plaza
Memphis 38131
Tel: (901) 346-8370

***Nashville**
Medical Service Only
Tel: (615) 244-5448

TEXAS

4171 North Mesa
Suite C110
El Paso 79902
Tel: (915) 533-3555

P.O. Box 1270
201 E. Arapaho Rd.
Richardson 75080
Tel: (214) 231-6101

P.O. Box 42816
10535 Harwin Dr.
Houston 77036
Tel: (713) 776-6400

***Lubbock**
Medical Service Only
Tel: (806) 799-4472

205 Billy Mitchell Road
San Antonio 78226
Tel: (512) 434-8241

UTAH

2160 South 3270 West Street
Salt Lake City 84119
Tel: (801) 972-4711

VIRGINIA

P.O. Box 9669
2914 Hungry Springs Road
Richmond 23228
Tel: (804) 285-3431

WASHINGTON

Computer Systems/Medical Only
Airport Executive Center
Suite 111
5700 Thurston Avenue
Virginia Beach 23455
Tel: (804) 460-2471

*WEST VIRGINIA

Medical/Analytical Only
4604 Mac Corkle Ave., S.E.
Charleston 25304
Tel: (304) 925-0492

WISCONSIN
150 South Sunny Slope Road
Brookfield 53005
Tel: (414) 784-8800

FOR U.S. AREAS NOT LISTED:

Contact the regional office
nearest you:
Atlanta, Georgia... North Holly-
wood, California... Rockville,
Maryland... Rolling Meadows,
Illinois. Their complete addresses
are listed above.

*Service Only



